

USER MANUAL WEIGHT INDICATOR

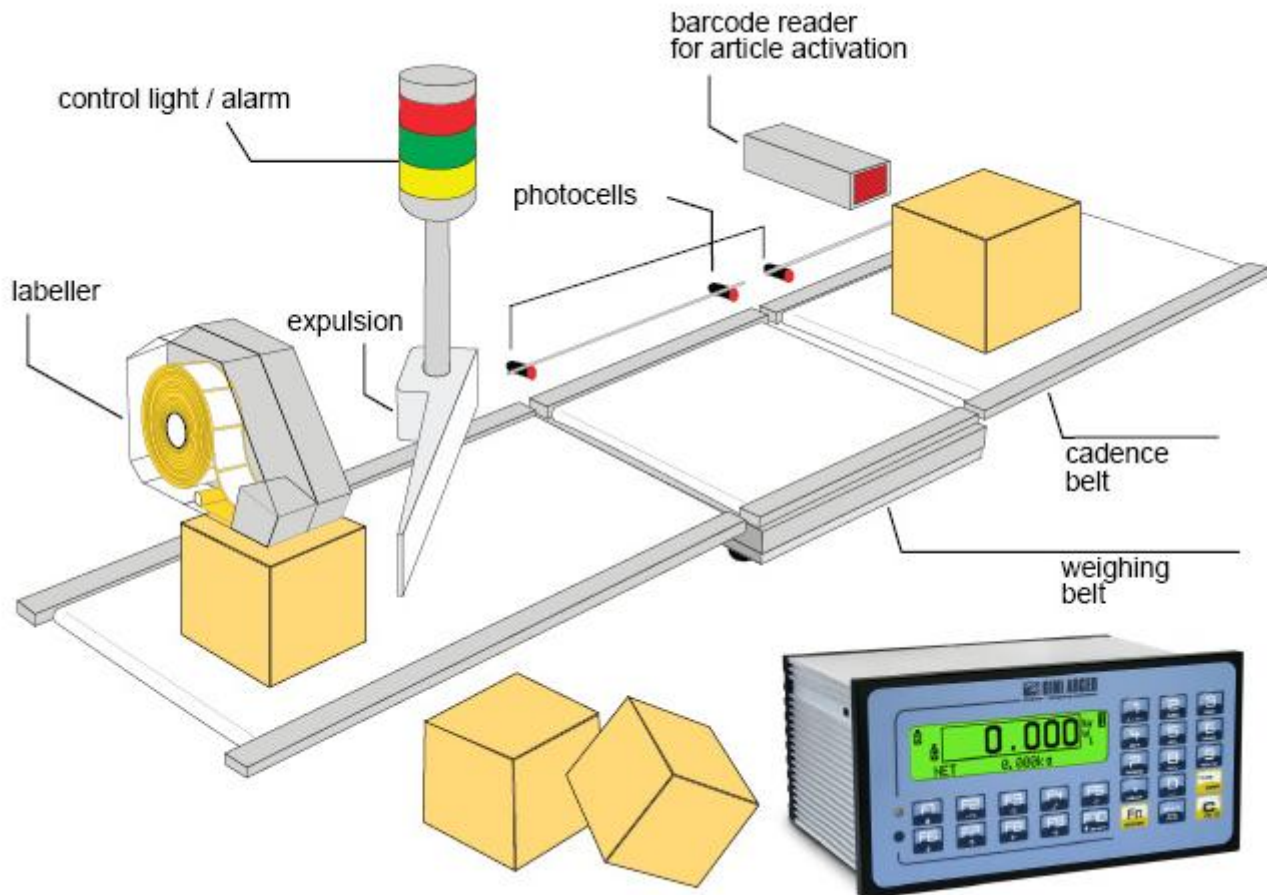

E-CHECK: STATIC OR DYNAMIC WEIGHT CONTROL ON BELT



3590EXT, CPWE series indicator



INDEX

1. INTRODUCTION	4
2. MAIN TECHNICAL SPECIFICATIONS	5
2.1 EXTRA ACCESSORIES	6
2.2 SYMBOLS	6
3. INSTALLATION	7
3.1 DRILLING TEMPLATE, CASE AND DIMENSION	7
3.2 POWER SUPPLY & START-UP	8
3.3 CONNECTION TO THE BATTERY POWERED PRINTER	9
4. FUNCTION PANEL KEYS	10
4.1 "2ndF" KEY: SECOND FUNCTION OF THE KEYS	11
4.2 ENTERING ALPHANUMERIC TEXT	11
4.3 DISABLING THE KEYBOARD	12
4.4 HELP MENU	12
4.5 INDICATOR CONNECTED TO PC KEYBOARD	12
4.5.1 DIRECT COMPILATION OF INPUT TEXT	13
4.6 REMOTE CONTROL	13
4.6.1 RADIO REMOTE CONTROL TO ASSOCIATE	13
4.6.2 RADIO REMOTE CONTROL	13
5. DISPLAY FUNCTIONS	14
5.1 WEIGHT ZOOM	15
5.2 STATUS INDICATORS	15
5.2.1 BATTERY LEVEL INDICATION	16
5.3 MODIFICATION OF THE DISPLAYED DATA	16
5.3.1 SYSTEM STATUS VISUALISATION	20
5.4 MESSAGES	21
6. SCALE ZERO FUNCTION	23
7. TARE FUNCTIONS	23
7.1 SEMIAUTOMATIC TARE	23
7.2 PRESET TARE	23
7.3 CALCULATED MANUAL TARE	23
7.4 TARE CANCELLATION	23
7.5 LOCKED/UNLOCKED TARE	23
7.6 LIMITATION OF THE TARE FUNCTIONS	24
7.7 LINKING A KNOWN TARE VALUE TO AN ARTICLE	24
8. MULTIRANGE FUNCTION	24
9. DISPLAY OF METRIC DATA (inFO)	24
10. FILLING IN THE INPUT TEXT	26
11. ARTICLES DATABASE	27
11.1 ENTRY	27
11.2 MODIFICATION	28
11.3 CANCELLATION	28
11.4 PRINTING	28
11.5 SELECTION/UNSELECTION	28
11.6 ENTRY, MODIFICATION AND QUICK SELECTION OF ARTICLE 000	28
11.7 HELP	28
12. DATABASE ACCESS PASSWORD	29
13. WEIGHING PROCEDURES	29
13.1 SYSTEM STATUS CONTROL	29
13.2 ENABLING / DISABLING THE WEIGHING CYCLE	29
13.3 DESCRIPTION OF THE CYCLE PHASES	30
13.3.1 WEIGHT ACQUISITION	30
13.3.1.1 AT HALT WITH 1 PHOTO CELL	30
13.3.1.2 IN MOTION WITH 1 PHOTO CELL	31
13.3.1.3 IN MOTION WITH 2 PHOTO CELLS	31
13.3.1.4 AT HALT WITHOUT PHOTO CELLS	32

13.3.1.5 IN MOTION WITH NO PHOTO CELL	33
13.3.2 TOLERANCE CHECK	34
13.3.2.1 CHECKING WITH ARTICLE AND T1,T2,T3 TOLERANCE SETTING.....	35
13.3.2.2 CHECKING WITH ARTICLE AND MINIMUM AND MAXIMUM THRESHOLD SETTING	35
13.3.2.3 CHECKING WITHOUT ARTICLE AND FAST MINIMUM AND MAXIMUM THRESHOLDS SETTING	36
13.3.2.4 DETERMINATION OF TOLERANCE RANGE.....	36
13.3.2.5 CHECKING QUANTITIES IN ml	37
13.3.2.6 AUTOMATIC TARGET RECALCULATION AFTER N WEIGHS WITHIN TOLERANCE	37
13.3.3 CORRECTION OF THE OUT OF TOLERANCE WEIGHT	38
13.3.4 TOTALIZATION	38
13.3.4.1 TOTALIZATION OF ONLY THE WEIGHS WITHIN TOLERANCE	39
13.3.4.2 VISUALISATION AND CLEARING OF THE ACCUMULATED TOTALS.....	39
13.3.4.3 CLEARING AND AUTOMATIC PRINTING OF THE PARTIAL TOTAL AFTER N WEIGHS	39
13.3.4.4 ADDITIONAL VALUE.....	39
13.3.4.5 TICKET PROGRESSIVE	40
13.3.5 WEIGH RESULT INDICATION AND ENABLING OF THE LINKED OUTPUTS	40
13.3.6 STOP AND RESTART OF THE BELTS	42
13.3.6.1 STOP OF BELTS FOR WEIGH OUT OF TOLERANCE / MANUAL EXPULSION.....	42
13.3.6.2 STOP OF BELTS AFTER EVERY WEIGH.....	42
13.3.6.3 STOP OF BELTS AFTER A NUMBER OF WEIGHS OUT OF TOLERANCE.....	42
13.3.7 EVACUATION AND AUTOMATIC EXPULSION	42
13.3.8 WEIGHING BELT AUTOZERO	42
13.4 CYCLE LOCK AND INTERRUPTION OF THE WEIGH (NON WEIGHED PACK)	44
13.4.1 DOWNSTREAM BLOCK	44
13.4.2 EMERGENCY / MOTOR LOCK.....	44
13.4.3 UNDERLOAD / OVERLOAD WEIGHT LOCK	44
13.5 CYCLE RESTORAL AFTER POWER OUTAGE	44
13.6 MANAGEMENT OF CADENCE PHOTOCCELL AND BELT	45
13.7 ALARM OUTPUT MANAGEMENT	45
14. PRINTOUTS.....	46
14.1 LINKING OF THE FORMATS TO THE PRINT FUNCTIONS	48
14.1.1 QUICK LINKING OF THE FORMATS	49
14.2 LOT WEIGHS REPORT	49
14.2.1 PRINTING OF THE HEADING	49
14.2.2 TOTALIZATION	50
14.2.3 TOTAL LOT	50
14.3 REPETITION OF THE LAST EXECUTED PRINTOUT	50
14.4 STANDARD PRINTING FORMATS	50
15. OTHER FUNCTIONS.....	53
15.1 DIAGNOSTIC PERIPHERALS	53
15.2 COM DATA DIAGNOSTIC	53
15.3 CALCULATOR	54
15.3.1 HELP	54
15.4 DISPLAY OF NET WEIGHT WITH SENSITIVITY X 10 (for testing use during calibration).....	54
15.5 SETTING DATE / TIME.....	54
16. FUNCTIONING WITH ALIBI MEMORY	55
16.1 READING OF THE WEIGHS CARRIED OUT	56
16.2 SERIAL COMMANDS FOR MANAGING THE ALIBI MEMORY:.....	56
16.2.1 REQUEST WEIGHT VALUE WITH WEIGH ID.....	56
16.2.2 STRING FORMAT (WEIGHT/ID).....	57
16.2.3 WEIGH READING	58
16.2.4 ALIBI MEMORY CANCELLATION (only with non approved instrument).....	58
DECLARATION OF CONFORMITY	59
WARRANTY	59

1. INTRODUCTION

This manual was created to help you install and learn all about the functional possibilities of the purchased indicator.

Besides having the standard features of a high precision scale, the instrument manages static and dynamic weighing on belts.

The Input/Output board allows the instrument to control various external devices, receive external commands, and to communicate with a personal computer or to be inserted in a network of weight indicators controlled by a PC.



This instrument is covered by a warranty and **MUST NOT BE OPENED BY THE USER** for any reason whatsoever. Any attempt to repair or modify the unit could expose the user to a risk of electric shock and will void the entire warranty. Any problem with the unit or with the system must be communicated to the manufacturer or to the dealer where it was purchased. In any case, **DISCONNECT THE POWER SUPPLY** before taking any action.

Do not pour liquids on the weight indicator.

Do not use solvents to clean the weight indicator.

Do not expose the instrument to direct sunlight nor place it near heat sources.

Place the weight indicator and the platform on a non vibrating base.

READ SECTION "INSTALLATION" CAREFULLY AND IMPLEMENT THE INFORMATION FOUND THERE

Do not install in any area where a risk of explosion exists



The crossed-out wheeled bin on the product means that at the product end of life, it must be taken to separate collection or to the reseller when a new equivalent type of equipment is purchased. The adequate differentiated refuse collection in having the product recycled, helps to avoid possible negative effects on the environment and health and supports the recycling of the materials of which the equipment is made. The unlawful disposal of the product by the user will entail fines foreseen by the current regulations.

NOTE FOR THE USER

Please take note that when "**TECH.MAN.REF.**" is mentioned, this refers to the Technical manual which may be obtained from the reseller.

2. MAIN TECHNICAL SPECIFICATIONS

POWER SUPPLY	- 8 ÷ 40 Vdc - 6 Vdc from external rechargeable battery (optional).
MAXIMUM POWER	16 VA.
OPERATING TEMPERATURE	From -15 to +40 °C (from 5 to 104°F).
CONVERTER	24-bit Sigma Delta.
CONVERSION SPEED	Up to 400 conv./sec with automatic selection.
INPUT SIGNAL RANGE	0,6 mV/V - 3,2 mV/V.
MINIMUM VOLTAGE PER DIVISION	0.3 μV (approved instrument); 0.03 μV (non-approved instrument).
AUTOMATIC ZERO TRACKING	Only in gross mode, programmable at +/- ¼, ½, 1, 2 divisions.
ZERO RANGE	Configurable up to +/- 50% of max load capacity.
AUTOMATIC ZERO AT START-UP	Configurable up to +/- 50% of max capacity.
LOAD CELL POWER SUPPLY	5Vdc ± 5%, 120mA (up to 8 350-Ohm cells).
LOAD CELL CONNECTION	6 wires with Remote Sense.
DISPLAY DIVISIONS	10.000 legal, expandable up to 800.000 for internal use (with signal coming from a cell of at least 1,6mV/V).
DISPLAY	Back lit graphic 160x32 dot LCD
TARE FUNCTION	Subtractive possible on the entire capacity.
MEMORY/DATABASE	Database of 1000 articles and 20 free texts.
INDICATIONS	Graphic icons on LCD display.
KEYBOARD	Impermeable polycarbonate keyboard (IP65 protection degree), with membrane keys having an audible and tactile feedback.
PARAMETER SET-UP	Fully digital calibration and linearization (up to 8 points) programmable from keyboard or from PC with Dinitools™.
TIME/DATE	Fitted, with buffered RAM.
CASE	Anodized aluminium case
SERIAL OUTPUTS	- 2 input/output RS232 ports on terminal board/ amp connector. - 1 input/output RS485 port on terminal board or RS232 on amp connector.
INPUTS AND OUTPUTS	- 8 inputs (optoisolated photo couplers), 12Vdc – 24Vdc, 20mA max. - 16 outputs (optoisolated photomofets), 48Vac / 0.15A, 60Vdc / 0.15A. - Management of the PC keyboard, bar code reader.
ANALOGUE OUTPUT (OPTIONAL)	16 BIT, settable on the net or gross weight on a fixed value for each article (belt speed management); the maximum resistance applicable on the output current is 350 ohm and the minimum resistance applicable on the output voltage is 10 kohm.

2.1 EXTRA ACCESSORIES

The indicator can be implemented with additional internal and external modules used to increase interfacing possibilities. For example, one can increase the number of usable outputs; one may connect various types of printers (in order to have a report of the weighs made) or one can connect a giant display in order to better see the weigh operations. Also, one can connect a PC temporarily in order to simply program the instrument through Dinitools™, or permanently in order to have a complete management of the weighs.

Contact the reseller for the list of the available hardware and software accessories.

2.2 SYMBOLS

Below are shown the symbols used:

- In the manual for recalling the attention of the reader
- On the instrument for recalling the attention of the user



WARNING! This operation must be carried out by specialized personnel



IN CONFORMANCE WITH CE



IDENTIFYING WITH PRECISION CLASS

“TECH.MAN.REF.” IT MEANS THAT AN ADVANCED FUNCTION IS BEING DESCRIBED (THEREFORE FOR THE TECHNICAL PERSONNEL) WHICH WILL BE FURTHER EXPLAINED IN THE CORRESPONDING TECHNICAL MANUAL.

<< XXXXX >> IDENTIFIES THE ABBREVIATION OR THE NAME OF THE STEP OF THE TECHNICAL SET-UP, **TECH.MAN.REF.**

THE INSTRUMENT’S DANGEROUS VOLTAGE PARTS AND THE PARTS THE USER CAN ACCESS HAVE BEEN ELECTRICALLY INSULATED.

3. INSTALLATION

3.1 DRILLING TEMPLATE, CASE AND DIMENSION

The weight indicator has an anodized aluminium case, whose external dimensions are shown in the figure. It should be mounted on a panel board respecting the safety norms.

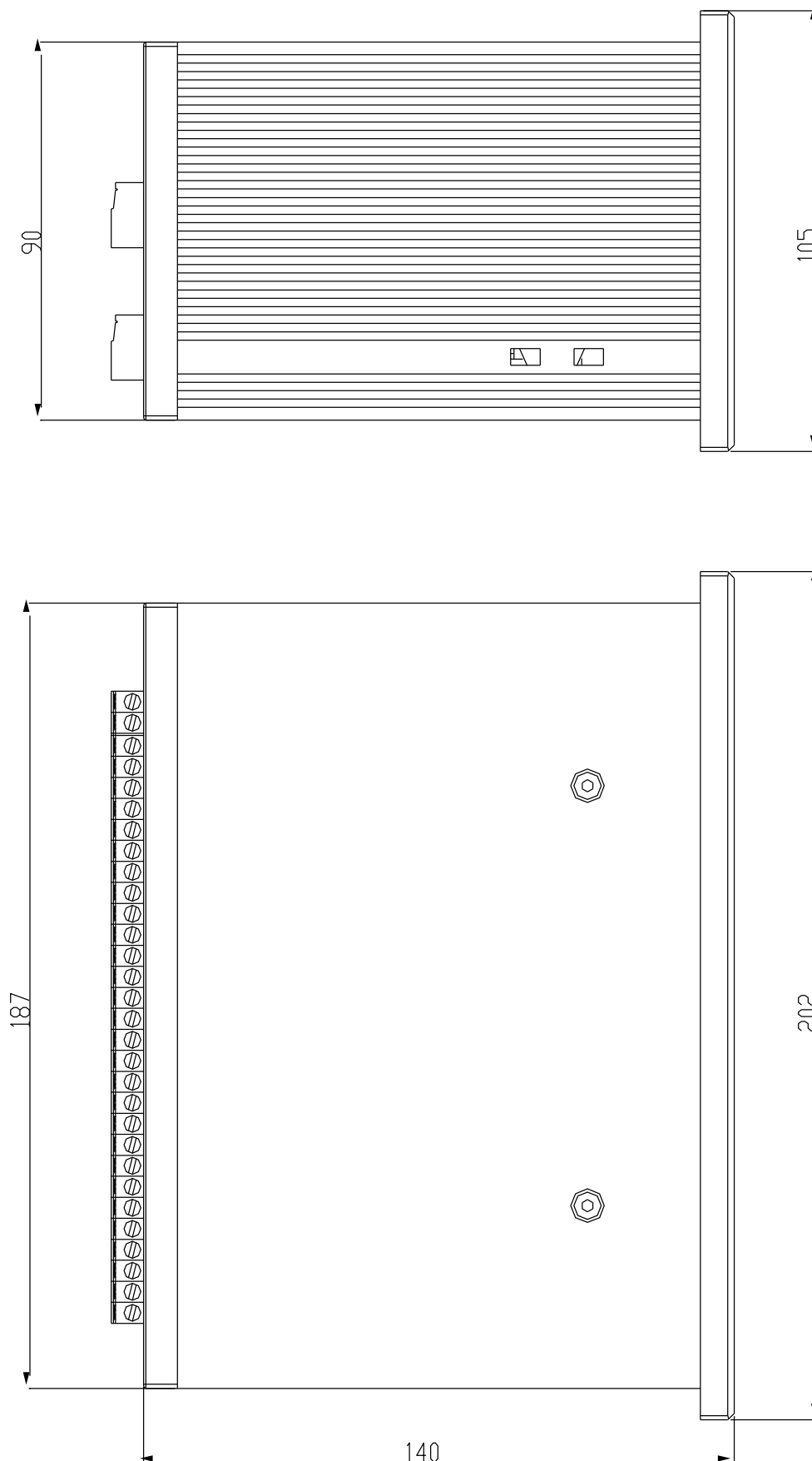

DRILLING TEMPLATE DIMENSION: 187,5mm x 91,5mm

3.2 POWER SUPPLY & START-UP

The indicator is powered with 8÷40 Vdc voltage or a 6 Vdc optional battery. For the connection to the power supply mains the safety norms must be respected including the use of a “clean” line without noise and interference caused by other electronic devices.

NOTE: *It is advisable to completely recharge it (12 hours) in the first installation of the instrument; we RECOMMEND disconnecting the battery if the instrument is not going to be used for more than 30 days.*

Rechargeable battery version: the external optional battery lasts about 15 hours (without expansion board, with a 1-cell platform) and a recharge time of about 12 hours.

BATTERY FEATURES

Material	LEAD
Power	4,5 Ah
Voltage	6 V

THE BATTERY MUST BE SUPPLIED DIRECTLY FROM THE MANUFACTURER.

Do not connect other equipment to the same socket as the one that the adapter is in.

Do not step on or crush the power supply cable

TO TURN ON:

The instrument is automatically turned on as soon as it is powered.

The LCD display shows:

- initially a welcome message (settable in the TECHNICAL SET-UP, << LOGO >> step, TECH.MAN.REF.) while the instrument carries out a series of checking and preheating self tests.
- CHECK - XX name of the installed software, in which XX identifies the software language.
XX.YY is the software version installed.
- “EXECUTION AUTOZERO”; the instrument carries out the “autozero at start-up” function: if a weight is detected within the percentile set in the << Auto 0 >> step (TECH.MAN.REF.), it is cleared; if the weight is not within this tolerance:
 - with a non approved instrument, the display shows the weight after a few instants,
 - with an approved instrument, the message “EXECUTION AUTOZERO” appears continuously on the display, until the weight is within tolerance.

NOTES:

- The autozero function at start-up can be disabled in the set-up environment (only with a non approved instrument), see the <<Auto 0>> parameter.
- If the start-up follows an eventual missing voltage of the indicator with an object to be weighed on the weighing belt, the instrument carries out the auto zero only after the system is restored, as described in section “CYCLE RESTORAL AFTER POWER OUTAGE” .

By pressing the **2ndF** key while the version is shown in the display, the indicator shows in sequence:

XX.YY in which XX indicates the instrument type, YY indicates the metrological software version.

CHECKSUM = XXXX in which XXXX is the checksum of the libraries of the weight management.

XX.YY.ZZ is the installed software version.

HH is the installed hardware version (08).

LEGAL FOR TRADE

or HIGH RESOLUTION if the instrument is APPROVED or UNAPPROVED, respectively.

9.XXXXX is the the g gravity value (only with APPROVED instrument).

TURNING OFF THE INSTRUMENT

Remove the instrument’s power supply.

NOTE: it isn’t possible to put the instrument in standby. By pressing at length the C key, the instrument is restarted.

3.3 CONNECTION TO THE BATTERY POWERED PRINTER

In a system where the indicator is connected to a printer, both are battery powered, the printer is normally maintained in STAND-BY and powered only when a printout is needed. This function reduces the energy absorbed by the battery when the printer is not being used.

If, in this configuration, one should power the printer to change the paper and other maintenance jobs, one needs to keep pressed the **ENTER** and **0** keys (with the weighing cycle disabled, see section "ENABLING / DISABLING THE WEIGHING CYCLE"): the display shows **Prn - on**, and the printer is kept on. Press any key to exit from this condition.

4. FUNCTION PANEL KEYS

In the following section, and later on in the manual, the keys' functioning is described in accordance to how these are configured by factory.

It is possible to customise the functionality of the keys through the << **F.Keys** >> step.

Where it isn't specified, the function is carried out with the weighing cycle disabled (see section "ENABLING / DISABLING THE WEIGHING CYCLE").

KEY	FUNCTION
C / DEL	<ul style="list-style-type: none"> - If pressed for an instant, it clears the tare value. - If pressed at length it restarts the instrument. - Exits the parameter without confirming and saving the modifications. - In the numeric input phase, it quickly clears the present value. - Causes the display of the present metric scale information (see section "DISPLAY OF METRIC DATA (inFO)").
TARE/ ZERO	<ul style="list-style-type: none"> - If pressed for an instant it carries out the semiautomatic tare, or cancels the value of tare if the gross weight is 0. - If pressed at length, it executes the zero functions: <ol style="list-style-type: none"> a) With the weighing cycle disabled, it clears the displayed gross weight, if it's within the percentage configured in the << 0.PErC >> step. b) During the weighing cycle, it enables the auto zero of the belt (see section "WEIGHING BELT AUTOZERO").
Fn / ENTER	<ul style="list-style-type: none"> - In the alphanumeric input phase, it confirms the entry made. - In the menu it allows to enter a step or to confirm a parameter inside a step.
2nd F	<ul style="list-style-type: none"> - If pressed together with the other keys, it allows carrying out a specific function. (see section "'2ndF" KEY: SECOND FUNCTION OF THE KEYS").
. / HELP	<ul style="list-style-type: none"> - In the numeric or alphanumeric input phase, it enters, in this order, the following characters: . , ; : # < > \ " % & / () = ? ^ ' [] { }; - HELP function, see section "HELP MENU".
F1	<ul style="list-style-type: none"> - If pressed for an instant, it enters into the article database. - If pressed at length, it locks and unlocks the instrument's keyboard (except the C key).
F2	<ul style="list-style-type: none"> - If pressed for an instant, it allows to enter the minimum threshold, in the threshold check (see section "TOLERANCE CHECK"). - If pressed at length, the weight visualisation function with sensitivity x 10 is enabled
F3	<ul style="list-style-type: none"> - If pressed for an instant, it allows to enter the maximum threshold, in the threshold check (see section "TOLERANCE CHECK"). - If pressed at length, one can adjust the date and time of the instrument.
F4	<ul style="list-style-type: none"> - If pressed for an instant, it allows to fill in the free texts, if configured - If pressed at length, it enters the instrument's diagnostics menu.
F5	<ul style="list-style-type: none"> - With the weighing cycle disabled, it commands the data transmission to the printer serial port. - If pressed at length, it locks/unlocks the tare.
F6	<ul style="list-style-type: none"> - It allows scrolling ahead inside the menu steps or in the parameters within a step. - In the numeric or alphanumeric phase, it decreases the blinking digit.
F7	<ul style="list-style-type: none"> - It allows scrolling backwards in the menu steps or in the parameters within a step. - In the numeric or alphanumeric input phase, it increments the blinking digit.
F8	<ul style="list-style-type: none"> - If pressed for an instant, it executes the printing and the zeroing of the partial total. - In the numeric or alphanumeric input phase, it selects the digit to be modified from right to left.

F9	<ul style="list-style-type: none"> - If pressed for an instant, it executes the printing and the zeroing of the general total. - In the numeric or alphanumeric input phase, it selects the digit to be modified from left to right.
F10	<ul style="list-style-type: none"> - If pressed for an instant, it executes the printing and the zeroing of the large total. - In the numeric or alphanumeric input phase, introduces a space between two characters.
NUMERIC KEYBOARD	<ul style="list-style-type: none"> - Entry of digits or characters. - While weighing, these enter a numeric value with which it's possible to: <ol style="list-style-type: none"> 1) Set the tare value, by pressing subsequently the TARE key (see section "PRESET TARE"). 2) It executes calculations, and sums or subtractions the result from the current tare (see section "CALCULATOR").

4.1 "2ndF" KEY: SECOND FUNCTION OF THE KEYS

In the weighing phase, by pressing the **2ndF** key together with another key, it's possible to execute various functions (continue reading the manual for the details of the functions):

2ndF	F1	Print/Clearing of Total of each handled Article
2ndF	F3	Prints weighs' report
2ndF	F5	Repetition of the last printout made.
2ndF	F8	Net/Gross Conversion
2ndF	F9	Modification of the data shown on the display with non active weight zoom

4.2 ENTERING ALPHANUMERIC TEXT

It might be necessary, while the weighing system is working, to enter some alphanumerical texts such as descriptions, alphanumerical messages (operator, number of lot, customer, etc.).

To enter the characters one uses the **0** to **9** keys.

By pressing one of these keys a few times, the characters shown on the key will be shown on the LCD display: initially the first letter in the bottom left will appear, and then the other characters towards the right.

After digiting a character, the blinking cursor, after a few instants, advances automatically of a position.

Function of the keys

- F5** switches the writing mode from "numeric" (**nuM**) to "characters" (**ChAr**).
In the **nuM** mode one enters just the numbers, while in the **ChAr** mode one can enter all the characters of a key.
- C** If pressed for an instant, it cancels the written characters: first the characters that follow the cursor are cancelled; than those that precede it, one at a time.
If pressed at length, it deletes all entered characters.
With empty text, it exits the entry phase without confirming.
- SHIFT** It enters a space in the middle of a text.
- ./HELP** If pressed a few times it allows entering the following characters: . , ; : # < > \ | " ' % & / () = ? ^ ' [] { }
- 0** in "characters" mode (**ChAr**), by pressing once **a space is entered**; by pressing twice it enters the "0" character;

- ◀ ▶ moves the blinking cursor to the left or to the right.
- ▲ ▼ scrolls in one sense or the other the list of all the enterable characters (0, 1...9, A, B...Y, Z).

Examples:

- To enter the letter "B" one should press the "2" key twice in the **ChAr** mode.
- To enter the number "3" one should press the "3" key four times (in the **ChAr** mode) or press the F5 key (one passes to the **nuM** mode) and press the "3" key once.

4.3 DISABLING THE KEYBOARD

It is possible to disable the all keyboard functions (except the **C** key for turning on and off), in order to avoid undesired pressings of the scale keys:

- **To lock the keyboard**, press at length the **F1** key: the display shows the "LoCK" message for a few instants. Now the keyboard is LOCKED: if one presses a key, the display shows for a few instants the "PRESS AT LENGTH F1 FOR UNLOCKING" message.
- **To unlock the keyboard**, press again at length, the **F1** key: the display shows the "unLoCk" message for a few instants.

NOTE: It's possible to lock all keys individually in a permanent way through the TECHNICAL SET-UP, **TECH.MAN.REF.**.

4.4 HELP MENU

By pressing at length the **HELP** key it is possible to access a menu containing the list of keys of the instrument and of any configured remote controls, with the relative function, and status (locked or unlocked) indication.



The display shows:

- in the upper part: the key, followed by the code of the linked function in the << **F.Keys** >> step, and a symbol indicating whether the key is unlocked (🔓) or locked (🔒) in the << **EN.KEYS** >> step;
- in the lower part: the description of the linked function.

Scroll the list with the arrow keys ▲ ▼, press the **C** key to exit.

4.5 INDICATOR CONNECTED TO PC KEYBOARD

It's possible to connect a PC keyboard (optional), used to emulate the functions of the keys of the indicator.

The keys are managed in the following way:

Esc	<ul style="list-style-type: none"> - C key. - If pressed at start-up, it allows entering in the technical set-up. - In the alphanumeric input, it deletes all entered characters.
← and Canc	<ul style="list-style-type: none"> -C key. - If pressed at start-up, it allows entering in the technical set-up. - In the alphanumeric input, it cancels first the characters which follow the cursor, then the ones which precede it, one at a time.
Enter	<ul style="list-style-type: none"> - Fn key.

↵	- Confirms the entered value. - Enters the displayed step
Numeric and alphanumeric keys, SHIFT and CAPS LOCK	- Quick entry of a numeric and alphanumeric string: through the CAPS/LOCK or SHIFT key it is possible to switch from the capital letters to the lower case letters, and vice versa, or enter the second character corresponding to the key (for example ", %, &, /, ?).
Cursor keys ↑ ↓	- Scroll the parameters. - Increase or decrease the blinking digit while entering a value.
Cursor keys ← →	- When entering a value or an alphanumeric string, it scrolls the digits to the right or to the left.
F1, F2....F10	F1,F2....F10 keys.
F11	2ndF key.
F12	TARE key.

NOTE: through the remote keyboard, it's not possible to carry out the functions made by pressing the keys at length.

4.5.1 DIRECT COMPILATION OF INPUT TEXT

By entering an alphanumeric text through an external keyboard the instrument goes in alphanumeric clipboard mode; by pressing a function key from F1 to F9 programmed with a direct function to compile an input text (121 up to 130) the edited alphanumeric text is assigned to the corresponding input text. Alphanumeric clipboard contains up to 32 characters.

4.6 REMOTE CONTROL

The remote control allows to remote the functionality of the keys of the instrument. The instrument manages the radio remote control with 6 keys in two modes: remote control to be associated to the instrument and remote control working without any procedure of association.

By pressing on the remote control a key associated to a keyboard key, it's possible to repeat the short pressure and the pressure at length.

4.6.1 RADIO REMOTE CONTROL TO ASSOCIATE

The remote control works only if it is associated to the instrument.

To enable this functioning it's necessary to set "RD 6" in the **SETUP >> inF.rEd** step; then in the steps **KEY 1...KEY 6** it's possible to associate the functions to the keys of the remote control (**TECH.MAN.REF.**).

The procedure to associate the remote control is the follow:

- press the first two keys of the remote control for three seconds;
- press **ENTER** by keyboard when the message is displayed;
- now the remote control is associated to the instrument.

When the remote control is associated, the keys work according to the settings of the steps **KEY 1...KEY 6**.

It's possible to delete the associating of the remote control with the follow procedure:

- press the first two keys of the remote control for three seconds;
- press **C** key by keyboard when the message is displayed;
- now the remote control is not associated to the instrument.

NOTE:

The maximum number of remote controls that can be associated to the instrument is 3. If 3 remote controls have already associated to the instrument and if you want to associate another, the instrument delete the first associating and save the new associating.

4.6.2 RADIO REMOTE CONTROL

The remote control works when the instrument is started. In this mode it's not necessary to associate the remote control to the instrument.

To enable this functioning it's necessary to set "RD.BR 6" in the **SETUP >> inF.rEd** step; then in the steps **KEY 1...KEY 6** it's possible to associate the functions to the keys of the remote control (**TECH.MAN.REF.**).

5. DISPLAY FUNCTIONS

While weighing, the display is subdivided mainly in 3 sections, shown in the figure below:

- 1) WEIGHT
- 2) STATUS INDICATORS
- 3) DATA (one or two lines depending on the weight zoom function; see following section).

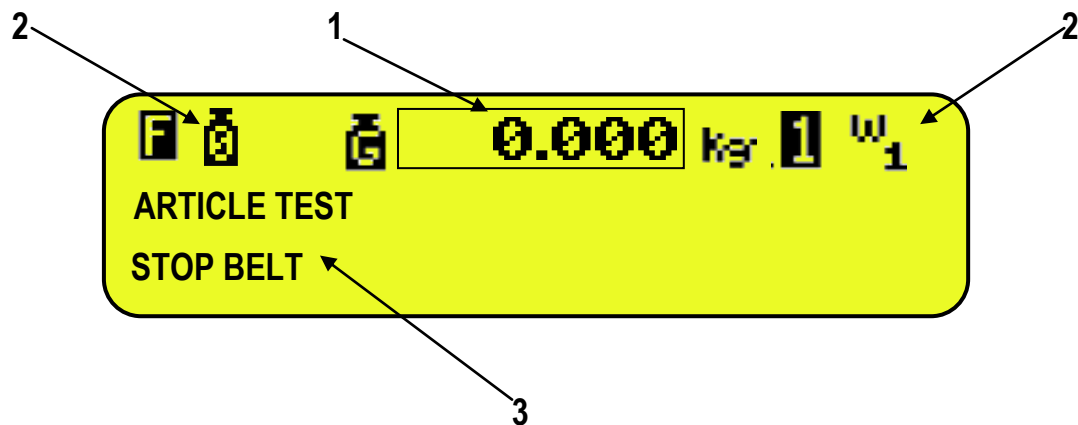

CPWE display

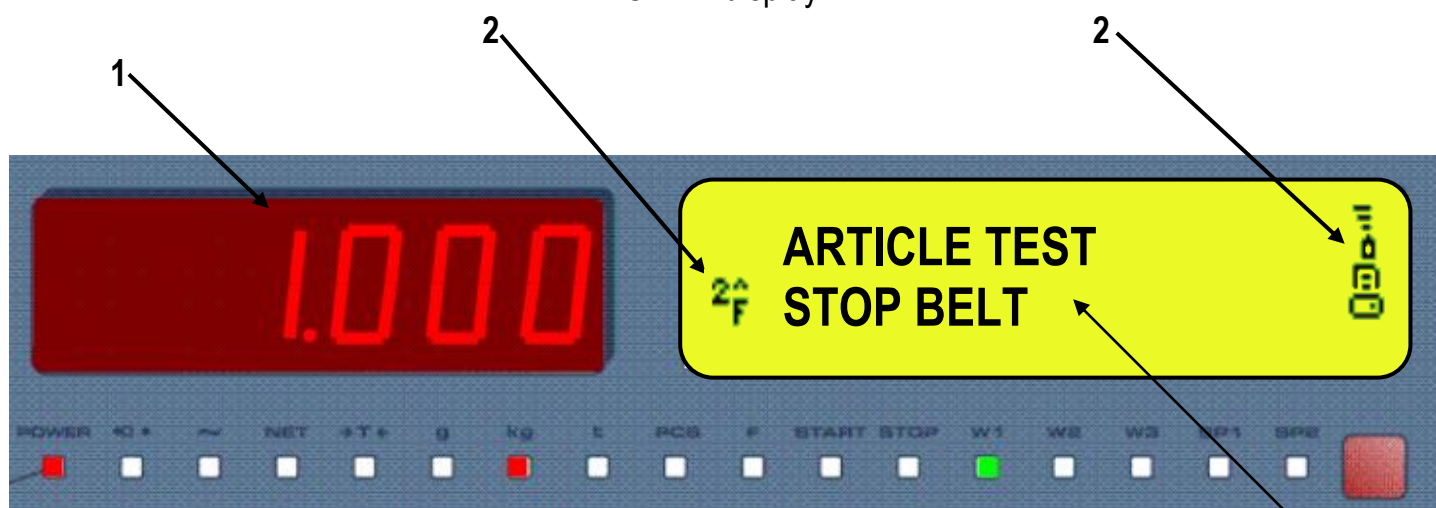

3590E display

5.1 WEIGHT ZOOM

The zoom function allows to increase the size of the weight digits, in order to ease the reading from a distance; with the active zoom, the data is shown on a single line.

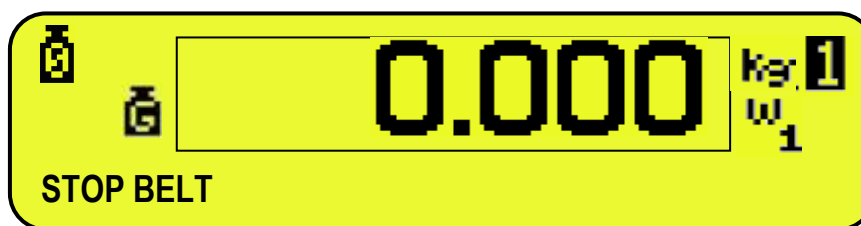

Through the << ZOOM.W >> step, one can disable/enable the function and set a delay which determines the activation mode:

- always active function (with delay equal to 0), or
- disabled function at the pressing of a key and reenabled automatically when the keyboard inactivity time reaches the configured delay period (with delay greater than 0).



5.2 STATUS INDICATORS

SYMBOL ON LCD DISPLAY	FUNCTION
	The weight detected by the weighing system is near the zero, included within the interval of $-1/4$ and $+1/4$ of the scale division.
	The weight is unstable.
	The displayed weight is a GROSS WEIGHT (depending on the software language).
	The displayed weight is a NET WEIGHT.
	A tare value has been acquired.
	A manual tare value has been entered.
	Unit of measure in use: ton, kilogram, gram, pounds, millilitres, or millivolts.
	Active weighing range, see section "MULTIRANGE FUNCTION".
	Active scale (always 1).
	Indicates that a specific function of the instrument is active.
	Battery charge level: see section "BATTERY LEVEL INDICATION".
	Active during the configuration of the date and time.
	Locked keyboard, see section "DISABLING THE KEYBOARD".
	In the HELP menu these respectively indicate whether a key is unlocked or locked in the SETUP level (<< En.KEYS >> step, see section "HELP MENU").
	The Fn key has been pressed.
	The 2nd F key has been pressed.
	Transmission of the data to the printer serial port under way.
	Inside the step, these respectively indicate an unselected or selected parameter.
	Active calculator function, see section "CALCULATOR".





5.2.1 BATTERY LEVEL INDICATION

The indicator is able to recognise whether it is powered by mains or by battery, and indicate its charge level; to enable the battery level indication, one should configure the << Bt.Stat. >> step.

The charge level is shown during weighing by the battery symbol.

- : charged battery.
- : partially charged battery.
- : discharged battery: connect the indicator to the mains for recharging the battery (if provided for by that model) or replacing the battery. Furthermore, the "Low.bat " message will appear for a few seconds on the display (voltage at minimum level).

The indicator shows also when the battery is being recharged (if provided for the model):

RECHARGE PHASE:  →  →  →  →  ...

COMPLETED RECHARGE: 

NOTES:

- During the recharge the instrument can be normally used.
- The instrument automatically turns off when the voltage goes below the minimum level.

5.3 MODIFICATION OF THE DISPLAYED DATA

The data shown on the display can be modified by selecting one of the various visualisations provided for by the indicator.

CPWE

The selection of the visualisation with non active weight zoom, and the one with active zoom (see section "WEIGHT ZOOM") are independent from each other.

SELECTION OF VISUALISATION WITH NON ACTIVE WEIGHT ZOOM

The data is shown on two lines; by pressing in sequence the **2nd F** and **F9** keys (associated with the function 107), with the weighing cycle disabled (see section "ENABLING / DISABLING THE WEIGHING CYCLE"), one scrolls in order the following visualisations:

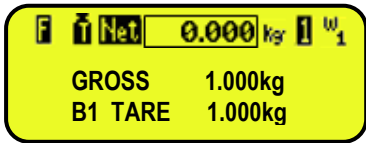
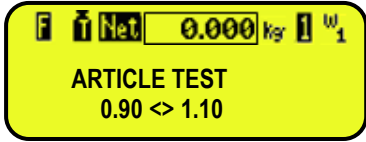
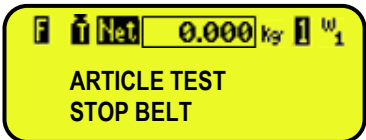
NUMBER	VISUALISATION	EXAMPLE
0	<ul style="list-style-type: none"> - Gross or net weight on the scale - Active semiautomatic tare (PT if manual tare) 	
1	<ul style="list-style-type: none"> - First article description or net weight - Tolerance range (see section "TOLERANCE CHECK"). 	
	<p>NOTES:</p> <ul style="list-style-type: none"> - the ranges are shown in the database unit of measure (or in ml if a density different than 1.0000 has been entered) - if the range is not valid, the "NO RANGE" message will be displayed - this visualisation is available only with the tolerance test enabled, in the check types with article, it is possible only with the article selected. 	
2	<ul style="list-style-type: none"> - First article or net weight description - System status (see section "SYSTEM STATUS VISUALISATION"). 	

3	<ul style="list-style-type: none"> - Lot weighs total - Accumulated lot total 	
---	---	--

By linking the function to a direct key, see the << **F.Keys** >> step, it is possible to quickly recall a visualisation by digiting, with the numeric keyboard, the relative number and pressing the key linked to the function.

Furthermore, by linking the number of a specific visualization to the function (preamble function in the << **F.KEYS** >> step), it is possible to select it directly with a direct key, for example F1 key to select the visualization n.1, and F2 key to select the visualization n. 2.

Notes:

- Visualisation of default 1.
- If in visualisation 1 in the place of the threshold values there are EEEEE, this means that the values of the selected article weight are not correct.
- If in visualisation 3 in the place of the lot total, the EEEEE message appears, this means that the value exceeds the maximum number of digits shown by the instrument.

VISUALISATION SELECTION WITH ACTIVE WEIGHT ZOOM

The data is shown on one single line; through function 208, linkable to the desired key (<< **F.Keys** >> step, **TECH.MAN.REF.**), with the weighing cycle disabled (see section “ENABLING / DISABLING THE WEIGHING CYCLE”) it is possible to scroll in this order the following visualisations:

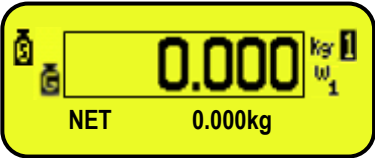
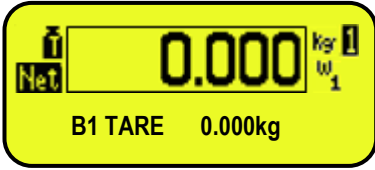
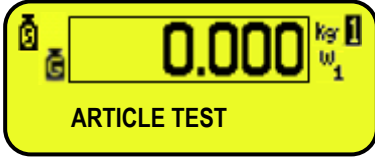
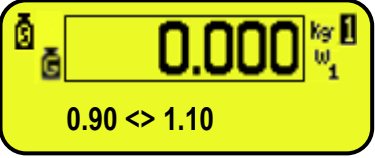
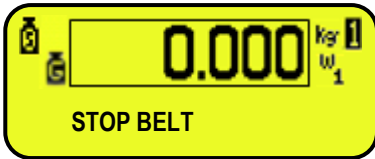
NUMBER	VISUALISATION	EXAMPLE
0	Gross or net weight on the scale	
1	Active semiautomatic tare (PT if manual tare)	
2	First article description	
<p>NOTE: this visualisation is available with the selected article.</p>		
3	Tolerance ranges (available with the tolerance test enabled, see section “TOLERANCE CHECK”).	
<p>NOTES:</p> <ul style="list-style-type: none"> - the ranges are shown in the database unit of measure (or in ml if a density different than 1.0000 has been inserted) - if the range is not valid, the “NO RANGE” message will be displayed. - this visualisation is available only with the tolerance test enabled, In the check types with article, it is possible only with the article selected. 		
4	System status (see section “SYSTEM STATUS VISUALISATION”).	

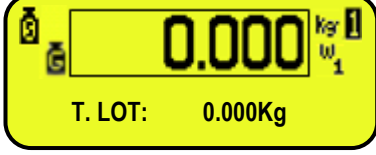
5	Lot weighs' total.	
6	Accumulated lot total.	

By linking the function to a single key, it is possible to quickly recall a visualisation, by digiting from the numeric keyboard, the relative number, and by pressing the key linked to the function.



Furthermore, by linking the number of a specific visualization to the function (preamble function in the << F.KEYS >> step), it is possible to select it directly with a direct key, for example F1 key to select the visualization n.1, and F2 key to select the visualization n. 2.

NOTES:

- Default visualisation: 1
- If in visualisation 3, in the place of the threshold values, there are EEEEE, this means that the values of the selected article weight are not correct.
- If in visualisation 6, in the place of the lot total, there is the message EEEEE, this means that the value exceeds the maximum number of displayable digits by the instrument.

3590E

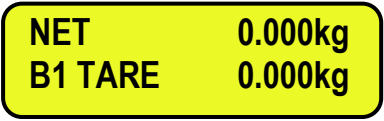
The selectable info are shown in the LCD display; by pressing in sequence the 2nd F and F9 keys, one scrolls in order the following visualisations:

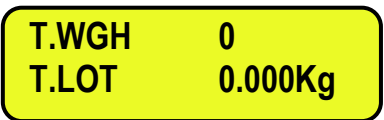
NUMBER	VISUALISATION	EXAMPLE
0	<ul style="list-style-type: none"> - Gross or net weight on the scale - Active semiautomatic tare (PT if manual tare) 	
1	<ul style="list-style-type: none"> - First article description or net weight - Tolerance range (see section "TOLERANCE CHECK"). 	
	<p>NOTES:</p> <ul style="list-style-type: none"> - the ranges are shown in the database unit of measure (or in ml if a density different than 1.0000 has been entered) - if the range is not valid, the "NO RANGE" message will be displayed - this visualisation is available only with the tolerance test enabled, in the check types with article, it is possible only with the article selected. 	
2	<ul style="list-style-type: none"> - First article or net weight description - System status (see section "SYSTEM STATUS VISUALISATION"). 	
3	<ul style="list-style-type: none"> - Lot weighs total - Accumulated lot total 	

By linking the function to a direct key, see the << F.Keys >> step, it is possible to quickly recall a visualisation by digiting, with the numeric keyboard, the relative number and pressing the key linked to the function.

Furthermore, by linking the number of a specific visualization to the function (preamble function in the << F.KEYS >> step), it is possible to select it directly with a direct key, for example F1 key to select the visualization n.1, and F2 key to select the visualization n. 2.

Notes:

- Visualisation of default 1.
- If in visualisation 1 in the place of the threshold values there are EEEEE, this means that the values of the selected article weight are not correct.
- If in visualisation 3 in the place of the lot total, the EEEEE message appears, this means that the value exceeds the maximum number of digits shown by the instrument.

CUSTOMIZED VISUALISATION

Through function **120** combinable with the desired key (<< **F.KEYS** >> step, **TECH.MAN.REF.**), one enables the custom display function. The display shows:

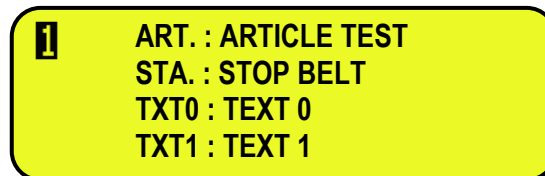

In which:

- "ART." indicates article description.
- "STA." indicates system status.
- "TXT0" indicates the contents of the input text 0.
- "TXT1" indicates the contents of the input text 1.

Each row contains up to 22 characters.

By pressing **Fn + F9** it's possible to directly enable the function; by pressing **2ndF + F9** it's possible to change the visualizations on the LCD display to disable the function.

NOTE: The function is only for 3590E indicator.

5.3.1 SYSTEM STATUS VISUALISATION

Below there are the statuses shown on the display, in the visualisation of the SYSTEM STATUS.

In order to select this visualisation, refer to the previous section.

STATUS	DESCRIPTION
MOTOR ALARM	Locked weighing cycle: the EMERGENCY / MOTOR LOCK input (IN.6) is active for a minimum time set in step << BLK.MOT >>; the cycle restarts as soon as the input has been disabled.
WEIGHT ALARM	Locked weighing cycle: the instrument has detected a weight greater than the Maximum capacity + 9d or less than -100d, for a minimum time period configured in step << W.UN.OV >> (only with a time period greater than 0), One should restore the weight and supply an impulse on the RESTART input (IN.4) in order to reenale the cycle.
WAITING	The instrument is ready for weighing, and waits for the obscuring of the pack presence photo cell (IN 2) (functioning with photo cell), or for a weight greater than the minimum weigh threshold (functioning without photo cell).
RESTART WAIT	One should supply an impulse on the RESTART input (IN.4) in order to reenale the cycle after an error condition.
START WAIT	One should supply an impulse on the RESTART input (IN.4) in order to enable the cycle with the belts stopped at start-up.
IN WEIGHING	The instrument is acquiring the weight of the object.
PACK EVACUATION	The instrument has carried out the various cycle phases and proceeds with the evacuation of the weighed object.
OUT OF TOLERANCE	During the compulsory weight correction, a restart impulse has been given with the weight out of tolerance (see section "CORRECTION OF THE OUT OF TOLERANCE WEIGHT").
NON WEIGHED PACK	The object to be weighed on the weighing belt has not been weighed because the consensus from downstream has been disabled (IN.1) or the input voltage of the indicator has gone missing during the weigh acquisition. One should supply an impulse on the RESTART input (IN.2) in order to reenale the cycle.
WEIGHED PACK	The object to be weighed on the weighing belt has been weighed before disabling the consense from downstream (IN.1) or from a missing input voltage of the indicator. One should supply an impulse on the RESTART input (IN.4) in order to reenale the cycle.
POSITIONING	After the pack presence photo cell is obscured (IN 2), the instrument waits of the pack positioning time before acquiring the weigh.
STOP BELT	Disabled weighing cycle (see section "ENABLING / DISABLING THE WEIGHING CYCLE"), in the simple weighing condition, with the stopped belts.
WEIG.TIME LAPSED	During the weigh acquisition, the weigh has been unstable for a time period greater than the value set in step << T.M.PES >> (only if the weighing at halt has been selected). One should supply an impulse on the RESTART input (IN.4) in order to reenale the cycle.

5.4 MESSAGES

While using the indicator, it is possible to incur into the following errors:

INSIDE THE SET-UP OR MENU

MESSAGE	DESCRIPTION
C.Er. – 8.03	When carrying out the multirange or multidivisional calibration, the ranges have not been entered in an increasing manner (RANGE 1 < RANGE 2 < RANGE 3).
C.Er. – 36	During the calibration some internal negative points have been calculated: <ul style="list-style-type: none"> - the calibration point is less than the zero point. - the signal is negative (check the connections)
C.Er. – 37	During the calibration some internal points less than the minimum value have been calculated: <ul style="list-style-type: none"> - the calibration point is equal to the zero point. - A capacity too high in relation to the division has been set.
ERROR: UNSTABLE WEIGHT	The weight results to be unstable and therefore can not be acquired; press ENTER to display the menu of the next possible operations or C to exit from the step.
ErPnt	During the acquisition of a calibration point, a null value from the converter has been read.
SAVE AND EXIT?	The instrument requests the saving when exiting the set-up; press ENTER to confirm or C to not continue.
SURE?	The instrument requests a confirmation before proceeding: press ENTER to confirm or C to not continue.

AT START-UP

MESSAGE	DESCRIPTION
Err – 36 No Cal.	The points of the converter are negative: <ul style="list-style-type: none"> - the calibration point is less than the zero point. - the signal is negative (check the connections). One must execute a TECHNICAL DEFAULT (DfLt.t parameter of the SET-UP environment) and carefully carry out the calibration
Er – 37 alternately with No.Cal	The converter points are less than the instrument's internal divisions; one must execute a TECHNICAL DEFAULT (DfLt.t parameter of the SET-UP environment) and carefully carry out the calibration.
Er – 39	Invalid calibration range number (there is the value 0 or values greater than 3); one must execute a TECHNICAL DEFAULT (DfLt.t parameter of the SET-UP environment), if not already executed previously, and carefully carry out the calibration.
Er – 40	The value 0 is in the "range 1" parameter of the calibration; one must execute a TECHNICAL DEFAULT (DfLt.t parameter of the SET-UP environment) and carefully carry out the calibration.
Er – 41	The value 0 is in the "div 1" parameter of the calibration; one must execute a TECHNICAL DEFAULT (DfLt.t parameter of the SET-UP environment) and carefully carry out the calibration.
hW-Err	HARDWARE ERROR: software not compatible with the installed hardware; the hardware expansion component is missing which allows the software to function.
EXECUTION AUTOZERO	"autozero at start-up" function is active (see section "POWER SUPPLY & START-UP").

NOTE: if the Er – XX error appears after the indicator start-up; press the TARE key to enter in the SET-UP environment.

IN WEIGHING

MESSAGE		DESCRIPTION
WITH ZOOM NOT ACTIVE	WITH ZOOM ACTIVE	
ARTICLE NOT SELECTED	ART.NOT SELECTED	If the tolerance check has been enabled, one should select an article in order to start the weighing cycle. This message indicates that no article has been selected
EXECUTION AUTOZERO	EXECUTION AUTOZERO	"Autozero at start-up" belt function (see section "WEIGHING BELT AUTOZERO").
STOP FOR WEIGH ERRORS	ERRORS WEIGH	The number of weighs executed out of tolerance has reached the set value (see section "AUTOMATIC TARGET RECALCULATION AFTER N WEIGHS WITHIN TOLERANCE").
OUT OF TOLERANCE		During the compulsory weight correction, the restart impulse has been supplied with the weight out of tolerance (see section "CORRECTION OF THE OUT OF TOLERANCE WEIGHT").
NON VALID OR UNSTABLE WEIGHT		Printing not possible with weight at 0, negative, unstable.
NO ZERO CROSS OR INSTABILITY		Printing not possible without having the weight pass by the net zero or by instability.
*** POWER OFF ***		Turning off of the instrument through the key (see section "POWER SUPPLY & START-UP").
RESET LOT?		Request of lot total clearing (see section "VISUALISATION AND CLEARING OF THE ACCUMULATED TOTALS")
INVALID TOLERANCE THRESHOLDS	INVALID THRESHOLDS	If the tolerance check has been enabled, one should set the valid thresholds. This message indicates that a minimum threshold exceeding a maximum threshold, has been inserted.
TOLERANCE CHECK DISABLED		One is trying to select an article, but the tolerance test has not been enabled.

IN THE WEIGHING IN THE WEIGHT SECTION

MESSAGE	DESCRIPTION
.....	Under weigh -100d (with approved instrument) or over the Maximum Capacity + 9d .
ZERO	Execution of scale zero (see section "SCALE ZERO FUNCTION").
TARE	Tare execution (see section "TARE FUNCTIONS").
CLEAR	Tare cancellation (see section "TARE FUNCTIONS").
prn-on	Turning on printer for maintenance (see section "CONNECTION TO THE BATTERY POWERED PRINTER").
GROSS	Visualisation of the gross weight.
NET	Visualisation of the net weight.
LOCK	Tare lock or enabled keyboard function.
UNLOCK	Tare lock or disabled keyboard function.

6. SCALE ZERO FUNCTION

With the weighing cycle disabled (see section "ENABLING / DISABLING THE WEIGHING CYCLE"), keep the **ZERO** key pressed at length; the message "ZERO" appears on the LED display after which:

- If the weight on the scale is included in the percentage configured in the << **0.PErC** >> step (**TECH.MAN.RIF.**), it is zeroed;
- If the weight is not within this range, it will not be cleared and an error sound is emitted.

In the end the indicator automatically returns to the display of the weight present on the scale.

It's possible to execute the zero also with weighing cycle enabled, by using the function of "WEIGHING BELT AUTOZERO" (see the section "WEIGHING BELT AUTOZERO").

7. TARE FUNCTIONS

7.1 SEMIAUTOMATIC TARE

To tare any weight which is on the scale one should:

- remove the consensus from downstream (IN 1 = 0Vdc), if not excluded in the << **diS.d.st** >> step;
- press the **TARE** key.

The display shows "**tArE**" for an instant and then 0 (net weight); furthermore also the relative indicators are enabled.

The display shows therefore the gross weight value and the stored tare value.

In any case, a new operation automatically cancels and substitutes the previous one.

NOTE: The semiautomatic tare is acquired only if the weight is of AT LEAST ONE DIVISION AND IS STABLE (indicator ~ instability led is off) and VALID (In other words the UNDERLOAD and OVERLOAD conditions must not be created).

7.2 PRESET TARE

To enter the tare value, one should:

- remove the consensus from downstream (IN 1 = 0Vdc), if not excluded in the << **diS.d.st** >> step;
- with the keyboard, type the value (including the decimal point) and press **TARE**.

The indicator automatically subtracts the entered value from the displayed weight, (the relative indicators are enabled), as long as it is not greater than the instrument's maximum capacity.

The display shows therefore the gross weight value and the stored tare value, identified with "PT" (Preset Tare).

The operation can be made either with a loaded or unloaded platform.

In any case, when a new Tare value is entered, the preceding one is cancelled and substituted.

NOTE: In the printout, the manual tare is identified with "PT" (Preset Tare).

7.3 CALCULATED MANUAL TARE

With the "CALCULATOR" function one can add or subtract from the current tare the result of an operation between two values entered with the keyboard.

For the functioning specifics see the "CALCULATOR" section.

7.4 TARE CANCELLATION

To cancel the stored tare:

- With an **unloaded** platform, press the **TARE** key.
- With loaded platform press in sequence the numeric 0 key and **TARE**.
- Press the **C** key (**CAREFUL:** this operation cancels also the executed reference).

7.5 LOCKED/UNLOCKED TARE

Normally, when a tare value has been entered (automatically, manually or from storage) by unloading the scale plate, the display shows the tare value with a negative sign (LOCKED TARE). One can also choose that the tare value is cancelled automatically, each time that the scale is unloaded (UNLOCKED TARE).

CONDITIONS FOR AUTOMATIC UNLOCKING:

- In case of SEMIAUTOMATIC TARE, the net weight before unloading the scale may also be 0.
- In case of MANUAL OR CALCULATED TARE or FROM DATABASE, the net weight before unloading the scale must be of at least 2 stable divisions.

If the **F5** key is pressed at length, it is possible to quickly lock/unlock the tare:

DISPLAY	MEANING
LoCK	LOCKED TARE
UnloCk	UNLOCKED TARE

It is possible to carry out this setting or disable completely the tare operations through the **<< t.LoCk >>** "LOCKED/UNLOCKED TARE" parameter of the SET-UP environment.

7.6 LIMITATION OF THE TARE FUNCTIONS

For specific requirements, it is possible to limit the functions of the tare **with approved instrument**; by setting "YES" in the **<< D.SALE >>** step.

- the SEMIAUTOMATIC TARE can not be modified with a manual or calculated tare, or one from database.
- the manual or calculated tare, or one from database must be entered or modified only with UNLOADED scale.

With approved instrument, the **<< D.SALE >>** step is read only.

7.7 LINKING A KNOWN TARE VALUE TO AN ARTICLE

It is possible to link a known tare value to each article in the database; this value will be enabled with each selection of the article.

See section "ENTRY" for further details.

8. MULTIRANGE FUNCTION

The **multi range functioning** allows to subdivide the scale capacity in two or three ranges, each which is up to 3000 divisions, improving in this way the first range division in the dual range and the first two ranges in the triple range.

For example it is possible to approve the weighing system with:

- A single range: 6 kg capacity and 2 g division (3000 div.).
- Dual range: 6 / 3 kg capacity and 2 / 1 g division (3000 + 3000 div.).
- Triple range: 15 / 6 / 3 kg capacity and 5 / 2 / 1 g division (3000 + 3000 + 3000 div.).

NOTE: For the approval of the weighing system in dual and triple ranges the cell must have better technical features in comparison to the cell used for the approval in a single range.

This functioning is indicated by the enabling of the symbol which identifies the range in which one is working: **W1** first range, **W2** second range, **W3** third range (if configured); by passing to the **W2** range, the second range division is enabled; by passing to the **W3** range, the third range division is enabled, at this point the **W1** first scale division is restored **only by passing the gross zero of the scale**.

The **multidivisional functioning** is similar to multirange, but with the difference that a range division is enabled as soon as one enters in its range interval (in other words **without passing by the scale zero**).

NOTE: The selection of the range number with multirange and multidivisional functioning is made during the indicator calibration (**TECH.MAN.REF.**).

9. DISPLAY OF METRIC DATA (inFO)

The indicator is fitted with a function named "INFO", thanks to which it is possible to view the configuration metric data:

- First range capacity, first range minimum weigh, first range division.
- Second range capacity, second range minimum weigh, second range division.
- Third range capacity, third range minimum weigh, third range division.

NOTES:

- The minimum weigh corresponds to 20 net weight divisions.
- The data of the second and third range appear only if actually configured.

To display the metric data:

By pressing **2ndF + C** the display will show "METROLOGIC INFORMATION".

- The display will show the number of the scale, the type of displayed data ("MAX" for the capacity, "MIN" for the minimum weigh, "e" for the division) and its value.
- Press the **F6** key to quickly scroll the following data in this order:
Capacity 1° range ⇒ Minimum weigh 1° range ⇒ Division 1° range ⇒ Capacity 2° range ⇒.....
- Press the **F7** key to scroll the previous data backwards.
- Press the **ENTER** key to view the metric data of the following range.
- Press the **C** key to return to weighing.

10. FILLING IN THE INPUT TEXT

The indicator offers the possibility of using 15 CONFIGURABLE INPUT TEXTS (for example LOT, OPERATOR, SHIFT, etc.) in the **F.ModE** → **tXt** step (**TECH.MAN.REF.**), each contains the following steps:

- **DESCRIPTION** the heading of the input text, up to 16 characters.
- **TEXT** the contents of the input text, up to 32 content characters.
- **THRESHOLD** the length limit of the contents of the input text, from 1 to 32.
- **MANDATORY INPUT** force to insert contents of the input text.
If the function is enabled, in the weighing phase, by pressing **F4** key to modify the contents of the programmed input texts, only when the contents is not null, exit from alphanumeric input by pressing **C** key.
- **ONLY VOID INPUT** only access to the input text in which the contents is null.
If the function is enabled, in the weighing phase, by pressing **F4** key only to modify the programmed input texts in which the content is null.

When entered in the TECHNICAL SET-UP (see << **tXt** >>, **TECH.MAN.REF.**), these may be printed later on, if programmed in the printouts; or these may be used as a reminder.

In the weighing phase:

- 1) Press **F4** for an instant one can enter the contents of the programmed INPUT TEXTS:
- 2) The display shows "in. XX" on the first line, in which XX is the index of the input text (from 0 to 14) THE HEADING on the second line of the input text (or "Empty..." if empty).
- 3) Use the arrow **▲ ▼** keys to select the text to be filled in and press **ENTER**: now one can enter the alphanumeric text in the second line of the LCD display (see chapter "ENTERING ALPHANUMERIC TEXT").
NOTE: The length of the enterable characters depend on the value set in the "THRESHOLD" step.
- 4) Press **ENTER** to store and pass on to the following stored TEXT; by confirming the last entered text one returns automatically to the weigh functioning;
- 5) it is possible to exit also with the **C** key while in the text selection modification phase.

NOTE:

- The entered texts remain in storage until these are substituted or cancelled.
- If no text has been configured, the pressing of the **F4** key has no effect.

COPY OF THE TEXT

After inserting an alphanumeric text, by pressing the **F1** key, it will be possible to copy the contents and make these available when making a new insertion through the pressing of the **F2** key.

QUICK MODIFICATION OF AN INPUT TEXT

- By linking the number of a specific input text to the function **113** (preamble function in the << **F.KEYS** >> step, **TECH.MAN.REF.**), it is possible to access directly to the modification of it with a direct key, for example **F1** key to quickly access the text 0, and **F2** key to quickly access the text 1.
- Through function **121** to **130** combinable with the desired key (<< **F.KEYS** >> step, **TECH.MAN.REF.**), it's possible quickly to modify the contents in the input text 0 to 9.
For example, if the **F1** key is associated with function 121, inserting a string of the characters from the external keyboard, and then pressing the **F1** key, the string of the characters will be automatically stored in the input text 0 and replace original characters.

QUICK CANCELLATION OF THE CONTENTS OF AN INPUT TEXT OR ALL THE INPUT TEXTS

Through function **131** combinable with the desired key (<< **F.KEYS** >> step, **TECH.MAN.REF.**), it's possible quickly to cancel the contents of the input text.

The function **131** is enabled, one is asked to insert the input text number to be cancel, if the number is inserted at 99, it will cancel the contents of all the input texts.

NOTE: Only the contents of the input text is cancelled.

11. ARTICLES DATABASE

The indicator has a database in which it is possible to store up to 1000 articles having three descriptions of 20 characters; each article is linked to a storage number, from 0 to 999.

The selected article is shown on the display during the weighing operations, and can be printed through the relative print block.

To access to the functions described below for the management of the database, one has to disable the weighing cycle (see the section "ENABLING / DISABLING THE WEIGHING CYCLE").

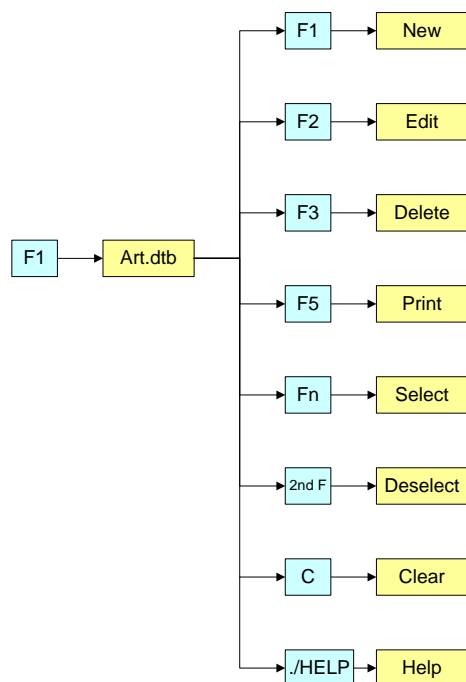

11.1 ENTRY

- 1) Press the **F1** key to enter in the article database.
- 2) Select the eventual desired position using the arrow keys \blacktriangle \blacktriangledown (or with the keyboard type the position number).
- 3) Press **F1** to insert the article in the desired position, or with the first free position, if an already occupied position has been selected.
- 4) One should fill in the following fields (only the necessary ones are requested); press **ENTER** to confirm:
 - "**DESCRIPTION 1**": first description line (up to 20 characters);
 - "**DESCRIPTION 2**": second description line (up to 20 characters);
 - "**DESCRIPTION 3**": third description line (up to 20 characters);
 - "**ENTER DENSITY**": here one can enter the value, expressed in g/ml;
 - "**TARGET**": put the target weight on the scale and press ENTER. In any case it is possible to manually enter the target value, by pressing the C key when the instrument shows "AUTO TARGET" on the LCD display. The instrument is ready for the manual entry of the target; once the value is entered, confirm with **ENTER**; in case of density different than 1, the entered value is expressed in ml;
 - "**T1 THRESHOLD**": first tolerance value (for the type of check with article and tolerances, see section "CHECKING WITH ARTICLE AND T1,T2,T3 TOLERANCE SETTING")
 - "**T2 THRESHOLD**": second tolerance value (for the type of check with article and tolerances, see section "CHECKING WITH ARTICLE AND T1,T2,T3 TOLERANCE SETTING")
 - "**T3 THRESHOLD**": third tolerance value (for the type of check with article and tolerances, see section "CHECKING WITH ARTICLE AND T1,T2,T3 TOLERANCE SETTING")
 - "**MINIMUM THRESHOLD**": minimum threshold value (for the type of check with article and tolerances, see section "CHECKING WITH ARTICLE AND MINIMUM AND MAXIMUM THRESHOLD SETTING")
 - "**MAXIMUM THRESHOLD**": maximum threshold value (for the type of check with article and tolerances, see section "CHECKING WITH ARTICLE AND MINIMUM AND MAXIMUM THRESHOLD SETTING")
 - "**PRESET TARE**": value of the known tare, relative to the article.
 - "**EXP.DEL.TIME**": enabling delay time of the expeller for which the instrument will wait only for this article.

In fact, if one sets the "Enable" parameter << **Rit.Esp.** >> step (**TECH.MAN.REF.**), the instrument will adopt the expeller delay time of the selected article.

- "**ANALOGUE OUTPUT**": value which the analogue output takes on for this article, useful for adjusting the belt speed depending on the selected article (see section "ANALOGUE OUTPUT (OPTIONAL)", **TECH.MAN.REF.**); one enters the values of the digital / analogue converter (between 0 and 65535) to which a certain voltage or current output value corresponds. The instrument keys take on the following functions:

ENTER By pressing it once after entering a value, it activates the corresponding analogue output value, (allowing its control) but remains still inside the step in case of a new modification. By pressing it a second time (on the same entered value), confirms and exits the compilation of the article.

C Allows to quickly clear the current value.

NUMERIC KEYS Allow to enter the values, from right to left.

If a digit greater than 65535 is entered, the instrument clears the entered value.

11.2 MODIFICATION

- 1) Press the **F1** key to enter in the article database.
- 2) Select the storage to be modified by using the arrow keys ▲ ▼ (or with the keyboard type the storage number; the LCD display shows the first corresponding DESCRIPTION line) and press **F2**.
- 3) Modify the desired fields, listed in the previous section.
- 4) Press the **C** key to return to weighing.

11.3 CANCELLATION

- 1) Press the **F1** key to enter in the article database.
- 2) Select the storage to be cancelled by using the arrow keys ▲ ▼ (or with the keyboard type the storage number; the LCD display shows the first corresponding DESCRIPTION line) and press **F3**.
- 3) The indicator requests a further confirmation: press **ENTER** to confirm or another key to cancel.
- 4) Press the **C** key to return to weighing.

11.4 PRINTING

- 1) Press the **F1** key to enter in the article database.
- 2) Once inside the article database menu, press the **F5** key. The LCD display shows the message "**PRINT?**": confirm with the **ENTER** key to print the entire article database which shows all the relative fields for each stored article.

11.5 SELECTION/UNSELECTION

To select a stored article, one can proceed in two ways:

- 1) Enter the article storage number using the numeric keyboard (if different than the 000 storage, see the following section) and press **F1**: if an article is stored in the recalled position, the indicator display shows the message "ARTICLE XXX SELECTED" (in which XXX indicates the number of the selected storage) and activates it.
- 2) Press for an instant the **F1** key to enter in the article database:
 - Select the storage using the arrow keys ▲ ▼ (or with the keyboard type the storage number; the LCD display shows the first corresponding DESCRIPTION line).
 - Press **ENTER** to activate the article.

To unselect a selected article, for an instant press the **F1** key to enter in the article database and press **2nd F**.

Before unselecting, a confirmation is requested: press **ENTER** to confirm or another key to cancel.

11.6 ENTRY, MODIFICATION AND QUICK SELECTION OF ARTICLE 000

It's possible to enter or modify quickly the article 000:

- Type the number 0 using the numeric keyboard and press **F1**:
- The indicator is ready to enter/modify the article 000: once modified and confirmed with **ENTER**, it is also selected. **The modification has effect also in the database.**

11.7 HELP

By pressing the **/HELP** key, it's possible to see the keys list used in the menu.

The key list is automatically. If you want to see the keys list, in manual mode, use the arrow key (F6 ▼ and F7 ▲).

12. DATABASE ACCESS PASSWORD

In the SETUP (<< **dtb.PWD** >> parameter) one can set a password for access to the databases. A password will be required only when one wants to insert, modify or delete an element of the file; for a moment the display shows the message USER-PRESS KEY; afterwards, it will be no longer possible to make changes to the database.

To access the complete menu

- Press any key DURING THE VISUALISATION OF THE “USER-PRESS KEY”: the instrument requests the entry of the password (a number will appear).
- Enter the password and confirm with ENTER.

13. WEIGHING PROCEDURES

The programme has been made to manage an automatic weighing cycle on belt, either static or dynamic, with tolerance control, accumulation, and printing of the executed weighs.

The input/output allows for the automatic belt management for the handling, weighing, and selection or expulsion.

To start the automatic weighing operations, one should enable the weighing cycle as described in the following sections.

13.1 SYSTEM STATUS CONTROL

Its specific visualisation allows the control of the system status, in order to detect eventual errors which do not allow the normal continuation of the operations.

To select this visualisation, refer to section “MODIFICATION OF THE DISPLAYED DATA”.

For this purpose, there are special error messages which will be displayed independently from the chosen visualisation, see section “MESSAGES”.

Before starting the weighing cycle or during the weighing cycle, one should pay attention to this information, in order to supply to the instrument the necessary commands for proceeding with the operations or restoring the system in the error status.

13.2 ENABLING / DISABLING THE WEIGHING CYCLE

To enable the weighing cycle one should:

- turn on the instrument with the electro mechanics disabled (- remove the consensus from downstream (IN 1 = 0Vdc), if not excluded in the << **diS.d.st** >> step; **TECH.MAN.REF.**).
- select the article to be weighed (only if one is using the instrument in the tolerance check mode).
- enable the consensus from downstream (IN 1 = 0Vdc), if not excluded in the << **diS.d.st** >> step;

The weighing and cadence belts will take on a specific condition (these can be still or in motion), depending on the parameter set in step << **ST.NSTR** >>.

If the belts are stopped, in order to start the weighing cycle, one should supply a restart impulse (IN.4).

NOTE: If the belts are not enabled make sure that the electro mechanic system is correctly powered, verifying the system status as described in the previous section.

To enable the weighing cycle with block for missing voltage, see section “CYCLE RESTORAL AFTER POWER OUTAGE”.

To disable the weighing cycle one should disable the consensus from downstream (remove the running) for a time greater than the one configured in step << **BLK.D.ST** >>: the weighing cycle is interrupted.

With the consensus from downstream excluded in the << **diS.d.st** >> step, the weighing cycle is always active.

To reenale the weighing cycle one should:

- enable the consensus from downstream (IN 1 = 0Vdc), if not excluded in the << **diS.d.st** >> step.
- press the RESTART/RESET button with belts stopped at the start-up (passo << **ST.NSTR** >> step set on **STOP**).

NOTE:

With consensus from downstream (IN 1 = 0Vdc) not excluded in the << diS.d.st >> step, all keys take on their functions and it's possible to turn the instrument off only with the weighing cycle disabled.

13.3 DESCRIPTION OF THE CYCLE PHASES

Once the cycle is enabled, the instrument enables the belts and is ready for the automatic acquisition of the weighs by following the phases described in the following sections.

13.3.1 WEIGHT ACQUISITION

The instrument can acquire the weigh in four ways depending on how the system has been configured (see the << Wgh.tyP >> step, TECH.MAN.REF.):

- at halt with a sensor,
- in motion with a sensor,
- in motion with two sensors
- without sensors.

13.3.1.1 AT HALT WITH 1 PHOTO CELL

The weight acquisition takes place with a halted weighing belt.

The weighing with a halted belt allows to obtain the best accuracy of the weighing system on the belt, but requests a greater time for the weigh acquisition, and consequently causes a decrease of the weighing cadence.

DESCRIPTION OF THE SYSTEM

On the weighing belt installed on the scale, a photo cell (the START one) is installed, for checking the presence of the object to be weighed and subsequent start of the weighing operations.

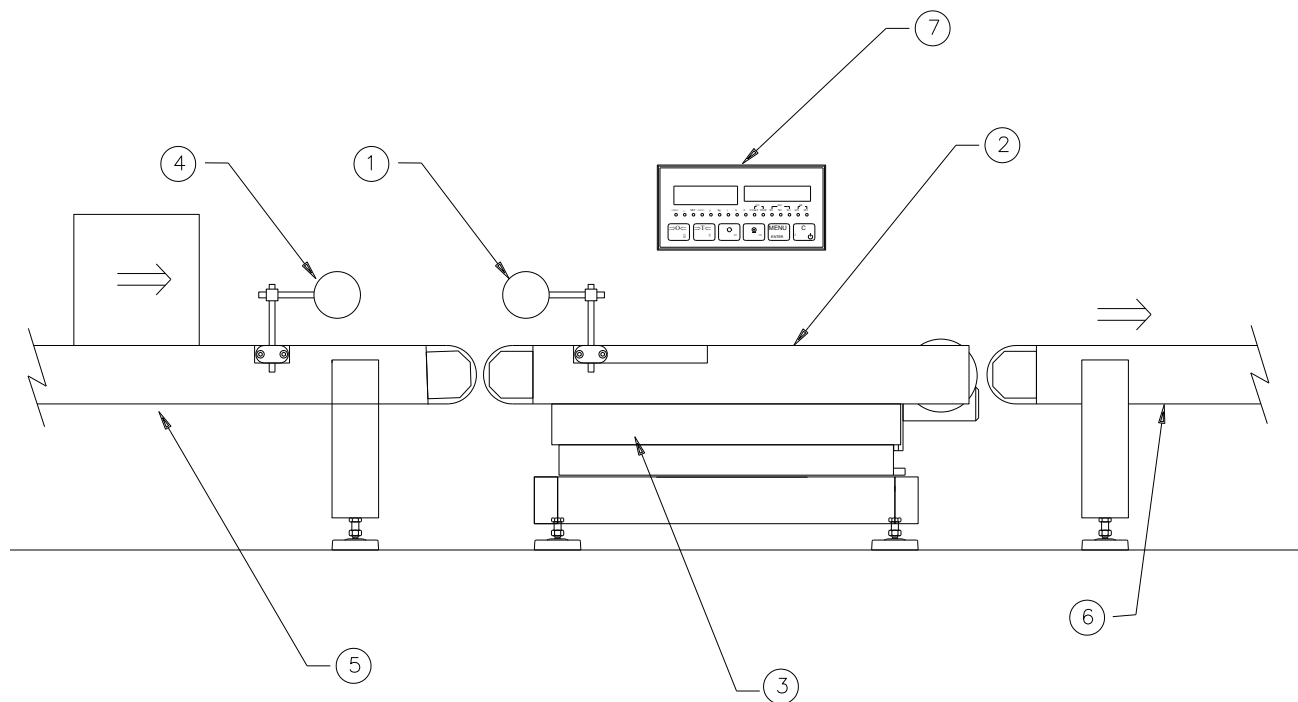
EXAMPLE:

- 1 WEIGH START PHOTO CELL
- 2 WEIGHING BELT
- 3 PLATFORM
- 4 CADENCE PHOTO CELL
- 5 CADENCE BELT
- 6 EXPELLER BELT

7 WEIGHT INDICATOR

The cadence belt supplies the packs to the weighing belt with the possibility of managing their flow, as described in section "MANAGEMENT OF CADENCE PHOTOCELL AND BELT".

FUNCTIONING

In the moment that the pack starts transiting on the weighing belt, in other words from the instant in which the pack presence photo cell is obscured, the instrument:

- 1) Waits for the positioning of the pack
- 2) Halts the weighing belt
- 3) Waits for the weight stability
- 4) Acquires the weight
- 5) Continues with the subsequent cycle phases (proceed in the reading of the following sections)
- 6) Is ready to carry out a new weigh

It's possible to set a minimum duration of the stability condition (<< **STB.WGT** >> step, **TECH.MAN.REF.**): if the weight is stable for a time greater than the one set, the instrument acquires the weigh otherwise it waits for the stability.

This setting can be useful when:

- The weight, after the belt halt, reaches right away the equilibrium but it stabilizes on its current value after a few seconds;
- One should acquire the weight of a material inside a container, carrying out the filling on the belt after the halt.

It's also possible to set a maximum duration of the instability condition (<< **T.M.PES** >> step, **TECH.MAN.REF.**): if the weight is unstable for a time greater than the one set, the instrument:

- Enters in an error condition: the instrument enables the alarm for the configured time, and if the visualisation of the SYSTEM STATUS is active, the "TIME-OUT" message is displayed.
- Waits for its restoral: the operator can restore the weight stability and restart the cycle by supplying a restart impulse (IN.4); the instrument will repeat the weighing operations from point 3.

13.3.1.2 IN MOTION WITH 1 PHOTO CELL

The weight acquisition takes place with the weighing belt in motion.

The weighing with the belt in motion allows a greater weigh acquisition speed, by obtaining in this way a greater weighing cadence.

The vibrations due to the belt motion however cause oscillations on the weight, and a decrease of the weighing system accuracy; this is compensated partially by the instrument during the special acquisition procedure, and partially by the calculated filter and the optimisation executed during the configuration.

DESCRIPTION OF THE SYSTEM

See following section.

FUNCTIONING

In the moment in which the pack starts to transit on the weighing belt, in other words, from the instant in which the pack presence photo cell is obscured, the instrument:

- 1) Waits for the positioning of the pack
- 2) Detects a series of weight values with the object in motion for a pre-established time interval (set in the << **T.M.PES** >>, **TECH.MAN.REF.**)
- 3) Calculates the weight, averaging the detected weight values.
- 4) Proceeds with the subsequent cycle phases (proceed in the reading of the following sections)
- 5) Is ready to carry out a new weigh

13.3.1.3 IN MOTION WITH 2 PHOTO CELLS

The weight acquisition takes place in the same way as the previous mode, but the use of a second photo cell allows to take advantage of all the possible weighing time depending on the pack that is to be weighed.

DESCRIPTION OF THE SYSTEM

On the weighing belt mounted on the scale, a photo cell is installed (the START one), for checking the presence of the object to be weighed and for the consequent start of the weighing operations; furthermore, a second photo cell is used (the STOP one), for checking the exit of the object to be weighed, and consequent end of the weighing operations.

EXAMPLE

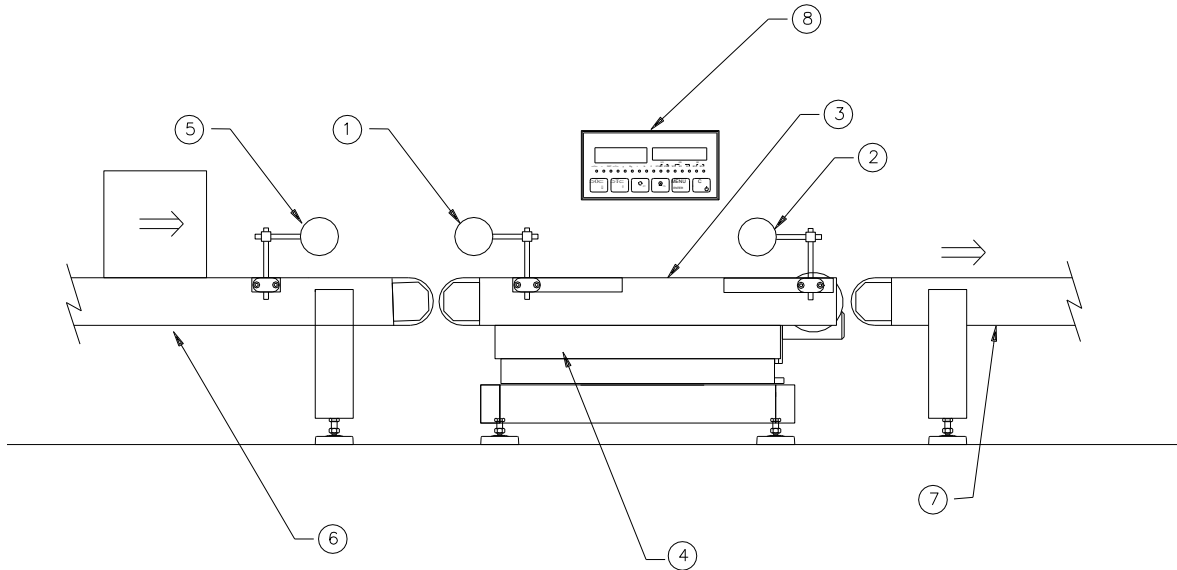

1. WEIGH START PHOTO CELL (first photo cell)
2. WEIGH STOP PHOTO CELL (second photo cell)
3. WEIGHING BELT
4. PLATFORM
5. CADENCE PHOTO CELL
6. CADENCE BELT
7. EVACUATING BELT
8. WEIGHT INDICATOR

FUNCTIONING

In the moment in which the pack starts to transit on the weighing belt, in other words, from the instant in which the pack presence photo cell is obscured, the instrument:

- 1) Waits for the positioning of the pack
- 2) Detects a series of weight values with the object in motion until the end weigh photo cell is obscured
- 3) Calculates the weight, averaging the detected weight values.
- 4) Proceeds with the subsequent cycle phases (proceed in the reading of the following sections)
- 5) Is ready to carry out a new weigh

13.3.1.4 AT HALT WITHOUT PHOTO CELLS

The positioning and weight acquisition takes place with the weighing system at halt, and it is eventually put into action only in the evacuation.

The trailing edge of the weight is used for starting the weigh acquisition and the leading edge for reenabling the weighing. The weight acquisition takes place upon the reaching of the stability or upon a set time.

EXAMPLE WITH WEIGHING BELT

The weighing belt, mounted on the scale, is connected to the expulsion relay and to the tolerance relays, for the management in the evacuation phase and subsequent end of the weighing operations.

EXAMPLE

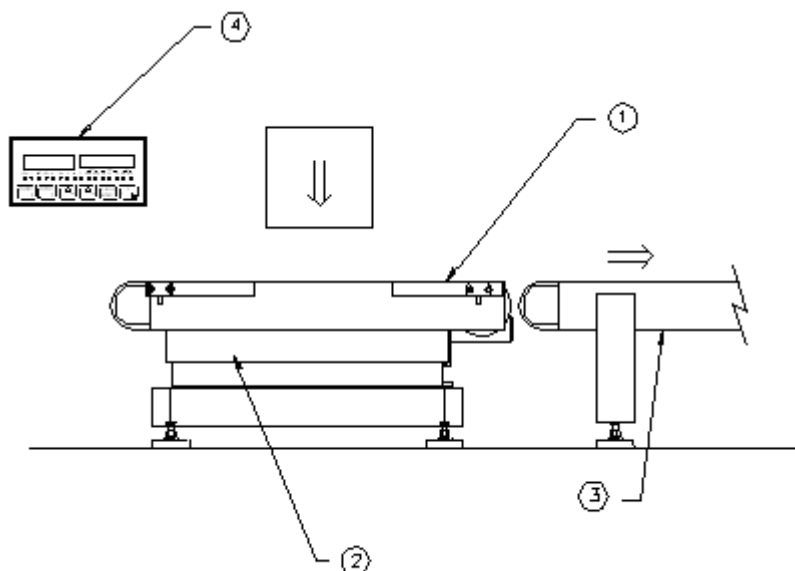

1. WEIGHING BELT
2. PLATFORM
3. EVACUATING BELT
4. WEIGHT INDICATOR

FUNCTIONING

The weigh starts when the pack is positioned on the belt. The instrument tests the presence of the pack through the leading edge of the weight, verifies if the weight variation obeys the conditions set in the configuration, **TECH.MAN.REF.**, then starts to execute the operations useful for achieving the weigh:

- a) the eventual weigh time starts (configured in step << T.M.PES >>)
- b) starts to acquire a set of weights
- c) waits for one of the fine weigh conditions to take place, in other words:
 - 1) the weight is stable, weight variation is in the range set in the configuration, **TECH.MAN.REF.**;
 - 2) ends the weight time (set in the configuration, **TECH.MAN.REF.**).
- d) When one of these conditions takes place, the instrument ends the weigh acquisition and calculates the best weigh. averaging the closest consecutive weights among the acquired ones.
- e) continues with the following cycle phases (read the next paragraphs)
- f) a new weigh is enabled when the weight goes below the threshold set in configuration (**TECH.MAN.REF.**)

13.3.1.5 IN MOTION WITH NO PHOTO CELL

The weight acquisition takes place with the weighing belt in motion.

The weight acquisition starts when the rising edge of the weight takes place. The new acquisition is enabled when the falling edge of the weight takes place.

The data acquisition terminates either on the falling edge of the weight or when the set time expires.

The in motion operative mode allows a faster weigh acquisition; in this way a higher weigh rate is achieved.

The belt motion causes weight oscillation and provides deterioration in the weigh precision. This deterioration is compensated by the instrument using the filter calculated in the system configuration phase.

EXAMPLE WITH WEIGHING BELT

The system is similar to the one with 1 or 2 photo cells, but it has no photo cells.

The pack presence check is achieved through the weight edges' monitoring.

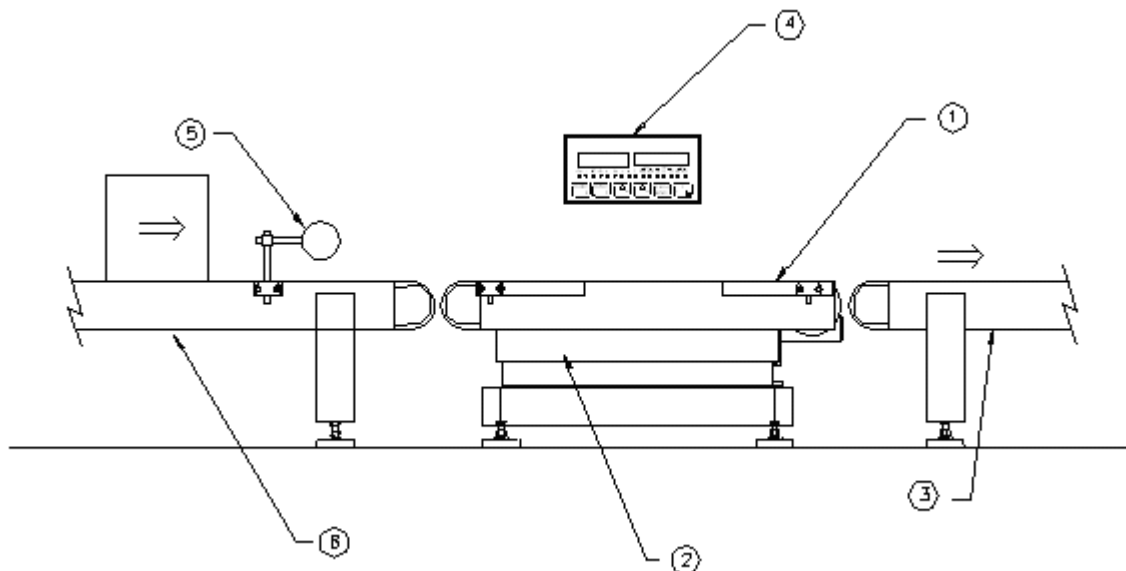

- 1. WEIGHING BELT
- 2. PLATFORM
- 3. EVACUATING BELT
- 4. WEIGHT INDICATOR
- 5. CADENCE PHOTO CELL
- 6. CADENCE BELT

FUNCTIONING

The weigh starts when the pack is positioned on the belt. The instrument tests the presence of the pack through the leading edge of the weight, verifies if the weight variation obeys the conditions set in the configuration, **TECH.MAN.REF.**, then starts to execute the operations useful for achieving the weigh:

- a) the eventual weigh time starts (configured in step << T.M.PES >>)
- b) starts to acquire a set of weighs
- c) waits for one of the fine weigh conditions to take place, in other words:
 - 1) the instrument checks for the pack absence monitoring the weight falling edge and verifies that the weight variation is in the range set in configuration, **TECH.MAN.REF.**;
 - 2) ends the weight time (set in the configuration, **TECH.MAN.REF.**).
- d) When one of these conditions takes place, the instrument ends the weigh acquisition and calculates the best weigh averaging the closest consecutive weighs among the acquired ones.
- e) continues with the next cycle phases (read the next paragraphs)
- f) a new weigh is enabled when the weight goes below the threshold set in configuration (**TECH.MAN.REF.**)

13.3.2 TOLERANCE CHECK

When the weigh is acquired, the instrument can follow two different ways, depending on the parameter set in the tolerance range enabling step << TST.TOL >>:

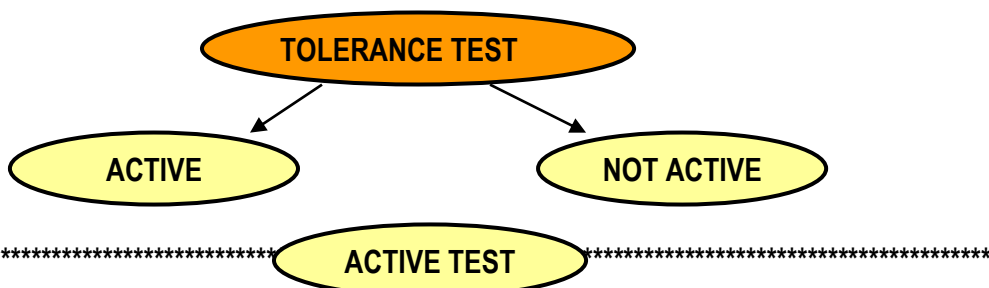

The instrument carries out the tolerance check, that is, it checks if the weight is within the tolerance interval set in the configuration, then:

- **IF THE WEIGHT IS WITHIN THE TOLERANCE INTERVAL**, the instrument executes the following sequence of operations:

- Totalization
- Weigh result display
- Belt Stop (if set)
- Evacuation

- **IF THE WEIGHT IS NOT WITHIN THE TOLERANCE RANGE:**
the instrument executes the following sequence of operations:

- Weigh correction (if set)
- Totalization
- Weigh result display
- Belt Stop (if set)
- Evacuation
- Automatic ejection (if set)

For operational details read the next sections.

The tolerance check interval may be set in 3 ways, as described in the next paragraphs and set in the step << **CHECK.t** >>.

In the following paragraphs the tolerance check range setting is described, as well as the functions related to the tolerance checking.



Once the weight is acquired, the instrument executes the totalization procedure, see paragraph "TOTALIZATION".

13.3.2.1 CHECKING WITH ARTICLE AND T1,T2,T3 TOLERANCE SETTING

The tolerance range is assigned by setting in the article the target weight (TARGET) and the tolerance values (T1, T2, T3). The latter values are weight values to be added or subtracted from the target in order to determine the weight thresholds. When filling in the article, the following fields have to be inserted: TARGET weight, and the tolerance values necessary for setting the tolerance range and for enabling the relays' functions (see paragraph "WEIGH RESULT INDICATION AND ENABLING OF THE LINKED OUTPUTS").

The weighing cycle starts only if the article is selected: by enabling the consensus from downstream (IN.1), the following error message is displayed "ARTICLE NOT SELECTED".

With invalid weight thresholds the message "NO RANGE SELECT." is displayed in the tolerance range display location (see paragraph "MODIFICATION OF THE DISPLAYED DATA").

It is possible to view every tolerance threshold related to the selected article: through the function **300**, linkable to the desired key (<< **F.Keys** >> step, **TECH.MAN.REF.**), with disabled weigh cycle (see paragraph "ENABLING / DISABLING THE WEIGHING CYCLE"), the display shows:

T3 -	1.000kg	Tolerance threshold with related weight threshold
Disable		Indication of enabled/disabled tolerance, for determining the tolerance range and the tolerance relay management

Scroll with the arrow keys ▲ ▼ the desired tolerance; press the C key to exit.

13.3.2.2 CHECKING WITH ARTICLE AND MINIMUM AND MAXIMUM THRESHOLD SETTING

The tolerance range is assigned by setting in the article the minimum and the maximum weight thresholds. The range is assigned as follows:

- by setting both the thresholds, the weight is within tolerance if its value is within the 2 thresholds
- by setting the minimum threshold only (maximum threshold equal to zero), the weight is within tolerance if its value is between the minimum threshold and the full scale capacity.

When filling in the article, the minimum and maximum thresholds have to be entered, their values may be modified quicker by pressing the **F2** and **F3** keys in the weighing environment,

- By pressing the **F2** key in the weighing environment, when the weighing cycle is disabled, the minimum threshold may be modified; insert the desired value and press the **ENTER** key to confirm.
- By pressing the **F3** key in the weighing environment, when the weighing cycle is disabled, the maximum threshold may be modified; insert the desired value and press the **ENTER** key to confirm.

The thresholds may be modified when the article is selected, the inserted thresholds are copied in the selected article.

The minimum and maximum thresholds govern the activation of the tolerance relays (see paragraph "WEIGH RESULT INDICATION AND ENABLING OF THE LINKED OUTPUTS").

The weighing cycle starts only if the article is selected: by enabling the consensus from downstream (IN.1), the following error message is displayed: "ARTICLE NOT SELECTED".

With invalid weight thresholds, the message "NO RANGE SELECT." is displayed in the tolerance range display location (see paragraph "MODIFICATION OF THE DISPLAYED DATA").

13.3.2.3 CHECKING WITHOUT ARTICLE AND FAST MINIMUM AND MAXIMUM THRESHOLDS SETTING

The tolerance range is assigned setting (without article management) the minimum and maximum weight thresholds:

- setting both the thresholds, the weight is in tolerance if its value is within the 2 thresholds
- setting the minimum threshold only (maximum threshold equal to zero), the weight is in tolerance if its value is within the minimum threshold and the scale capacity.

The setting is executed pressing the **F2** and **F3** keys,

- Pressing the **F2** key in the weighing environment, when the weighing cycle is disabled, the minimum threshold may be modified; insert the desired value and press the **ENTER** key to confirm.
- Pressing the **F3** key in the weighing environment, when the weighing cycle is disabled, the maximum threshold may be modified; insert the desired value and press the **ENTER** key to confirm.

The minimum and maximum thresholds define the activation of the tolerance relays (see paragraph "WEIGH RESULT INDICATION AND ENABLING OF THE LINKED OUTPUTS").

The weighing cycle starts only with valid thresholds: if the minimum threshold is greater than the maximum threshold, when the consensus from downstream is enabled (IN.1), the message "THRESHOLDS NOT VALID" is displayed.

With invalid weight thresholds the message "NO RANGE SELECT." is displayed in the tolerance range display location (see paragraph "MODIFICATION OF THE DISPLAYED DATA").

13.3.2.4 DETERMINATION OF TOLERANCE RANGE

In the function mode with article and tolerances, it is possible to select which negative tolerance (-T3, -T2, -T1) and which positive tolerance (+T3, +T2, +T1) set the valid range of the pack weight.

This function is useful when the negative tolerance value is different from the positive tolerance value, for instance when the valid weight is within the -T2 and +T3 thresholds.

In the technical set-up (<< **SET.RNG** >> step, **TECH.MAN.REF.**), one can set the tolerance range limits.

Below is an example in programming the combinations for obtaining the tolerance range shown in the figure. The weight is valid only if it's between TARGET - T2 and TARGET + T3.

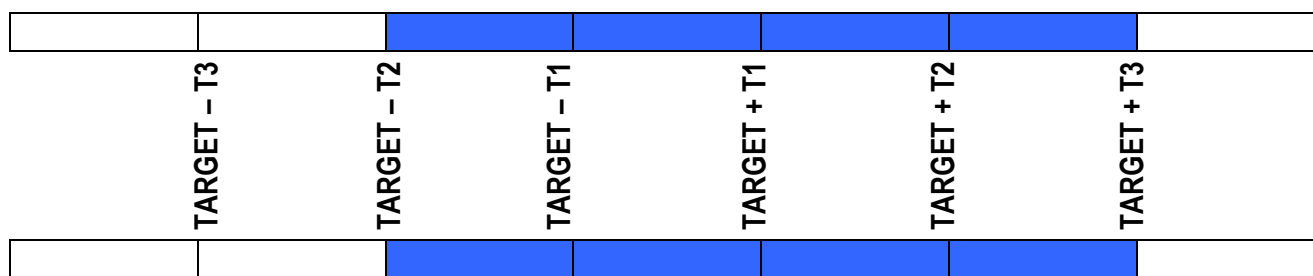

 : tolerance range

$WEIGHT < \text{than } (TARGET - T3) \rightarrow 0$

$(TARGET - T3) \leq WEIGHT < (TARGET - T2) \rightarrow 0$

$(TARGET - T2) \leq WEIGHT < (TARGET - T1) \rightarrow 1$

$(TARGET - T1) \leq WEIGHT \leq (TARGET + T1) \rightarrow 1$ (Always at 1, not modifiable)

$(TARGET + T1) < WEIGHT \leq (TARGET + T2) \rightarrow 0$

$(TARGET - T2) < WEIGHT \leq (TARGET + T3) \rightarrow 1$

$WEIGHT > \text{di } (TARGET + T3) \rightarrow 0$

The entry of the **T1**, **T2**, **T3** threshold values is made when entering the article (see section "ARTICLES DATABASE")
In order to achieve a tolerance check, an article has to be selected.

13.3.2.5 CHECKING QUANTITIES IN ml

When entering an article, it is possible to enter a density coefficient in order to check the volume quantity (ml) instead of in weight (g, kg, lb, t); if this coefficient is equal to 1,0000 the check is made on the weight, otherwise it is made on the volume.

!! IMPORTANT !!

In order to weigh in ml, calibrate the instrument in grams and set the database unit of measure in grams.

- The target of the article is directly taken into consideration in ml as well as the relative tolerances.
- By entering an article having a coefficient different from 1,0000, and pressing the **2nd F** and then the **F8** key it will be possible to switch the value shown by the display between the gross and net volume.
When printing one will note that the data which normally has the database unit of measure with the unit in ml.
- the ml indicator on the display will turn on indicating that the unit of measure is ml.

13.3.2.6 AUTOMATIC TARGET RECALCULATION AFTER N WEIGHS WITHIN TOLERANCE

This function allows to automatically recalculate the target of the selected article, after the scale has carried out a number of consecutive weighs within the tolerance set in the << **N.W.Tol** >> step (**TECH.MAN.REF.**).

When the number is reached, the target of the selected article is set to the value corresponding to the average of the totalized weighs within tolerance.

By setting 0, the function is disabled.

13.3.3 CORRECTION OF THE OUT OF TOLERANCE WEIGHT

By enabling the correction of the weight, or the mandatory correction of the weight, in the << TYP.ESP >> step, if the weight is out of tolerance, the instrument stops automatically the weighing belt after the weigh.

The alarm output OUT3 is also enabled for the set time (<< ALARM >> step) and on the display the message "CONFIRM WEIGHT" appears.

At that point the instrument executes two possible operations, depending if the correction or mandatory correction is set.

NON MANDATORY CORRECTION OF THE WEIGHT

The operator can:

- correct the weight before the restart of the belt, by adding or removing material in order to have the weight within the tolerances.
- not correct the weight and remove manually the pack;
- not correct the weight and leave the instrument to execute the automatic expulsion of the pack.

By giving the restart impulse (IN.4) with a stable weight the instrument:

- acquires automatically the weight in static mode
- executes the tolerance check on the new executed weigh
- executes the totalization (only if the operator has not removed manually the pack)
- executes the automatic expulsion if the weight is within the tolerance

NOTE:

Once the RESTART impulse is given, the instrument re-enables the weighing belt (OUT2), without checking if the manual expulsion of the out of tolerance weigh is carried out, and executes in any case, the automatic expulsion.

MANDATORY CORRECTION OF THE WEIGHT

The operator **MUST** correct the weight before the restart of the belt, by adding or removing material in order to have the weight within the tolerances.

By giving the restart impulse (IN.4) with a stable weight the instrument:

- acquires automatically the weight in static mode
- executes the tolerance check on the new executed weigh

At that point

- if the weight is within the tolerances the instrument executes the following operations:

- Totalization
- Weigh result indication
- Evacuation

- if the weight is out of the tolerance range, the instrument remains in the weight correction status. By giving the RESTART impulse, the message "OUT OF TOLERANCE" is shown.

In this way the final weight is always within the tolerances and consequently the expulsion is never carried out.

13.3.4 TOTALIZATION

The program's purpose is to manage the automatic totalization of the acquired weighs: once the weigh is acquired and the tolerance check and weight correction (depending on the configured functioning mode) are executed, it is automatically totalized if the following conditions are not respected:

- With an approved instrument, the acquired NET weight is at least of 20 divisions.
- With a non approved instrument, the acquired NET weight is greater than 0.

The totalized weight is automatically accumulated in the instrument's total (PARTIAL, GENERAL, GRAND TOTAL and LOT TOTAL), and the weighs progressives relative to the totals previously indicated increase.

Furthermore, if the article is active, the instrument increases both the total and the weighs progressive relative to the selected article.

NOTE: the scale totals (PARTIAL, GENERAL, GRAND TOTAL and LOT TOTAL), are not depending on the selected article.

13.3.4.1 TOTALIZATION OF ONLY THE WEIGHS WITHIN TOLERANCE

By setting the tolerance check function it is possible to choose if only the weighs within the tolerances have to be totalized (see << **tot.typ** >> step, **TECH.MAN.REF.**). Therefore only the weighs within tolerance are printed, and the totals are incremented, only if the weigh is within tolerance.

13.3.4.2 VISUALISATION AND CLEARING OF THE ACCUMULATED TOTALS

Each total can be momentarily viewed on the display or cleared independently through the printout, linking the function corresponding to the desired step (<<**F.Keys**>> step, **TECH.MAN.REF.**):

TOTAL	FUNCTION CODE FOR VISUALISATION	FUNCTION CODE FOR RESETTING
PARTIAL TOTAL	403	405
GENERAL TOTAL	406	408
GRAND TOTAL	409	411
ARTICLE TOTAL (only with selected article)	412	414
TOTAL LOT	-	417
ALL TOTALS (except the lot total, and the zeroed article total is relative to the selected article)	-	415

!! IMPORTANT !!

With the consensus from downstream excluded in the << **diS.d.st** >> step, **TECH.MAN.REF.**, the totals and progressives can be zeroed with the weighing cycle disabled, in other words, with instrument in lock from downstream status (IN. 1 = 0Vdc).

By recalling one of the clearing functions, the instrument requests a confirmation before proceeding with the cancellation: press ENTER to clear, C for continuing to accumulate.

It's possible to disable the confirmation request, in the **F.Mode** >> **totAL** >> **Reset** step, **TECH.MAN.REF.**.

In case of visualisation of the total, the instrument automatically exits the function after a few seconds.

NOTES:

- The clearing of the weight total causes also the reset of the relative number of weighs.
- The weight data of the cleared total will be updated only with the subsequent totalisation.
- The ARTICLE TOTAL is article specific, in other words, there is a total for EACH ARTICLE USED.
The other totals are GENERIC, and can be cleared INDEPENDENTLY ONE FROM THE OTHER (i.e. if one clears the Grand total, with the following totalisation, the other totals will continue to increment, while the Grand total will restart from 0).

13.3.4.3 CLEARING AND AUTOMATIC PRINTING OF THE PARTIAL TOTAL AFTER N WEIGHS

This function allows to automatically clear the partial total, after the scale has carried out a number of consecutive totalisations (both in and out of tolerance) set in the << **n.W.PRNT** >> step (**TECH.MAN.REF.**).

The relative weight data is also printed (see section "PRINTOUTS").

By setting 0, the function is disabled.

If the article is selected, the instrument prints and clears the article total instead of the partial total, and prints the relative weight data (see section "PRINTOUTS").

13.3.4.4 ADDITIONAL VALUE

Through function **400**, combinable with the desired key (<< **F.Keys** >> step, **TECH.MAN.REF.**), it's possible to set a value of up to 6 digits, which is summed to each totalisation, and can be recalled in the printing. The same value is linked

independently to three total types (PARTIAL, GENERAL, and GRAND TOTAL), in other words, it is possible to print three different values which will be cleared with the clearing of the relative total.

13.3.4.5 TICKET PROGRESSIVE

Through function **402**, combinable with the desired key (<< **F.Keys** >> step, **TECH.MAN.REF.**), it's possible to modify or clear the TICKET PROGRESSIVE (up to 5 digits). The TICKET PROGRESSIVE is a progressive number which increments of one UPON THE FIRST TOTALISATION SUBSEQUENT TO THE CLEARING OF THE PARTIAL TOTAL.

Furthermore through function **401**, combinable with the desired key (<< **F.Keys** >> step, **TECH.MAN.REF.**), it is possible to set the number of digits with which the TICKET PROGRESSIVE will be printed.

The number of settable digits varies from 4 to 16, organised in this way:

- if the actual digits of the total are less than the number of digits set in this step, the difference is filled with some spaces.
- if the actual digits are greater than the number of digits set in this step, only the ones actually entered are taken into consideration (counting from right to left).

The alignment of the total fields is on the left.

NOTE: The number of settable digits DOES NOT INCLUDE the comma.

13.3.5 WEIGH RESULT INDICATION AND ENABLING OF THE LINKED OUTPUTS

After the totalization procedure it is possible to show on the display, for a time set in the << **T.W.VIS** >> step, the totalized weight (in the weight box) and a message that indicates the result of the weigh, with the eventual weigh number if the weight is totalized (in the information section).

MESSAGE		DESCRIPTION
WITH INACTIVE ZOOM	WITH ACTIVE ZOOM	
OVERLOAD WEIGHT		It is not possible to totalize the weight greater than the maximum capacity + 9d.
WEIGHT NOT VALID		With approved instrument, it is not possible to totalize the weight lower than 1d.
UNDER 20e		With approved instrument, it is not possible to totalize the weight greater than zero, but lower than 20e.
OVER T3+ T.WGH. G00000001	> T3+ T.WGH.00000001	These indicate the position of the weight in respect to the set thresholds, and the eventual weighing number if the weight is totalized, in the check with article and tolerances.
OVER T2+ T.WGH.00000001	> T2+ T.WGH.00000001	
OVER T1+ T.WGH.00000001	> T1+ T.WGH.00000001	
IN TOLERANCE T.WGH.00000001	IN TOL. T.WGH.00000001	
UNDER T1- T.WGH.00000001	< T1- T.WGH.00000001	
UNDER T2- T.WGH.00000001	< T2- T.WGH.00000001	
UNDER T3- T.WGH.00000001	< T3- T.WGH.00000001	
OVER Tmax T.WGH.00000001	> Tmax T.WGH.00000001	These indicate the position of the weight in respect to the set thresholds, and the eventual weighing number if the weight is
IN TOLERANCE	IN TOL. T.WGH.00000001	

T.PES.00000001 UNDER Tmin T.WGH.00000001	< T1- T.WGH.00000001	totalized, in the check with or without article and setting of the minimum and maximum thresholds.
---	--------------------------------	--

The instrument has furthermore 7 tolerance outputs, in order to command, for example, an external traffic light, or a sorter.

After the totalization procedure, the output corresponding to the tolerance level in which the weight is detected, is activated; the activation time of the output is configurable (<< **TRF.LGT** >> step).

In case of belt stop (see section "STOP AND RESTART OF THE BELTS") the activation time is frozen, and the output remains active; in that way it is possible to select the product in the evacuation phase also in case of belt stop. The time restarts when the belts are restarted.

The managed tolerance outputs depend on the set functioning.

OUTPUTS MANAGED IN THE FUNCTIONING WITH ARTICLE AND TOLERANCES

It is possible to define, in configuration phase (<< **SET.THS** >> step), the tolerance outputs to be managed, by decreasing the tolerance levels; by enabling the tolerances, one defines the desired tolerance levels.

Below one finds a programming example of the combinations for managing 5 tolerance levels with correspondent outputs: Under TARGET – T2, from TARGET - T2 to TARGET – T1, from TARGET – T1 to TARGET + T1, from TARGET + T1 to TARGET + T2, over TARGET + T2.

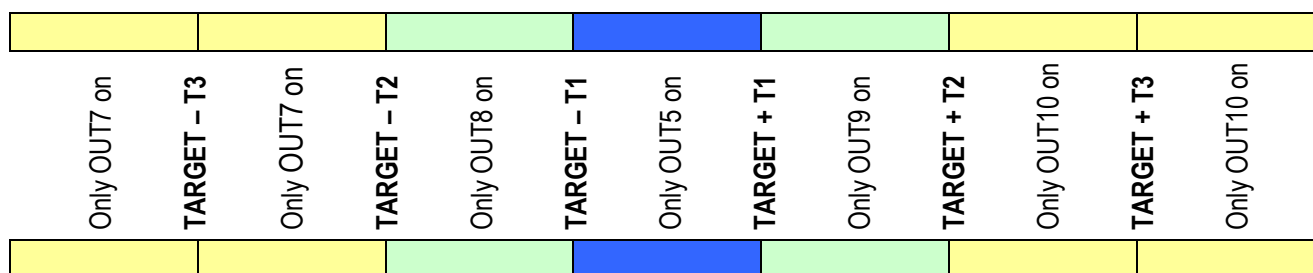

WEIGHT < of (TARGET – T3) → 0

(TARGET – T3) ≤ WEIGHT < (TARGET - T2) → 1

(TARGET – T2) ≤ WEIGHT < (TARGET - T1) → 1

(TARGET - T1) ≤ WEIGHT ≤ (TARGET + T1) → 1 (Always at 1, not modifiable)

(TARGET + T1) < WEIGHT ≤ (TARGET + T2) → 1

(TARGET – T2) < WEIGHT ≤ (TARGET + T3) → 1

WEIGHT > di (TARGET + T3) → 0

One enters the **T1**, **T2**, **T3** threshold values during the article insertion (see section "ARTICLES DATABASE").

To have the check with tolerances, in fact, the article must be selected.

MANAGED OUTPUT IN THE FUNCTIONING WITH OR WITHOUT ARTICLE AND SETTING OF THE MINIMUM AND MAXIMUM THRESHOLDS

The following outputs are managed to obtain 3 tolerance levels: weight under minimum threshold (OUT8), weight in tolerance (OUT5), weight over maximum threshold (OUT9).

The entry of the thresholds is carried out during the article insertion or directly in the weighing phase (see section "TOLERANCE CHECK").

13.3.6 STOP AND RESTART OF THE BELTS

Once the weight is totalized it could be necessary to stop (or leave stopped) the belts:

- a) after a weigh out of tolerance, to allow the manual expulsion (if the << **TYP.ESP** >> step);
- b) after every weigh, to allow eventual processings (by enabling the stop after the weigh stop in the << **WGh.stp** >> step);
- c) after a number of weighs out of tolerance, in order to allow the system verification.

On the other hand, the instrument restarts (or leaves active) the weighing and cadence belts and proceeds with the evacuation and the eventual automatic expulsion.

For the details on the belt stop mode and the following restart, continue the reading of the following sections.

13.3.6.1 STOP OF BELTS FOR WEIGH OUT OF TOLERANCE / MANUAL EXPULSION

This function stops automatically the weighing belt for weigh out of tolerance, allowing the manual expulsion of the pack (if enabled in the << **TYP.ESP** >> step).

The generic OUT 3 alarm output is furthermore enabled for the set time (<< **ALARM** >> step) and the "WAIT RESTART" message appears on the display.

To exit from the error status, one has to give a RESTART impulse (IN.4): the belts restart instantaneously.

NOTE:

Once the restart impulse is given, the instrument reactivates the weighing belt (OUT2), without controlling that the expulsion of the pack out of tolerance is effectively carried out.

13.3.6.2 STOP OF BELTS AFTER EVERY WEIGH

It is possible to decide if the weighing belt must be always stopped after the weight acquisition and wait a restart impulse (IN.4) before reactivating it, allowing eventual processings before the evacuation; see the << **WGh.stp** >> step.

The "WAIT RESTART" message appears on the display.

To restart the belts one has to give a RESTART impulse (IN.4): the belts restart instantaneously.

13.3.6.3 STOP OF BELTS AFTER A NUMBER OF WEIGHS OUT OF TOLERANCE

This function stops automatically the weighing belt when a number of **consecutive** out of tolerance weighs (set in the << **n.W.STOP** >> step) is reached.

By setting the 0 value, the function is disabled.

The generic OUT 3 alarm output is furthermore enabled for the set time (<< **ALARM** >> step) and the "STOP FOR WEIGH ERRORS" message appears on the display.

To exit from the error status, one has to give a RESTART impulse (IN.4): the belts restart instantaneously.

13.3.7 EVACUATION AND AUTOMATIC EXPULSION

Once the belts restart, the instrument carries out the evacuation and the eventual automatic expulsion of the pack (if it is enabled in the << **TYP.ESP** >> step), on other words:

- the set evacuation time starts (<< **EVAC.** >> step), useful for the eventual weighing belt autozero (see following section),
- it waits the activation delay of the expulsion output (OUT4) (set in the << **R.ESP.** >> step or in the article if the << **Rit.Esp.** >> step is enabled); after that, it activates the expulsion output (OUT4) for the set time (<< **I.ESP** >> step).

13.3.8 WEIGHING BELT AUTOZERO

The automatic zero function of the weighing belt allows to automatically restore the gross zero of the instrument during the weighing cycle, by locking automatically the belts for the required time, if necessary.

The automatic zero can enter into function:

automatically, when the cycle is re-enabled and the weight is different from zero, if it has been enabled the << **0.START** >> step.

automatically, when the number of minutes (since last zeroing) set in the << **0.BELT** >> step configured on **TIME (TECH.MAN.REF.)** have elapsed:

- if one sets the **0** value, the autozero never enters into function automatically;
- if one sets the **n (>0)** value, if the weight is different from 0, the instrument executes the autozero function. The minutes counting starts when the instrument is started and restarts when a zero or a tare is executed.

The zero function is executed also when the cycle is disabled.

Once the set minutes have passed, if the system is in the weighing phase of a pack, the autozero procedure is executed when the weighing is completed.

automatically, when the number of weighs (in tolerance as well as out of tolerance) set in the << **0.BELT** >> step configured on **WEIGHS (TECH.MAN.REF.)** have been executed:

- if one sets the **0** value, the autozero never enters into function automatically;
- if one sets the **1** value, at the end of each weigh the instrument waits for the evacuation time (<< **EVAC** >> step, **TECH.MAN.REF.**) and executes the autozero function if
 - a) the belt is empty (instrument in "PACK WAIT" status, no pack on the belt or in "POSITIONING") and
 - b) the weight is different from 0 (belt out of zero)
- if one sets the **n (>1)** value, the instrument executes the autozero function after having completed the number of configured weighs, **n**

manually, at the end of the eventual weigh being made, if the ZERO key has been pressed during the weighing cycle.

It is possible to decide to execute the automatic zero with the belt stopped or in motion << **0.type** >>, (**TECH.MAN.REF.**).

PROCEDURE:

If the automatic zero procedure has been activated, the instrument maintains the weighing belt active for the evacuation time

(<< **EVAC.** >> step (**TECH.MAN.REF.**)), so that the weighed pack can evacuate from the weighing belt, and it locks the cadence belt if a pack is detected in front of the cadence photocell; the "AUTOZERO EXECUTION" message appears on the display.

Once this time has passed, the automatic zero of the belt is made, in two possible ways:

stopped:

- the weighing belt is stopped
- wait for the weight stability
- automatic zero of the belt
- restart of the weighing and cadence belts (if stopped)

in motion:

- the instrument leaves the weighing belt active
- wait for the weight stability
- automatic zero of the belt
- restart of the cadence belt (if stopped)

CONDITIONS FOR ZEROING

Independently from the automatic zero execution way, the weight can be zeroed only if it is within the percentage set in the << **0.PErC** >> step (**TECH.MAN.REF.**) and with a stable weight.

Otherwise the instrument searches the zero for a set time (during which the display shows the "AUTOZERO EXECUTION" message) at the end of which it emits an error sound signal: the automatic zero has not been made.

With automatic zero at time or at the re-enabling of the weighing cycle, the system goes into alarm condition, the display shows the "AUTOZERO FAILED" message and a RESTART impulse is required to restart. Once the RESTART impulse is given, the automatic zero enter into function.

With automatic zero at weighs, the system doesn't go into alarm condition and allows the pack to continue.

If a tare is active, the automatic zero of the belt is not executed.

13.4 CYCLE LOCK AND INTERRUPTION OF THE WEIGH (NON WEIGHED PACK)

During the functioning it is possible that the cycle is locked during the weigh acquisition, by verifying one of the lock conditions described in the following sections.

Once the system is restored, and the cycle is eventually re-enabled, the instrument verifies if the acquisition of the weigh was stopped before the lock and it executes the following operations:

- if the acquisition is not terminated:
 - 1) the "NON WEIGHED PACK" message appears depending on the selected visualization (see section "MODIFICATION OF THE DISPLAYED DATA");
 - 2) a RESTART impulse is required in order to restart: the operator can now remove manually the weight for its repositioning on the cadence belt, in order to acquire again the weight.

NOTE: Once the RESTART impulse is given, the instrument activates the weighing belt (OUT2), without controlling if the pack has been removed; in any case, the instrument carries out the automatic expulsion in order to remove the non weighed pack but without totalising.

- if the acquisition is terminated
 - 1) the "WEIGHED PACK" message appears depending on the selected visualization (see section "MODIFICATION OF THE DISPLAYED DATA");
 - 2) a RESTART impulse is required to restart: the instrument will resume the cycle phases at the point in which these were interrupted.

NOTE: in case of downstream block or motor block, if the belts in motion at start-up are set (<< **ST.NSTR** >> step), when the cycle is re-enabled the instrument restarts automatically without showing the "WEIGHED PACK" message and without waiting for the RESTART impulse.

13.4.1 DOWNSTREAM BLOCK

The system can handle the automatic disabling of the cycle from the downstream of the belt, when in the belt downstream lock condition due to processing or error.

If it is not possible to manage the disabling of the cycle at the end of the weigh, in order to avoid the cancellation of the weigh in progress, it can be useful to set a delay time of the downstream lock (<< **BLK.D.ST** >> step): the instrument waits for the set time period to pass before disabling the cycle; during this time, furthermore, the instrument disables automatically the cycle if the weigh is terminated.

Set a minimum time equal to the belt transition time.

13.4.2 EMERGENCY / MOTOR LOCK

Through the EMERGENCY / MOTOR LOCK input (IN.6) it is possible to manage an external signal for the instantaneous cycle lock, caused by a generic EMERGENCY condition or motor lock condition

When the signal is activated, the instrument disables the cycle, activates the generic alarm (OUT3) for the configured time and the "MOTOR ALARM" message appears on the display.

It is possible to set a minimum time of the signal to disable the cycle, avoiding eventual noise (see << **BLK.MOT** >> step).

13.4.3 UNDERLOAD / OVERLOAD WEIGHT LOCK

Through the underload / overload weight lock function, it is possible to disable the cycle if a weight lower than -100d is detected (with approved instrument) or greater than the maximum weight + 9d, for a time greater than the value set in the << **W.UN.OV** >> step.

By setting the time at 0 the function is disabled.

13.5 CYCLE RESTORAL AFTER POWER OUTAGE

When turning on the indicator after a power outage with a pack on the weighing belt, the instrument does not carry out the automatic zero at start-up, allowing the eventual evacuation or manual removal of the pack: the "POWER OUTAGE" message appears depending on the selected visualization (see section "MODIFICATION OF THE DISPLAYED DATA").

By enabling the consensus from downstream the instrument verifies if the acquisition of the weigh is terminated before the power outage and it executes the following operations:

- if the acquisition is not terminated:

- 1) the "NON WEIGHED PACK" message appears depending on the selected visualization (see section "MODIFICATION OF THE DISPLAYED DATA");
- 2) a RESTART impulse is required to restart: the operator must remove manually the weight for the repositioning on the cadence belt, in order to acquire again the weight.
- 3) Once the RESTART impulse is given, the instrument executes the autozero at start-up, as described in section "POWER SUPPLY & START-UP".

NOTE: Once the RESTART impulse is given, the instrument executes the autozero, without controlling if the pack has been removed.

- if the acquisition is terminated
 - 1) the "WEIGHED PACK" message appears depending on the selected visualization (see section "MODIFICATION OF THE DISPLAYED DATA");
 - 2) a RESTART impulse is required to restart: the operator must remove manually the weight.
 - 3) Once the RESTART impulse is given, the instrument executes the autozero at start-up, as described in section "POWER SUPPLY & START-UP".

NOTA: The instrument carries out the autozero at start-up if the function is enabled and the weight on the scale is within the percentage set in the << Auto 0 >> step (TECH.MAN.REF.).

13.6 MANAGEMENT OF CADENCE PHOTOCELL AND BELT

It is possible to manage a cadence photo cell, which gives the possibility to stop the cadence belt each time that the foreseen cadence is not respected.

This function allows to avoid that, during the weighing of a package, the next pack arrives on the weighing belt, compromising the weigh under way.

From the moment in which the cadence photo cell (IN.3) is obscured, if the instrument is in weigh acquisition, in execution of the belt automatic zero or the weighing belt is stopped, the cadence belt is stopped (off).

The cadence belt is re-enabled only after the instrument has acquired the weigh, has finished executing the automatic zero or the weighing belt has been re-enabled.

The management of the cadence is performed in two different ways depending on how the parameter << 2.PAC >> is set: << 2.PAC >>=1/2/3/ ... seconds ... If a package is in weighing and, simultaneously, the cadence photocell is obscured, the indicator stops the belt and restarts it after the expiration of this time.

Note: this time can start on the falling edge or on the rising edge of the photocell (parameter << cad.t.e >>)

When the delay time between two parcels ends, and one of them is still being weighed, the following package goes on the belt anyway. It is therefore necessary to set an appropriate weighing time << T.M.PES >>.

<< 2.PAC >>=0 : by setting this value the best management of the tape is reached. If a package is in weighing, as the cadence photocell is obscured the tape immediately stops, and then it restarts just when the parcel weighing operation is fully performed.

Therefore, take care not to obscure accidentally the cadence photocell during the weighing.

When a pack is in weighing and the delay time between the two packs ends, the next pack is positioned on the belt, regardless of whether the first pack is in positioning or in weighing. Therefore one has to set properly the weight time << T.M.PES >>.

13.7 ALARM OUTPUT MANAGEMENT

There are 6 cases which determine the conditions for the alarm activation:

- Weight out of tolerance (only if the manual expulsion has been selected), with << TST.TOL >> step enabled.
- The number of weighs out of tolerance has reached the value set in the << n.W.STOP >> step
- Weight unstable for a time greater than the value set in step << T.M.PES >> (only if the weighing at halt is selected) .
- Pack not weighed at the restart of the belts (after the lock from downstream which took place before the end of the weigh).

- Weight greater than the maximum Capacity + 9d or less than -100d, for a time greater than the value configured in step << **W.UN.OV** >> (only with time greater than 0).
- EMERGENCY / MOTOR LOCK input (IN6) active for a time greater than the value configured in step << **BLK.MOT** >>.

The impulse duration is set in << **ALARM** >> step.

14. PRINTOUTS

The instrument is fitted with different print functions, which may be used while weighing, and of 30 print formats, in other words, 30 different memory storages, each of which contain a programmable printout.

The print executed by these functions depends on the print format linked to it; see the following section for the linkages. The format linking function allows to execute various printouts, by changing the linked format each time.

The available functions are:

SIMPLE PRINTOUT:

- Programmable printout -

Through the PRINT key **F5** key one prints the linked format, **without executing the totalisation**.

With the APPROVED instrument:

- The printing works if there is a NET WEIGHT of at least 20 divisions.
- The printout is re-enabled depending on how the << **react** >> parameter is configured

With the NON APPROVED instrument:

- The printing works if there is a NET WEIGHT greater than zero.
- The simple printout is always active (the programming of the << **react** >> parameter is not taken into consideration).

TOTALIZATION WITHIN TOLERANCE, OUT OF TOLERANCE, WITHOUT TOLERANCE TEST - Programmable printout

After a totalisation, depending on the check result, the printing is made of one of the linked formats (WITHIN TOLERANCE, OUT OF TOLERANCE WITHOUT TOLERANCE TEST).

With the APPROVED instrument:

- The printing works if there is a NET WEIGHT of at least 20 divisions.

With the NON APPROVED instrument:

- The printing works if there is a NET WEIGHT greater than zero.

PRINTING OF THE HEADING (upon the first executed totalisation)

- Programmable printout -

If a format is linked to the ("FIRST TOTALISATION HEADING") first totalization, will cause the printing of this format and then the format linked to the totalisation function.

PARTIAL TOTAL

- Programmable printout -

By pressing the **F8** key, the resetting of the PARTIAL TOTAL and the printing of the linked format are made.

Alternatively, it's possible to automatically execute the function, as described in section "CLEARING AND AUTOMATIC PRINTING OF THE PARTIAL TOTAL AFTER N WEIGHS".

NOTE: the instrument allows to use a progressive number increasing every time the partial total is cleared, see section "TICKET PROGRESSIVE" for further details.

GENERAL TOTAL

- Programmable printout -

By pressing the **F9** key the resetting of the GENERAL TOTAL and the printing of the linked format are made.

GRAND TOTAL

- Programmable printout -

By pressing the **F10** key, the resetting of the GRAND TOTAL and the printing of the linked format are made.

SELECTED ARTICLE TOTAL

- Programmable printout -

With the selected article, by pressing the **2ndF** and **F1** keys the resetting of the ARTICLE TOTAL is made and the linked

format is printed.

LOT TOTAL

- Programmable printout -

by pressing the **2ndF** and **F3** keys, or in alternative by pressing at length the RESET / RESTART button (IN.4), the LOT TOTAL is automatically cleared and the relative format is printed.

RESULT OF THE CALCULATOR

- Programmable printout -

Once terminated the operation with "CALCULATOR" function the linked format is printed. See section "CALCULATOR".

14.1 LINKING OF THE FORMATS TO THE PRINT FUNCTIONS

Through function **200**, combinable with the desired key (<< **F.KEYS** >> step, **TECH.MAN.REF.**), one accesses the linking of the print formats (configurable in the **SetuP** >> **Serial** >> **Prn.FMt** step **TECH.MAN.REF.**) to the 12 programmable print functions:

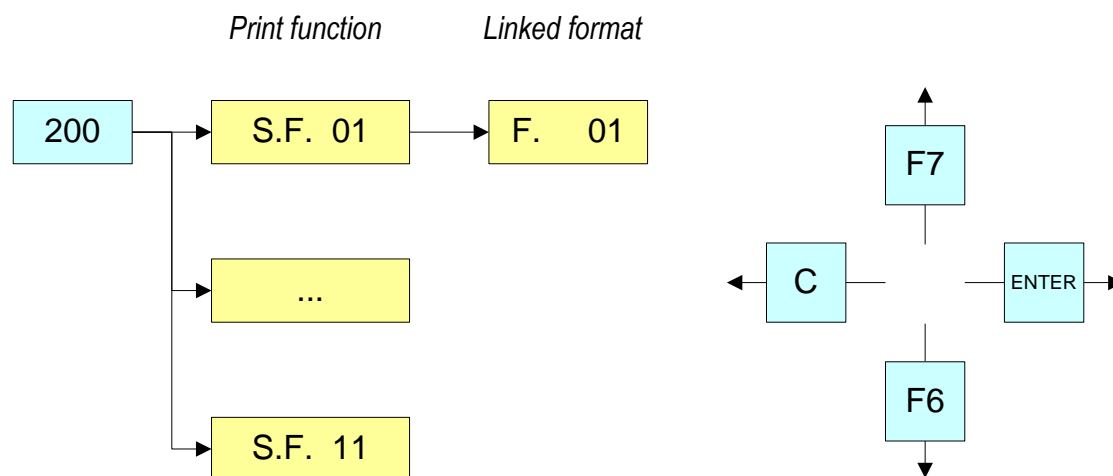

Print function	Key	Linked step
SIMPLE PRINTOUT	F5	S.F.01
TOTALISATION WITHIN TOLERANCE	Automatic entry	S.F.02
TOTAL LOT	2ndF and F3 sequence	S.F.03
HEADING OF THE FIRST TOTALISATION	Automatic entry	S.F.04
SELECTED ARTICLE TOTAL	2ndF and F1 sequence	S.F.05
PRINTING THE PARTIAL TOTAL	F8 or Automatic entry	S.F.06
PRINTING THE GENERAL TOTAL	F9	S.F.07
PRINTING THE GRAND TOTAL	F10	S.F.08
CALCULATOR (see section "CALCULATOR")	Automatic entry	S.F.09
TOTALISATION WITHOUT TOLERANCE TEST	Automatic entry	S.F.10
TOTALISATION OUT OF TOLERANCE	Automatic entry	S.F.11
PRINT UPON TURNING ON	Automatic entry	S.F.12

!! IMPORTANT !!

With the consensus from downstream excluded in the << **diS.d.st** >> step, **TECH.MAN.REF.**, the print functions recalled by key or input are possible only with a disabled weighing cycle, in other words, with consensus from downstream (IN. 1 = 0Vdc).

The instrument is fitted with 30 print formats, in other words, 30 different storages, each of which contain a programmable printout.

The formats are programmable in the **SEtuP** >> **SEriAL** >> **Prn.FMt** step in the SET-UP environment (**TECH.MAN.REF.**).

It's possible to quickly link a stored format to each print function listed in the table; this function allows also to execute various printouts with the same print function, changing the linked format from time to time.

TO LINK THE FORMAT:

- Recall function **200**, combinable with the desired key (<< **F.KEYS** >> step, **TECH.MAN.REF.**).

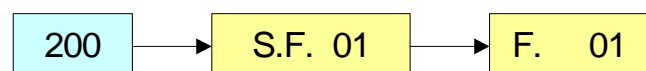

- The display shows:

XX in which:
XX indicates the number of the function to which the print format is linked.

- Select the print function (for example S.F. 01) through the arrow keys ▲ ▼ and press the **ENTER** key
- Once entered, the display shows:

XX in which:
XX indicates the number of the format to be linked to the function.

- Type the format number and press **ENTER**.

NOTE: In order to not link any format to a vector one should enter the number 00.

14.1.1 QUICK LINKING OF THE FORMATS

By linking the number of a specific print function to the function **200** (preamble function in the << **F.KEYS** >> step, **TECH.MAN.REF.**), it is possible to access directly to the modification of it with a direct key, for example F1 key to quickly link the S.F. 1, and F2 key to quickly link the S.F. 2.

Furthermore for some print functions the desired formats can be quickly linked by setting directly the corresponding code (function) to the desired key (<< **F.KEYS** >> step, **TECH.MAN.REF.**) without having to program the preamble::

CODE	QUICK LINKING FUNCTION	PRINT FUNCTION
200	Format linking to the Simple Printout (Prn.Fmt)	S.F. 01
201	Format Linking to the Totalisation (SND.FMT)	S.F. 02

TO QUICK LINK THE FORMAT:

- Recall the desired print function, by pressing the linked key (<< **F.KEYS** >> step, **TECH.MAN.REF.**).
- The display shows:
XX in which:
XX indicates the number of the format to be linked.
- Type the format number and press **ENTER**.

NOTE: In order to not link any format to a print function one should enter the number 00.

14.2 LOT WEIGHS REPORT

Through the print functions described in the previous section, it is possible to create a report of the sampling made, by printing a heading, the weight of each weighed object and the lot end, with all the statistical data of the weighs of the lot total and the accumulated total.

14.2.1 PRINTING OF THE HEADING

The data which is configured for the format linked to the "FIRST LOT TOTALIZATION HEADER" function allows to create an independent print format which is printed as a heading when the first totalization is done. It is useful for printing the **COMPANY HEADING** or other **DESCRIPTIONS**, when it is not necessary to print these in a single accumulation operation.

IND.ART. 0	
XL PACKAGE	
TARGET	5.000kg
START DATE AND TIME	
20/01/05	12:08:48

WEIGH	NET
1	5.002kg

14.2.2 TOTALIZATION

The data configured for the totalisation formats (WITHIN TOLERANCE, OUT OF TOLERANCE WITHOUT TOLERANCE TEST) allows to create various formats for each outcome of the check; depending on the outcome of the check, the relative format is printed. It is useful to print all the totalised weights by eventually indicating the weighs out of tolerance.

2	5.002kg
3	5.002kg
4	5.002kg
5	5.002kg

14.2.3 TOTAL LOT

The data configured for the "LOT TOTAL" format allows to create a format containing all the statistical data of the weighs of the lot total and the accumulated lot total, which is printed as a LOT TOTAL, see section "VISUALISATION AND CLEARING OF THE ACCUMULATED TOTALS".

AVERAGE WEIGHT	5.0020kg
STD. DEV.	2.3967kg
WEI. ABOVE T1	0
WEI. ABOVE T2	0
WEI. ABOVE T3	0
WEI. UNDER T1	0
WEI. UNDER T2	0
WEI. UNDER T3	0
OK WEIGHS	6
MAX WEIGHT	5.002kg
MIN WEIGHT	5.002kg
T.LOT.WEI.	5
T.LOT.NET	15.010kg
END DATE AND TIME	
20/01/05	14:15:20

14.3 REPETITION OF THE LAST EXECUTED PRINTOUT

By pressing in sequence the **2ndF** and **F5** keys the last executed printout is repeated; this function can not be executed two times.

14.4 STANDARD PRINTING FORMATS

The << **DEF.PRN** >> parameter of the set-up environment allows to enable the standard printouts for the TPR printer.

NOTE: By enabling these printouts all the formatted print formats will be CANCELLED and will be SUBSTITUTED by the standard formats, linked to the print functions.

Below are the standard printouts of the instrument:

WEIGHS CYCLE REPORT
(WITH ACTIVE ARTICLE AND TOLERANCE CHECK)

WEIGHS CYCLE REPORT
(WITHOUT ARTICLE AND TOLERANCE CHECK)

REPORT START
(WEIGHING CYCLE BEGINNING)
(<< Prn.F.4 >>)

JOHN SMITH LTD.
157 INDEPENDENCE AVE.
LONDON

ART.IND. 0
XL PACKAGE

TARGET 5.000kg

BEGIN TIME DATE
20/01/05 12:08:48

WEIGH	NET
1	5.002kg
2	5.002kg
3	5.002kg
4	5.002kg
5	5.002kg

REPORT END
(WEIGHING CYCLE END)
(<< Prn.F.3 >>)

THE ZEROING OF
THE LOT TOTAL
WILL ENSUE

WGT. AVG.	5.0020kg
STD. DEV.	0.0000kg
WEIG. OVER T1	0
WEIG. OVER T2	0
WEIG. OVER T3	0
WGT. UNDER T1	0
WGT. UNDER T2	0
WGT. UNDER T3	0
WEIGHS OK	6
WGT. MAX	5.002kg
WGT. MIN	5.002kg
T.LOT.WGTS.	5
T.LOT.NET	25.010kg
END TIME DATE	20/01/05 14:15:20

TOTALISED
WEIGHS
(<< Prn.F.9 >>)

JOHN SMITH LTD.
157 INDEPENDENCE AVE.
LONDON

START TIME DATE
20/01/05 12:08:48

WEIGH	NET
1	5.002kg
2	5.002kg
3	5.002kg
4	5.002kg
5	5.002kg

WGT. AVG.	5.0020kg
STD. DEV.	0.0000kg
WGT. MAX	5.002kg
WGT. MIN	5.002kg
T.LOT.WGTS.	5
T.LOT.NET	25.010kg
END TIME DATE	20/01/05 14:15:20

ARTICLE TOTAL
(<< Prn.F.5 >>)

JOHN SMITH LTD.
157 INDEPENDENCE AVE.
LONDON

ART. IND. 0
XL PACKAGE
50x30x10

T . ART NET 50.00kg
T . ART GROSS 50.00kg
T . ART TARE 0.00kg
T . ART WGTS. 25
21/01/05 - 08:26:05

PARTIAL TOTAL
(<< Prn.F.6 >>)

NET PART. T. 50.00kg
GROS. PART. T. 50.00kg
TARE PART. T. 0.00kg
WGTS PART. T. 25
ADD. PART. T. 0
21/01/05 - 08:26:05

GENERAL TOTAL
(<< Prn.F. 7 >>)

NET GEN. TOT. 50.00kg
GROS. GEN. TOT. 50.00kg
TARE GEN. TOT. 0.00kg
WGTS GEN TOT. 25
ADD. GEN. TOT. 0
21/01/05 - 08:26:05

GRAND TOTAL
(<< Prn.F.8 >>)

NET GRAND T. 50.00kg
GROS. GRAND T. 50.00kg
TARE GRAND T. 0.00kg
WGTS GRAND T. 25
ADD. GRAND T. 0
21/01/05 - 08:26:05

PRINT KEY
(<< Prn.F. 1 >>)

JOHN SMITH LTD.
157 INDEPENDENCE AVE.
LONDON

ART. IND. 0
XL PACKAGE

GROSS 2.000kg
TARE 0.000kg
NET 2.000kg
20/01/05 12:08:48

15. OTHER FUNCTIONS

15.1 DIAGNOSTIC PERIPHERALS

Through function 118 combinable with the desired key (<<F.Keys >> step, **TECH.MAN.REF.**), one enables the diagnostic peripherals function.

The display shows:

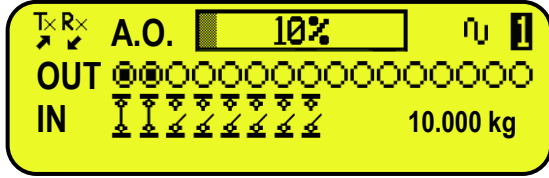

NOTE: If the expansion board is not present, 2 inputs and 4 outputs are displayed.

STATUS	DESCRIPTION
ANALOGIC OUTPUT(A.O)	Analogic output value express in percent.
OUTPUTS (OUT)	Status output, non active (○) or active (●).
INPUTS (IN)	Status input, non active (⚡) or active (⚡).
SERIAL COMUNICATIONS (Tx Rx)	The serial communication is active with external device.
WEIGHT	Status of the weight: - with unloaded scale; - with unstable weight;
SCALE	Number of the active scale (always) and the relative weight loaded.

15.2 COM DATA DIAGNOSTIC

Through function 119 combinable with the desired key (<< F.Keys >> step, **TECH.MAN.REF.**), one enables the Com data diagnostic function. The display shows:

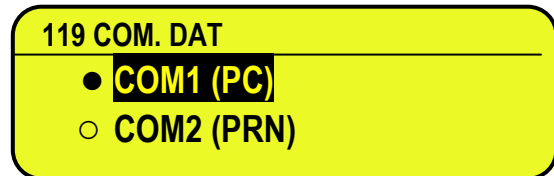

In the first screen one selects the port on which the diagnostic control should be executed. While in the second screen, one selects the code that one wants to use for viewing the data in transit.

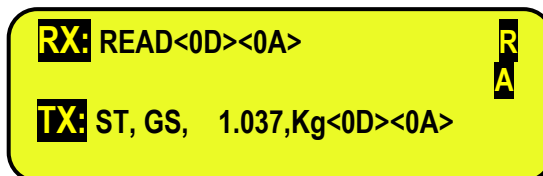

When the data on the RX and TX reception and transmission lines are correctly displayed, then the functioning of the relative serial line is considered to be correct.

NOTE: By pressing the **.HELP** key, it's possible to see the keys list used in the menu.

15.3 CALCULATOR

Through function **114** combinable with the desired key (<<**F.Keys** >> step, **TECH.MAN.REF.**), one enables the calculator function.

- **ADDITION**
- **MULTIPLICATION**
- **SUBTRACTION**

Procedure:

- Enter the first value using the numerical keyboard.
- Press **F1** to add, **F2** to multiply, **F3** to subtract the value.

TERMINATE THE OPERATION:

- **TYPE** the second value and **PRESS ENTER**: the result will be shown for a few seconds on the display.
- **TYPE** the second value and **PRESS TARE**: the result will be shown for a few seconds on the display and will be added (in the addition and multiplication case) or subtracted (in the subtraction case) to the current tare value.
- **PRESS 2nd F**: the NET weight on the scale will be used as a second value and the result will be shown for a few seconds on the display.

In the end the printing of the "CALCULATOR" will be executed anyway (see section "PRINTOUTS").

To disable the calculator function, press the C key.

15.3.1 HELP

By pressing the **.HELP** key, it's possible to see the keys list used in the menu.

The key list is automatically. If you want to see the keys list, in manual mode, use the arrow key (F6 ▼ and F7 ▲).

15.4 DISPLAY OF NET WEIGHT WITH SENSITIVITY X 10 (for testing use during calibration)

By pressing at length the **F2** key one will view the net weight with sensitivity times 10 (press again at length the **F2** key to return to the normal visualisation).

NOTES:

- With approved indicator, the visualisation lasts about 5 seconds, after which it's disabled.
- The printout can only be done when the indicator has the standard sensitivity.

15.5 SETTING DATE / TIME

By pressing at length the **F3** key it's possible to quickly access the setting from the date / time of the instrument:

DAY ⇒ **ENTER** ⇒ MONTH ⇒ **ENTER** ⇒ YEAR ⇒ **ENTER** ⇒ HOUR ⇒ **ENTER** ⇒ MINUTES ⇒ **ENTER**.

16. FUNCTIONING WITH ALIBI MEMORY

The alibi memory allows storing the executed weighs or the weights transmitted to the PC.

The stored values can then be recalled by the PC serial line or directly on the indicator's display for a following check.

The data filed with each weigh or upon each weight transmission is:

- Gross weight
- Tare
- Unit of measure
- Number of selected scale

The memorisation of a weigh takes place:

- **Following the reception of a command through the serial line**, See section "REQUEST WEIGHT VALUE WITH WEIGH ID".
- **Upon the printing made with the F5 key or upon totalisation**
By setting the **Setup >> Serial >> Comprn >> Protoc.** parameter on "ALIBI" (**TECH.MAN.REF.**).
Through the selection of the following TX.G.W or TX.N.W parameter, it is possible to choose whether to receive in the response string to the PID command, either the gross or the net weight, along with the tare
It's possible also to transmit the string (weigh/ID) on the PC port, by setting the **Setup >> Serial >> Com pc >> Protoc.** parameter on "ALIBI" (**TECH.MAN.REF.**).
- **If you enabled the parameter OIML R 51 (TECH.MAN.REF)**
Alibi memory protocol is enabled on the printer port, and in addition to weighing, memory, data is saved to the initial and final:
START: 11/09/14 09:31:54, 3.214kg, from 00,000 to 000,000, SN: 12345678.
(date and time, gross weight, target article, identification number, serial number of the instrument)
END: 11/09/14 09:32:28, 2.00000 to 000,003
(date and time, number of weighing, identification number).
NOTE:
In case of printing through the **F5** key, the PID string is transmitted; while after at totalisation is made, the PIDM string is transmitted. See section "STRING FORMAT (WEIGHT/ID)" for the description of the two strings.

The identification of the weigh takes place through the ID code; a code is given to each weigh, allowing finding the weigh in the database.

If the weight can be saved in the alibi, the numeric ID will be substituted with the message "NO".

The ID has the following format:

<Rewriting number > — < Weigh number >

- Rewriting number: number of 5 digits which may go from 0 to 00255; it indicates the number of complete rewritings of the alibi memory.
- Weigh number: number of 6 digits which may go from 0 to 131071; it indicates the weigh number in the current rewriting of the alibi memory

With each storage the weigh number is increased of 000001; when this reaches the value 131071, it restarts from 000000 and the rewriting number increases of 00001.

If the weigh can not be saved in the alibi, the numeric ID will be substituted with the message "NO".

For example:

If the weigh which has been stored is the following:

"PIDST,1, 1.000kg, 1.000kg,00126-131071"

the following will be:

"PIDST,1, 1.000kg, 1.000kg,00127-000000"

NOTE: it's possible to read the last 131071 weighs.

16.1 READING OF THE WEIGHS CARRIED OUT

Through function **418**, combinable with the desired key (<< **F.Keys** >> step, **TECH.MAN.REF.**) it's possible to read a carried out weigh, with weighing cycle disabled (see section "ENABLING / DISABLING THE WEIGHING CYCLE"): first enter the rewriting number of the Alibi memory (rEW.id), confirm with **ENTER**, and then enter the weigh number (id) and press **ENTER**. The ID is accepted only if valid.

If the alibi memory is empty the message "EMPTY" appears on the display for a few instants; if the ID code entered is not valid, the "no id" message appears for a few instants, and then one exits the step.

By entering a valid ID code, the display shows the following data, selectable through the arrow keys ▲ ▼ :

Ch.X in which X is the selected channel number (always 1)

Gross weight value with unit of measure;

Tare weight value with unit of measure;

Net weight value with unit of measure.

Press **C** to exit the reading state of the weighs.

NOTE: It is possible to read the weigh carried out also through the PC serial line (see the "WEIGH READING" serial command in the following section).

16.2 SERIAL COMMANDS FOR MANAGING THE ALIBI MEMORY:

!! IMPORTANT !!

If the serial commands are transmitted in the format:

<ESC> command <STX>

in which: <ESC> is the ASCII decimal 27 character

<STX> is the ASCII decimal 02 character

Also the relative answer will be:

<ESC> string <STX>

16.2.1 REQUEST WEIGHT VALUE WITH WEIGH ID

The command which allows saving the weight in the alibi memory and the transmission is:

<II>PID<CRLF>

< II > = machine code, only if functioning in 485

PID = saving command of the weight data in the alibi memory

CR = ASCII 13 decimal code

LF = ASCII 10 decimal code

If the gross weight is equal or greater than zero and stable, the instrument will save the weight on the belt in the alibi memory.

And the PID string (weight/id) will be transmitted on the PC port; this is described in the following section.

It is also possible to use the command

<II>PIDM<CRLF>

< II > = machine code, only if the 485 is used

PIDM = saving command of the weight data in the alibi memory

CR = ASCII 13 decimal code

LF = ASCII 10 decimal code

Differently than the previous command, this allows to save the last totalised weigh of the instrument in the alibi memory; therefore by transmitting the PIDM command various times after the instrument has totalised a weigh, one will obtain various times the saving of the same weigh until it has been substituted with a new one.

The instrument shows the PIDM (weight/id) string described in the following paragraph.

To avoid the saving of the same weigh various times, it is possible to use the **<II>CIP<CRLF>** command (see the description of the serial commands (**TECH.MAN.REF.**)), and the number of the last stored weigh and the last totalised weigh will be displayed.

By executing a check on the weigh progressive, it is possible to know when a new weigh has been totalised and, by transmitting the PIDM command, and one obtains the saving of the new weight into the alibi memory.

In this way it is possible to store n weighs, avoiding to store the same weigh various times.

NOTE: - the weigh progressive given back by the CIP command, equals to the number of weighs of the lot total
- the command functions only in the weigh cycle

16.2.2 STRING FORMAT (WEIGHT/ID)

The PID and PIDM string contains all the information regarding the executed weigh.

DESCRIPTION OF THE PID STRING:

<ESC>[II]PIDSS,B,LLLLLLLLLLUU,YYTTTTTTTTTUU,(ID | NO)

This string is given with each transmission of the PID commands

DESCRIPTION OF THE PIDM STRING:

[II]PIDMSS,B,LLLLLLLLLLUU,YYTTTTTTTTTUU,(ID | NO)

in which:	[II]	485 address (only in the case of transmission in 485 mode)
	PID OR PIDM	weigh memorisation command
	SS	US unstable weight ST stable weight OL out of range weight (above) UL out of range weight (less)
	,	comma character
	B	number of selected channel
	,	comma character
	LLLLLLLLLL	gross or net weight on 10 digits
	UU	unit of measure
	,	comma character
	YY	2 spaces in case of null or automatic tare, PT in the case of preset tare
	TTTTTTTTTT	tare weight on 10 digits
	UU	unit of measure
	,	comma character
	ID NO	XXXXX-YYYYYY or "NO": weigh not stored in the alibi memory; the gross weight is the negative or unstable result.

16.2.3 WEIGH READING

Command:

[II]ALRDXXXX-YYYYY <CR o CRLF>

in which [II] 485 address (only in the case of 485 transmission mode)
 XXXXX rewriting number, from 0 up to 255.
 - ASCII 045 character
 YYYYY ID code
 <CR o CRLF> terminator, ASCII 13 and ASCII 10 characters

Instrument answer:

[II]B,LLLLLLLLLUU,YYTTTTTTTTTUU <CR o CRLF>

in which: [II] 485 address (only in the case of 485 transmission mode)
 B number of selected channel
 , comma character, ASCII 044
 LLLLLLLLLL gross weight on 10 digits
 UU unit of measure
 , comma character, ASCII 044
 YY 2 spaces in the case of null tare or semi automatic tare, PT in the case of preset tare
 TTTTTTTTTT tare weight on 10 digits
 <CR o CRLF> Terminator, ASCII 13 and ASCII 10 characters

16.2.4 ALIBI MEMORY CANCELLATION (only with non approved instrument)

Command:

[II]ALDL <CR o CRLF>

in which [II] 485 address (only in the case of 485 transmission mode)
ALDL comando di cancellazione dell'alibi memory
CR carriage return (ASCII 13 decimal code)
LF line feed (ASCII 10 decimal code)

Instrument answer:

[II]ALDLOK <CR o CRLF> if the cancellation has been carried out effectively

[II]ALDLNO <CR o CRLF> if the cancellation has not been carried out effectively

DECLARATION OF CONFORMITY

This device conforms to the essential standards and norms relative to the applicable European regulations. The Declaration of Conformity is available in the web site www.diniargeo.com

WARRANTY

The instrument has a TWO-YEARS warranty from the date of delivery. This includes labour and parts free of charge for INSTRUMENTS THAT ARE DELIVERED TO THE SELLER'S MAIN OFFICE and applies only if the breakdown is NOT attributable to the purchaser (for example, due to improper use) and is NOT attributable to the shipping.

If on-site service is requested (or is necessary) for any reason, the technician's travel expenses will be the purchaser's responsibility: travel time and travel expenses as well as board and lodging (if necessary).

If the instrument is shipped through a shipping company, the round-trip shipping expenses are the buyer's responsibility.

This WARRANTY IS VOID if breakdowns result from service performed by unauthorized personnel, if the unit is connected to equipment that was installed by others, or if the connection to the power mains was made incorrectly.

Absolutely NO compensation WILL BE PAID for direct or indirect damage to the purchaser resulting from total or partial loss of functioning of the instruments or systems sold, even if said loss of functioning takes place during the warranty period.

AUTHORIZED SERVICE CENTRE STAMP

