

General information

PWS34020240904

The compression load cell 220 has been designed to operate in difficult and dangerous environments and it is suitable for weighing hoppers, tanks, silos and trucks. The load cell 220 is made of stainless steel and has a maximum capacity of 50 tons. The compression load cell 220 is used in industrial weighing and one of its strengths is the easy installation.



Suggested related products

A highly performing weighing system must be accurate, perfectly calibrated and well maintained. In order to improve the load cell performance and to optimize its functioning, you may need the following products:

Weight Transmitter [DAT 1400](#)

Weight Indicator [MCT 1302](#)

Mounting kits [DE MOUNTING KIT](#)

Tester 1008 [TESTER 1008](#)

Junction Box [CGS4-C](#)

Double Shear Beam Load Cell [DDR](#)

All indicated data may be changed without notice.
All the measures indicated are expressed in millimeters (mm).

Technical specifications

PWS34020240904

Rated Load (RL):	5, 10, 20, 30, 50 t
Combined error:	0.02 % RO
Repeatability:	±0.01 % RO
Creep (30 minutes):	±0.0170% on applied load
Safe overload:	150 % RL
Ultimate overload:	300 % RL
Material:	Stainless steel
Degree of protection:	IP68
Accuracy class:	3000 OIML, NTEP
Compensated Temperature:	-10 ÷ +40 °C
Temperature range:	-30 ÷ +70 °C
Temperature effect on zero balance:	0.0010 % RO/°C
Temperature effect on output:	0.0010 % on output/°C
Rated output RO:	2 mV/V ± 0.1%
Zero balance:	±2 % RO
Insulation resistance:	> 2000 M Ohm
Input resistance:	1065 ±60 Ohm
Output resistance:	1025 ±20 Ohm
Recommended input:	5 ÷ 15 Vdc/ac
Maximum supply voltage:	20 Vdc/ac
Y = Emax/Vmin:	14000
Max number of intervals:	3000
Cable Length:	5m (5t), 10m (10 & 20t), 20m (30 & 50t)

All indicated data may be changed without notice.
All the measures indicated are expressed in millimeters (mm).

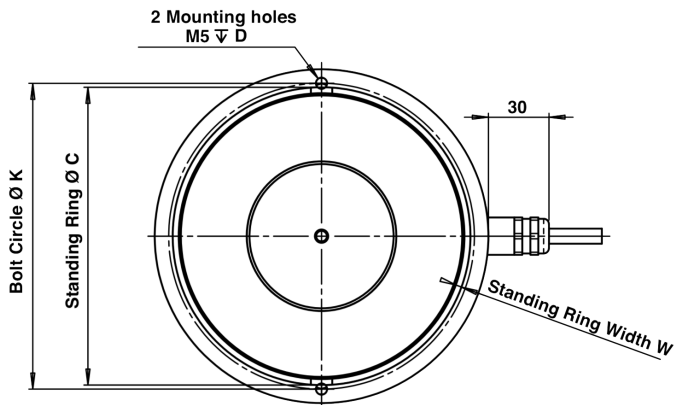
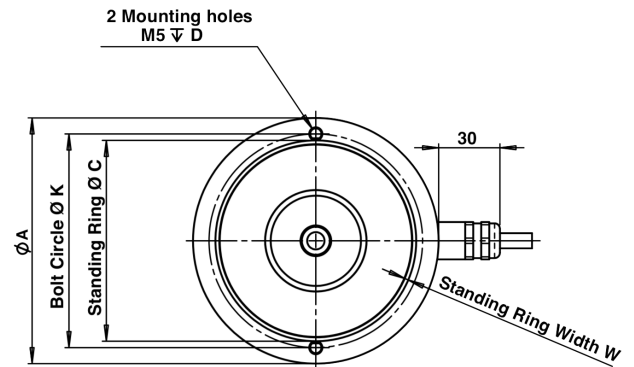
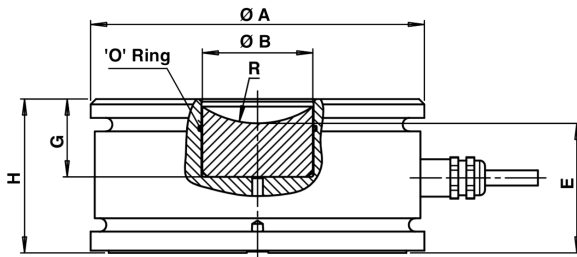
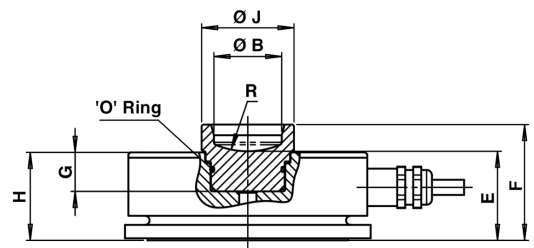
20 t, 30 t, 50 t

5 t, 10 t

CAPACITY	A	B	C	D	E	F	G	H	J	K	W	R
5 t	80	25	71	7	34	43	20	30	35	70	1	31
10 t	92	25	75	6	34	43	15	33	35	80	2	31
20-30 t	110	28	101	8	39	-	26	50	-	102	2	31
50 t	125	41	112	8	49	-	29	58	-	115	2	37

Wiring Schematic Diagram

+VE INPUT	Blue
+VE SENSE	Green
+VE OUTPUT	White
-VE INPUT	Black
-VE SENSE	Grey
-VE OUTPUT	Red

All indicated data may be changed without notice.
All the measures indicated are expressed in millimeters (mm).