

# GI 400 - GI 410

## USER MANUAL

EN

INDUSTRIAL WEIGHING INDICATOR

V.4.5\_29/11/2018



**GI400 LCD**



**GI400 LED**



**GI410 LCD**



**GI410 LED**

# GIROPES

Pol. Empordà Internacional Calle F. Parcela 15-16  
17469 VILAMALLA - (Girona) SPAIN  
T. (34) 972 527 212 - F. (34) 972 527 211

El fabricante se reserva el derecho de modificar sin previo aviso las características de sus productos para introducir mejoras técnicas o cumplir con nuevas regulaciones oficiales./Le constructeur se réserve le droit de modifier les caractéristiques de ses produits en vue d'y apporter des améliorations techniques ou de respecter de nouvelles réglementations./The manufacturer reserves the right to modify the specifications of its products in order to make technical improvements or comply with new regulations.

**EN**

<b>1. MECHANICAL DESCRIPTION</b>	3
1.1 FRONT PANEL	3
1.2 BACK PANEL	5
<b>2. CONNECTION</b>	6
2.1 TEST PHASE	6
2.2 DISPLAY OF THE SERIAL NUMBER	6
2.3 SETTING THE INITIAL ZERO	6
<b>3. EXECUTABLE FUNCTIONS</b>	7
3.1 SETTING THE SCALE TO ZERO	7
3.2 WEIGHT	7
3.3 TARE, CONSECUTIVE TARAS, GROSS-NET	7
3.4 BLOCKING/UNBLOCKING TARE	7
3.5 MANUAL TARE	7
3.6 MEMORIZED TARAS TLU	7
3.7 ACCUMULATION (ONLY WORKS WITH THE PRINT ENABLED PROTOCOL)	7
3.8 WEIGHT TOTALIZATION	8
<b>4. OPERATION MODES (USER MENU)</b>	8
4.1 CALCULATION OF THE AVERAGE UNIT WEIGHT <i>CAL AWU</i>	9
4.2 PIECE COUNTING <i>AWU</i>	9
4.3 CHECKWEIGHER <i>CHECKW</i>	9
4.4 CHECKWEIGHER SIMPLE <i>CCCL 5I</i>	11
4.5 IT SHOWS THE WEIGHT WITH ONE MORE DECIMAL, FOR ACURACY <i>BY 10</i>	11
4.6 ACCUMULATION <i>ACCUMU</i>	12
4.7 SUBTOTAL <i>SUBTOT</i>	12
4.8 TOTALIZATION	12
4.9 CODE <i>TCODE</i>	12
4.10 NUMBER OF TICKET <i>NTIC</i>	13
4.11 WEIGHT MODE <i>WEIGH</i>	13
4.12 DOSAGE <i>DOSIFI</i>	13
4.13 LIMITS <i>LIMIT</i>	14
4.14 ACTIVITY CONTROL <i>Z PEL</i>	15
4.15 DATA DISPLAY <i>MEMORIA DS</i>	15
4.16 MEMORIZED TARAS TLU	16
4.17 ANALOG OUTPUT (ONLY FOR LED DEVICES)	17
4.18 FUNCTION MENU <i>FUNCIO</i>	17
<b>5. SPECIAL FUNCTIONS OF THE NUMERICAL KEYBOARD</b>	17
<b>6. NO METROLOGICAL TECHNICAL MENU</b>	24
6.1.MENU <i>PARAM</i> : COM1, COM2, RS485 Y COM4	25
6.2 ETHERNET MENU	27
6.3 CONFIGURATION MENU	29
6.4 ABT VM	30
6.5 DEFAUL	30
<b>7. PRINTER</b>	30
7.1 TICKET FORMATS GI400	30
<b>8. ERROR MESSAGES</b>	33
<b>9. CONNECTIONS</b>	34
<b>10. DSD MEMORY</b>	39
<b>11. REMOVAL OF ELECTRONIC EQUIPMENT</b>	40
<b>12. OPTIONAL BATTERY</b>	40
<b>13. WARRANTY</b>	40

# 1. MECHANICAL DESCRIPTION

## 1.1 FRONT PANEL

### LED

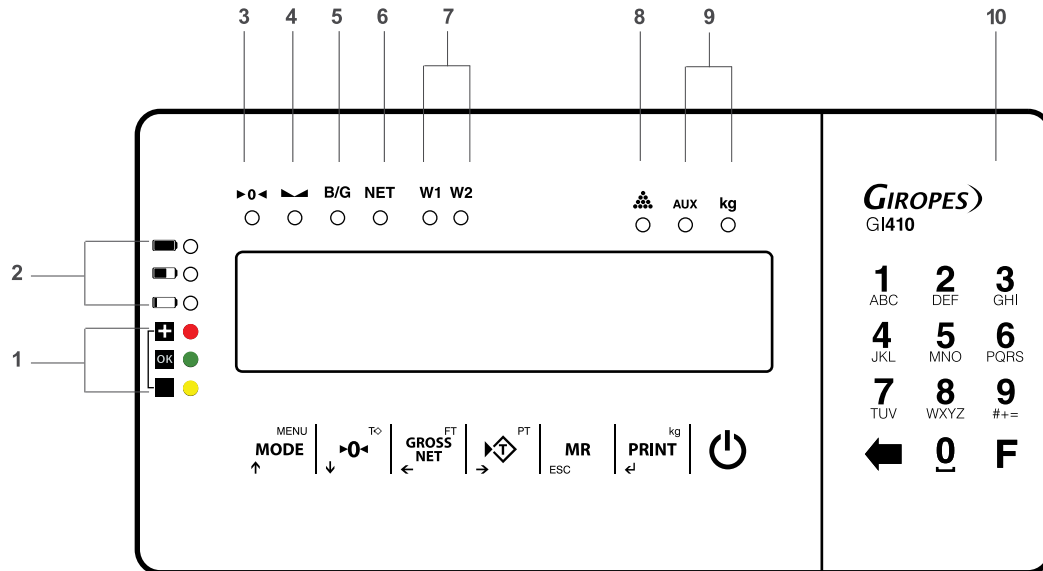



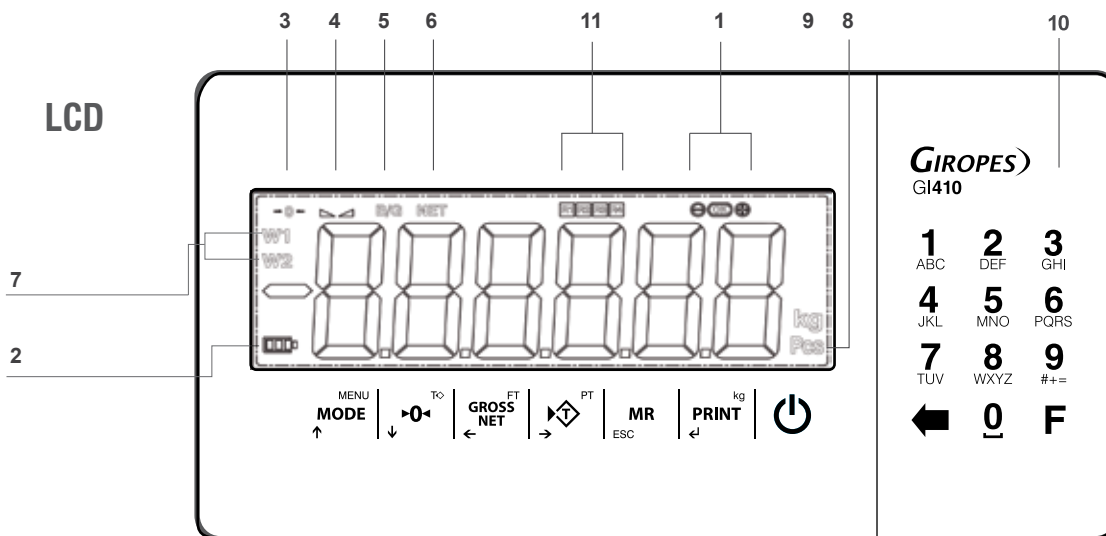



### LCD







### SIGNS

1	Signal of limits (checkweigher)
2	Signal of level of battery (work with battery optional)
3	Signal of zero
4	Signal of steady weight
5	Gross weight
6	Net weight
7	Weighing range
8	Piece counting
9	Units of measure
10	Numerical keyboard (only 410 models)
11	Signal of relays (only for LCD)



**KEYBOARD**

KEY	DEFINITION
	Short Press: Access to User Menus Long Press: Technical Menu
	Short Press: Do zero Long Press: Remove tare
	Short Press: Show Gross/Net Long Press: Set tare
	Short Press: Do the tare Long Press: Introduce tare manually
	Short Press: Weight totalization and total accumulation print Long Press: Exit
	Short Press: Print / Manual shipping weight Long Press: Selector of unit (for lb version only), entry to the functions menu (for other versions).
	Switch on / Switch off



**CURSOR KEYS (Only works in the editing menus)**

	Move editable digit to right side
	Move editable digit to left side
	Increases selected digit
	Decreases selected digit

**TECLAS RECHAZO Y ACEPTAR**

	Erase the current value Hold down to go back.
	Validate the selected value

**NUMERICAL KEYBOARD (ONLY 410 MODELS)**

	Erase key
	Key to change numbers to characters and vice versa. (by pressing enter in the functions menu)

## 1.2 BACK PANEL

**INOX IP54**

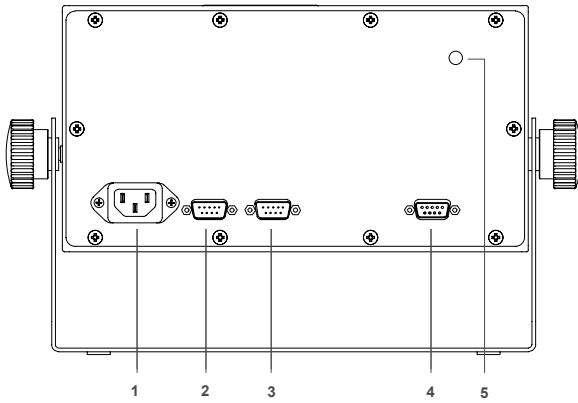

**INOX IP65**

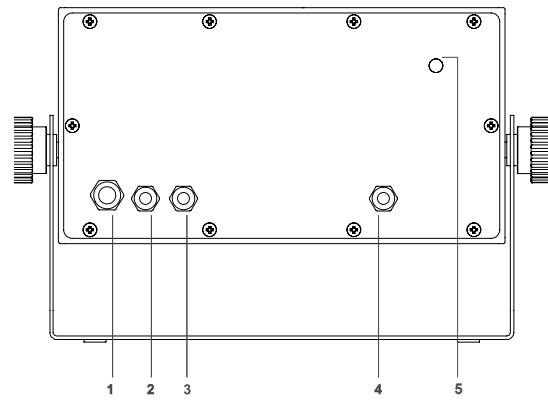

1	<b>Power connector IEC</b>	<b>PG9 for power cable</b>
2	<b>Connector RS232-Com1</b> (SubD 9 male tracks)	<b>PG7 for RS232-COM1</b>
3	<b>Connector RS232-Com2</b> (SubD 9 male tracks)	<b>PG7 for RS232-COM2</b>
4	<b>Connector Load cell</b> (SubD 9 female tracks)	<b>PG7 for load cell cable</b>
5	<b>Calibration switch</b>	<b>Calibration switch</b>

**ABS IP54**

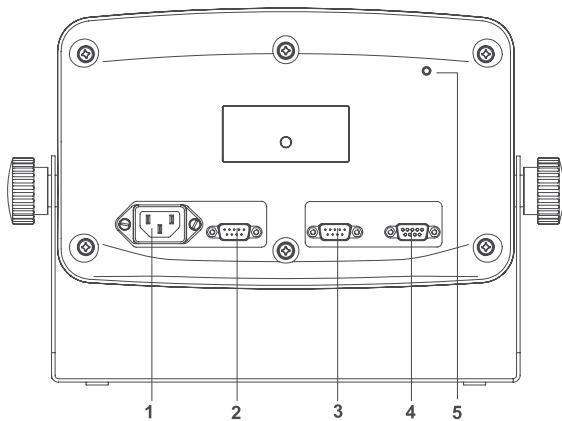

**ABS IP65**

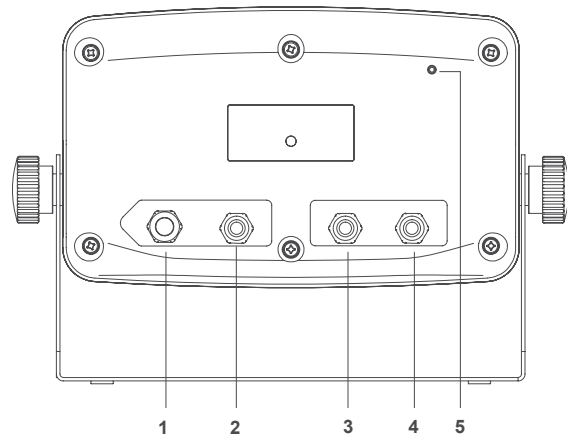

1	<b>Power connector IEC</b>	<b>PG9 for power cable</b>
2	<b>Connector RS232-COM1</b> (SubD 9 male tracks)	<b>PG7 for RS232-COM1</b>
3	<b>Connector RS232-COM2</b> (SubD 9 male tracks)	<b>PG7 for RS232-COM2</b>
4	<b>Connector Load cell</b> (SubD 9 female tracks)	<b>PG7 for load cell cable</b>
5	<b>Calibration switch</b>	<b>Calibration switch</b>

**INOX IP68**

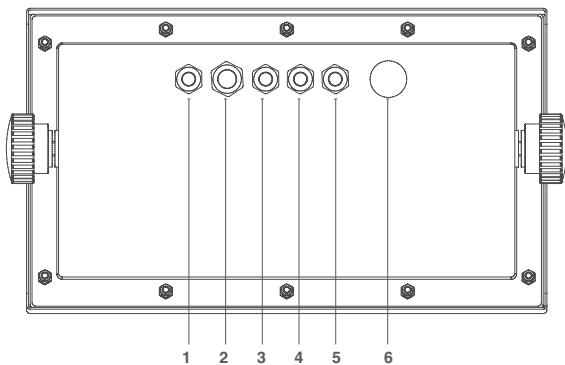

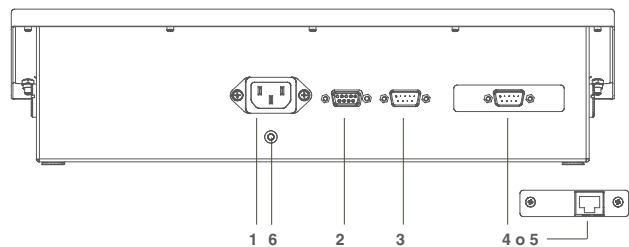

**GI410 PRINT**







1	<b>PG7 for additional port</b>	<b>Power connector IEC</b>
2	<b>PG9 for power cable</b>	<b>Connector Load cell</b> (SubD 9 female tracks)
3	<b>PG7 for load cell cable</b>	<b>Connector RS232-Com1</b> (SubD 9 male tracks)
4	<b>PG7 for RS232-COM1</b>	<b>Connector RS232-Com2</b> (SubD 9 male tracks)
5	<b>PG7 for RS232-COM2</b>	<b>Ethernet Connection</b> (opcional)
6	<b>Pressostatic membrane</b>	<b>Calibration switch</b>

## 2. CONNECTION

Connect the terminal to the platform through a DB9 connector. To switch on the terminal you must press for some seconds the key . To switch off the terminal it is necessary to press for some seconds the key ; but to switch off the terminal completely it can only be done by disconnected the terminal from the electrical connection.

### 2.1 TEST PHASE

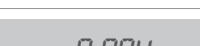
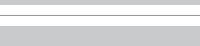
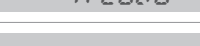
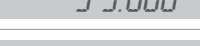
DISPLAY	DESCRIPTION
	In first place it appears the model of the equipment. ( <i>91410</i> =GI410) o ( <i>91411</i> =GI411)
	Next it will show the version of the program
	Then it will appear all LEDs and display segments turned ON. (only LED version)
	After that appears the version of the user's software
	This is followed by the message
	Then displays the value of gravity set
	Then the message number of calibrations, followed by the corresponding value appears.
	Firmware Internal version
	Finally it appears on the screen the weighing software version

### 2.2 DISPLAY OF THE SERIAL NUMBER

If during the phase of test display the user presses the key  the device is going to show the serial number. Which you will also find printed on the back label.



### 2.3 SETTING THE INITIAL ZERO

When connecting the indicator it will start the setting of zero of the scale, to do so the following conditions are necessary:

1. Steady weight (luminous sign of steady weight  on;
2. Weight value not less than -10% of the Max. in relation to the zero of calibration of the scale;
3. Weight value not higher than 10% of the Max. in relation to the zero of calibration of the scale.

During the development of the operation of zero setting the display is going to show the following message:



If the weight is steady but out of the range of zero the display is going to blink for about 1 second more or less.

N.B. The user can't do any operation until the setting of zero has been done

The precision of the setting of zero is inside and not out of the division: 0,25e

## 3. EXECUTABLE FUNCTIONS

### 3.1 SETTING THE SCALE TO ZERO

When the user presses the key  $\blacktriangleright\mathbf{0}\blacktriangleleft$  | assumes the metrological function of weight zeroing, in the modality described below, in reference to the current regulations.

1. Steady weight (the bright sign of steady weight  $\blacktriangleleft\blacktriangleright$  is on);
  2. Weight value not less than -2% of the Max. in relation to the zero of calibration of the scale;
  3. Weight value not higher than 2% of the Max. in relation to the zero of calibration of the scale.
- The brilliant sign  $\blacktriangleright\mathbf{0}\blacktriangleleft$  indicates that the function has been done.

### 3.2 WEIGHT

The device switches on a led of stability when a weight is placed on the platform and when the weight is steady. When the scale is unloaded the device switches on the zero and stability leds.

### 3.3 TARE, SUCCESSIVE TARAS, GROSS-NET

To do a tare the user must press the key  $\blacktriangleright\mathbf{PT}$  |. When this key is pressed the indicator is going to show immediately the net weight, and the Net led switches on.

If the user wants to do another tare, s/he needs to press the key  $\blacktriangleright\mathbf{PT}$  | again.

To know the gross weight (container plus contents) the user must press the key  $\blacktriangleleft\mathbf{GROSS\ NET}$  |. On the display the led Net switches off and the sign of gross weight B/G switches on.

If the user presses this key again  $\blacktriangleleft\mathbf{GROSS\ NET}$  | the device is going to go back to the net weight and the led of Net is going to switch on again.

### 3.4 BLOCKING/UNBLOCKING TARE

If the user wants to block the used tare in the previous section, so that it does not disappear when going through zero, the user must press for some seconds, at least 2, the key tare  $\blacktriangleleft\mathbf{GROSS\ NET}$  |. The value of tare remains blocked. The display informs the operation showing "Tar. Blo".

To unblock the tare the user must keep pressed 2s the key  $\blacktriangleright\mathbf{0}\blacktriangleleft$  |. The display is going to indicate this action by showing the message "Tar. DES" on the screen.

To program the viewer to block the tare automatically, you have to enter the technical menu. Select "Config", and in "Config" in "Autarb". We can put yes or no to the automatic tare block ("Autarb").

### 3.5 MANUAL TARE

The terminal allows the incorporation of a manual tare by pressing during two seconds the key  $\blacktriangleright\mathbf{PT}$  |. The user must use cursor, escape and enter keys for input new tare value. If procedure before is used, tare value will keep locked till you unlock it.

### 3.6 MEMORIZED TARAS TLU

The visor has 5 memorized tares: TLU 1, TLU 2, TLU 3, TLU 4, TLU 5.

Before you can use this function you must edit and activate the desired tare from the User menu/TLU.

The tare value is locked until it is unlocked with the procedure seen in blocking / unblocking tare.

### 3.7 ACCUMULATION (ONLY WORKS WITH PRINT PROTOCOL ACTIVATED)

The user can not use this function without activating it first. To do it, the user must go to the menu "ModE". To go to the menu the user must follow the steps described in **the section number 4** and watch the procedure in the **section 4.6**

Each time that accumulation is done, the message *Acc* appears on screen.

This message disappears after some seconds and it shows again the value of the last weight placed on the platform. If the user has a printer connected to the terminal, the printer prints the weight with selected format.

Note: The accumulation can work manually or automatically

### 3.7.1 SUCCESSIVE MANUAL ACCUMULATIONS

Select the accumulation and printing in manual mode.

Place the weigh on the scale, press **PRINT**<sup>kg</sup> key when stable indication turns on.

If we want to accumulate again, press the key **PRINT**<sup>kg</sup> again.

The indicator will continue memorizing if: the scale has been discharged previously or tare is done or additional weigh has been added.

### 3.7.2 SUCCESSIVE AUTO ACCUMULATIONS

Select the accumulation in automatic mode and enter the number of accumulations to totalize, the printing in stable, stable with zero pass or stable to the discharge.

Place the weigh on the scale, when it takes stability it will accumulate.

The indicator will continue memorizing if: the scale has been discharged previously or tare is done or placed on the platform on additional weight until reaching the number of accumulations programmed or totalized.







## 3.8 WEIGHT TOTALIZATION

If one of accumulation modes is active, once all desired weights had been accumulated and the scale is in zero the user wants to know the total of the weights s/he must press the key **MR**<sub>ESC</sub>. The terminal is going to show the total number of weights and the total net weight.

- If there is a printer defined in the parameters of rs232 and connected, a ticket is going to be printed.

(For ticket copies see menu "Config" / "Print" / "Copy")

## 4. OPERATION MODES (USER MENU)

DISPLAY	DESCRIPTION AND SEQUENCE OF USE		
<b>MODE</b>	<ul style="list-style-type: none"> <li>• The user can access to this menu once by pressing the key <b>MENU</b><sub>MODE</sub> ↑</li> <li>• The display is going to show the message "modE" on the screen and next it will appear the first available function.</li> </ul>		
	- Move to the right side the edition digit.		- Move to the left side the edition digit.
	<ul style="list-style-type: none"> <li>- Inside a menu increases the value of the selected number.</li> <li>- It goes to the previous function.</li> </ul>		<ul style="list-style-type: none"> <li>- Scrolls to the back menu.</li> <li>- Within the menu decreases the selected number</li> </ul>
	<ul style="list-style-type: none"> <li>- Inside a menu, goes back memorizing the value set.</li> <li>- It selects the current function.</li> </ul>		
	<ul style="list-style-type: none"> <li>- If the user keeps this key pressed s/he can exit from the function without memorizing the value set (function ESC).</li> <li>- With short press, returns to zero the current value.</li> </ul>		



## THE AVAILABLE FUNCTIONS ARE:

<i>CAL AUW</i>	CALCULATION OF THE AVERAGE UNIT WEIGHT
<i>AUW</i>	PIECE COUNTING
<i>CHECK</i>	CHECKWEIGHER
<i>CCl Si</i>	CHECKWEIGHER SIMPLE
<i>by 10</i>	IT SHOWS THE WEIGHT WITH ONE MORE DECIMAL FOR MORE ACCURACY
<i>ACCUMU</i>	ACCUMULATION
<i>SubTot</i>	SUBTOTAL
<i>L Code</i>	SET PRODUCT CODE
<i>n t.C</i>	SET TICKET NUMBER
<i>WEIGHT</i>	WEIGHT MODE
<i>dos.F.</i>	DOSAGE (only with additional board 4I/40 (relay) (OPTIONAL)
<i>L.Mt</i>	LIMITS (only with additional board 4I/40 (relay) (OPTIONAL)
<i>2 rEL</i>	ZERO AND WEIGHT (only with additional board (relay) (OPTIONAL)
<i>dSd</i>	FISCAL MEMORY (only with additional board ALIBI) (OPTIONAL)
<i>TLU</i>	MEMORIZED TARAS TLU
<i>AnALog</i>	ANALOG OUTPUTS (Only with analog board (OPTIONAL)
<i>FUnC.o</i>	FUNCTION MODE

### 4.1 CALCULATION OF THE AVERAGE UNIT WEIGHT *CAL AUW*

This function calculates the unit weight of the pieces through the piece counting program. To calculate the average unit weight the user must place a number of known pieces on the platform and then press the key **PRINT<sup>kg</sup>**. The screen of the display is going to show the message *SP.xxxx*. The user must then introduce, using the keys, the number of pieces that make the sample.

To calculate and register the value of the average unit weight the user must press the key **PRINT<sup>kg</sup>**.

The terminal shows- during two seconds- the message “*WE:Un:*” on the screen, followed by the unit weight of the piece. After that, the indicator goes back and shows the number of pieces in the scale.

If the user presses the key **PRINT<sup>kg</sup>** and there is no weight on the platform or the weight is inferior to the necessary to calculate it on the screen, the display is going to show the message “*add*”. This message indicates that more pieces are needed so that the calculation can be done.

### 4.2 PIECE COUNTING *AUW*

This function is used to do the calculation of the pieces loaded on the platform. It does so by taking the programmed average weight (**PMU**). The indicator asks for the **PMU** by showing the message *Px.xxxx*. The user must introduce the value of the unit weight using the cursor keys. Press **PRINT<sup>kg</sup>** key to confirm.

NOTE: The parts count mode remains active until we access the weight mode.

### 4.3 CHECKWEIGHER *CHECK*

This function activates the mode “**CHECK WEIGHER**” or mode goes-not-goes .

The equipment is ready to manage automatically up to **4 zones** through limits of weight for each one of them.

When the user accesses the menu *CHECK* the first parameter s/he must configure is the menu *LArset*: this menu programs the value of the target of weight that the user wants to achieve. Is the central value of OK zone.

After that the user must choose the type of **TARGET** between *TYPE1* and *TYPE2*.

### 4.3.1 TARGET TYPE 1 *T, TYPE 1*

If the user chooses the *T, TYPE 1* it allows to choose the inferior limits and the superior ones with a **percentage** of the TARGET value.

Exemple:

*-PC. 0 10* (We chose how lower limit 10% below the Target)

*PC. 0 10* (We chose how upper limit 10% above the Target)

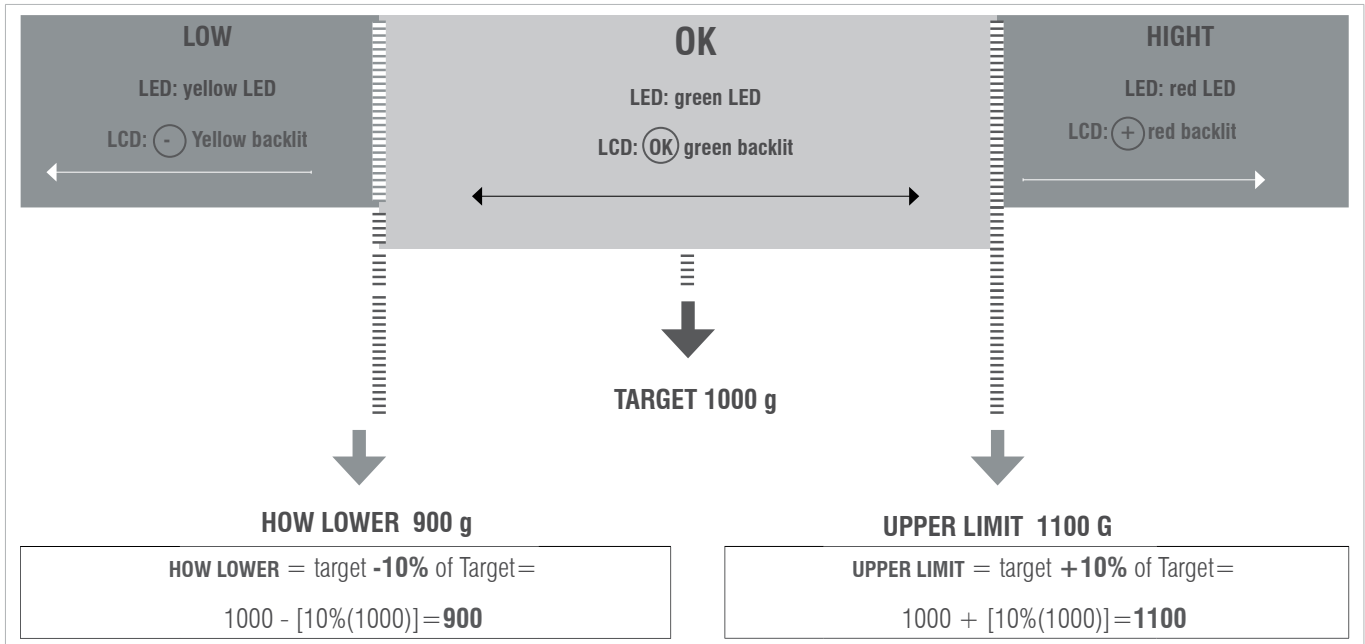

### 4.3.2 TARGET TYPE 2 *T, TYPE 2*

If the user chooses the *T, TYPE 2* it allows to choose the inferior and superior limits directly: *L* (lower) *XXXXX* y *H* (Hight) *XXXXX*

Exemple:

*L 800*

*H 1200*



Once they are configured, the **TARGET** value and the **LIMITS**, the program ask the user to configure the limit of the **ALARM**.

The alarm programs the value wich any value above this one is going to activate the alarm sign, and 3 lights are going to bright.

Finally the user must choose the alarm sound. He can choose between *bEEPT* or *bEEPm*.

### 4.3.3 TYPE BIP *bEEPt*

First we choose the area in which we want the beep to sound, this will occur when entering the selected zone:

*no tAr*: When it's not in the target range.

*LoU*: Below the target range.

*tGrng*: Target range.

*HGH*: Above the target range.

### 4.3.4 BIP MODE *bEEPm*

Then choose the kind of beep: B off/long/short

### 4.3.5 YES/NO ACTIVE

Finally asks us if we want or not to activate the function checkweigher, in the case of not activating it is memorized the configuration that we have chosen previously.

Note: The Checkweigher mode remains active until we access the weight mode

## 4.4 CHECKWEIGHER SIMPLE *CCt S!*

This function activates the "CHECK-WEIGHER SIMPLE" mode or simple pass-not-pass mode. In the case of having indicators with numeric keypad, we can also activate it through F + 9 + 9

The device is prepared to automatically manage up to **3 zones by two weight limits**.

When accessing the *CCt S!* menu the first parameter to be configured is the lower limit. The screen briefly shows InF: and remains showing *L00000*. With the cursor keys or the membrane keyboard, we enter the value of the lower limit and validate with **PRINT** <sup>kg</sup> |

The screen will briefly shows SuP: and remains showing H00000. With the cursor keys or the membrane keypad, we enter the value of the upper limit and validate with **PRINT** <sup>kg</sup> | The screen briefly shows CWS.on and returns to weighing mode with the simple checkweigher function activated

Note: Simple checkweigher mode remains active until we access the WEIGHT mode. In the case of having indicators with numeric keypad, we can also deactivate it by pressing F + 9 + 8.

## 4.5 IT SHOWS THE WEIGHT WITH ONE MORE DECIMAL MORE FOR ACCURACY *by 10*

With the selection of this function the indicator displays one more decimal in the weight.

Once this function is authorized there is an activation of the display. In this situation the less significant number of the display gets activated and it indicates the value per 1/10 of the division of the verification. The decimal moves but the display does not increase a digit.

With the device connected, the display of the data of weight does not respect the metrological indication. It is for this reason that while it is activated all the communication with the series channel is inhibited. The display remains active for a period of approximately **6 seconds**, after this time the terminal, automatically, sets the display in normal weight. Being out of legal metrology, the device keeps extra accuracy till user press **MR** <sub>ESC</sub> | key.

## 4.6 ACCUMULATION *ACCUMU*

This function carries out the process of auto accumulation and ticket printing

TO MAKE THE AUTO-ACCUMULATION FUNCTION WORK, IT IS NECESSARY TO SELECT FIRST THE PROTOCOL PRINT IN COM1 OR COM2, AS IT IS DESCRIBED IN THE SECTION 5 "PARAM" (POINT 6.1)

DISPLAY	STEPS
<div style="background-color: #cccccc; padding: 5px; display: inline-block;">ACCUMUL</div>	<p><b>ACUMUL</b></p> <ul style="list-style-type: none"> <li>Press the key <b>PRINT</b><sup>kg</sup>   the display is going to show one of the legends detailed below.</li> </ul> <div style="display: flex; justify-content: space-around; margin: 10px 0;"> <div style="background-color: #cccccc; padding: 5px; display: inline-block;">ACCOFF</div> <div style="background-color: #cccccc; padding: 5px; display: inline-block;">ACCMAN</div> <div style="background-color: #cccccc; padding: 5px; display: inline-block;">ACCAUT</div> </div> <p>The user must choose them with the keys <b>MODE</b><sup>MENU</sup>   and <b>TO</b><sup>TO</sup>   the selected option is memorized by pressing the key <b>PRINT</b><sup>kg</sup>  .</p>

DESCRIPTION: ACCOFF, ACCAUT AND MANACC, AND CONFIGURATION	
<div style="background-color: #cccccc; padding: 5px; display: inline-block;">ACCOFF</div>	<p><b>ACUMULAR OFF</b></p> <p>The accumulation mode is deactivated</p>
<div style="background-color: #cccccc; padding: 5px; display: inline-block;">ACCAUT</div>	<p><b>AUTO ACCUMULATION</b></p> <p>The accumulation mode is automatic. In the moment of detecting steady weight the device does the accumulation automatically. Once this function is validated the terminal shows on its display the message (nA xxxx). The user must introduce the desired value of the number of accumulations using the following keys:</p> <p>If this value is <b>DIFFERENT FROM 0</b> the system continues with the accumulation of weights until it reaches the prearranged value. If the programmed value is 0, the weights are accumulated until the user decides to press the key <b>MR</b><sub>ESC</sub>   (limit 9999). (Totalitization)</p>
<div style="background-color: #cccccc; padding: 5px; display: inline-block;">ACCMAN</div>	<p><b>ACCUMULATION MANUALLY</b></p> <p>The mode of accumulation is done manually by pressing the key <b>PRINT</b><sup>kg</sup>   The weight must be stable and must change from accumulation before. It will accumulate till the user press <b>MR</b><sub>ESC</sub>  .</p>

## 4.7 SUBTOTAL *SUBTOT*

With this function the user can see the number of accumulated weights and the total weight up to the actual moment. The screen displays first the number of weights and next it automatically shows the total accumulated weight. This function does not entail the elimination of the number of weights and the total of weight.

## 4.8 TOTALITZATION

By pressing **MR**<sub>ESC</sub> | key device shows totalitization value. If one printer mode is selected, the total ticket will be printed. By pressing again **MR**<sub>ESC</sub> key will print a copy. Making a new accumulation after **MR**<sub>ESC</sub> | the memory will be erased.

## 4.9 CODE *TCODE*

This function allows the introduction of a code which is added to the printed ticket. To introduce this code the user must use the keys specified below.

THIS OPTION IS ONLY VALID USING PROTOCOL PRINT WITH THE OPTION PrnF.4 OR PrnF.6 ACTIVATED.

## 4.10 NUMBER OF TICKET *NTIC*

With this function the user can print in the ticket a ticket number which is going to increase automatically at the end of the weight, (number of delivery or number of ticket). Use the cursor keys for change the value and enter escape to exit or memorize..

## 4.11 WEIGHT MODE *WHE:GL*

The user access the normal mode of weighing again.

## 4.12 DOSAGE *dos:F:*

PRECISE PLATE ADDED 4I/4O(relay)

With 4 inputs and 4 outputs. The dosing function is only available when the plate is correctly connected to the display.

The card has four relays with potential-free output up to 0.5A 125VAC or 2A 30VDC. With them you can check remote instruments such as relays, signal lamps and PLC. The card also has four inputs. The 4 inputs are emulated to the keys of the equipment when they are in dosage mode. The dosing function remains active until it is switched off.

The equipment is ready to dose automatically with two different possibilities: 1 product at two speeds or 2 products at one speed, with unload. The device allows the programming, for each product, of the weight of the value of the thickness or product 1, and the value of the weight when the device works at slow speed (that is the value of the smooth) or the value of the product 2. The device can also program a zone of unload where it is defined the value of the dosage (to correct the blocking of the system because there is product left in the weighing zone).

When the equipment starts working it automatically functions with the last formula it has worked with. This allows the device to start again with its daily work.

When the user gets into the menu to program the dosage "*dos:F:*", the following menu is going to appear on the screen:

<i>dos:F:</i>		
<i>reset</i>	YES / NO	yes-no (It sets the process to zero, it also places all the weights to ZERO)
<i>Prod 1w</i>	WEIGHT	thick weight to program or weight of the product 1
<i>Prod 1t</i>	TIME	time of lack of material, if the weight on the screen does not change in this space of time, it activates the relais of alarm.
<i>Prod 2w</i>	WEIGHT	smooth weight to program or weight of the product 2
<i>Prod 2t</i>	TIME	Time of lack of material
<i>2 discw</i>	WEIGHT	Maximum waste weight
<i>2 disc t</i>	TIME	Time of zero, when the zero is activated a time to wait for the falling of the material is also activated
<i>LA:REC</i>	AUTO/NO	Make, or not, auto tare when dosage starts
<i>EnABLE</i>	YES / NO	

### RESET

By selecting YES, all parameters are set zero.

By selecting NO, you can access directly to the parameters to modify them.

### PROD1

It edits the values of the formula for the product 1. If the weight is programmed to 0, the equipment is going to dosify the product 2.

- *w* (Weight): The desired weight for this product is programmed.
- *T* (Timer): Time of lack of material, if the weight on the screen does not vary in this space of time, it is going to activate the alarm (RL4)

### PROD2

It edits the values of the formula for the product 2. If the weight is programmed at 0, the equipment will dosify only the product 1.

- *w* (Weight): The desired weight for this product this product added to product 1 weight is programmed.
- *T* (Timer): Time of lack of material, if the weight on the screen does not vary in this space of time, it is going to activate the relais of alarm. (RL4)

**Z.DISC**

- **W**(weight): This option programs the weight within which the equipment determines that the dosage has been finished, (maximum of possible waste weight that may stay without the alarm ringing)
- **T**(timer): Time waste of material, if the weight on the screen does not vary in this space of time, it is going to activate the relais of alarm (RL4).

**ENABLE**

It exits from the menu of dosage and asks to the user if he wants to get start doing the dosage. To start doing the dosage appears on the display the legend **-- dos 00 --**. The keys will do the functions specified below:

Note:  
The value of timers must be bigger than 000,0 s. for assure the capacity of activate the alarm (RL4). If you want that RL4 (alarm) will never be activated, keep timers to 0s.

ENTRANCE EXT.	KEY INDICATOR	FUNCTION
INPUT 1	<b>PRINT</b> <sup>kg</sup> ↵	START key
INPUT 2	<b>MR</b> ESC	STOP Key
INPUT 3	<b>PT</b> →	RESTART key
INPUT 4	<b>GROSS NET</b> <sup>FT</sup> ←	ABORT key / exits from the DOSI function and goes back to the normal mode. You need to press two times if you use the indicator key.

Note: In the event that the alarm relay (RL4) is activated, press the key **MR**<sub>ESC</sub> and then restart key to continue the process where it was interrupted.  
To dispense a single product, it is necessary to leave the Prod 1W to 0 and set the weight to be dosed in the Prod 2W

**4.13 LIMITS *LIMIT***

**THEY ONLY WORKS WITH THE OPTIONAL RELAYS BOARD**

The equipment is able and thought to manage automatically up to 4 limits through registers of weight for each one of them.

These registers are called

- Start
- Low Limit (Low.L.)
- High Limit (High. L.)
- Alarm

The associated relays is always activated when the weight of the scale is placed between the two limits.

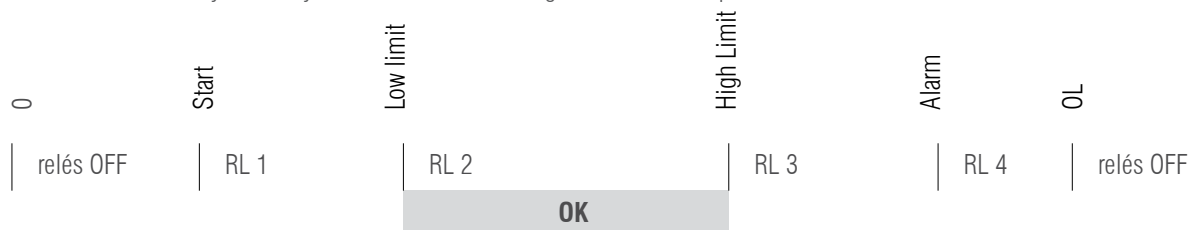

As each relay is in fact a commute circuit, taking the normally closed contacts, the user is going to obtain the inverse sign of the previous figure. When we go to the function of the programming of limits (**LIMIT**), the following menu is going to appear on the screen:

**DISPLAY**

<i>RESET</i>	SI NO	Goes to next parameter without erase the information. It places at 0 all the relays so that it deactivates all of them.
<i>START</i>		It programs the value, every value above this one is going to activate the relays of the L.INF, RELAYS 1 (S xx.xxx)
<i>L.LoU</i>		It programs minimum value, every value below this one is going to activate the relays of the L:INF, RELAYS 1 (L xx.xxx)
<i>OK</i>		This value can not be programmed but it activates the RELAYS 2 whenever the value of the weight is superior to Low L and inferior to the High L
<i>H.GH</i>		It programs the high value, every value above this one is going to activate the relays of the L.SUP, RELAYS 3 (H xx.xxx)
<i>ALARM</i>		it programs the high value, every value above this one is going to activate the relays of alarm, RELAYS 4 (A xx.xxx)
<i>ENABLE</i>		Exit from the menu limits and start to apply them if YES is choosed. If we choose NO exit from the menu and doesn't apply the limits stored on memory.

NOTES: THE FUNCTION OF THE LIMITS IS AUTOMATIC WHEN IT EXITS FROM THE ZERO RANGE. THE LIMIT FUNCION CONTINUES ACTIVATE TILL USER DESACTIVATES IT.

**4.14 ACTIVITY CONTROL *2 rEL***

**REQUIRES ADDITIONAL PLATE 4E/4S(relés)**

It is a variant of the limit function, but involving only two relays, deactivating the first when exiting the value "*Starts*" and the second disengaging once we reach the value "*target*"

<i>2 rEL</i>	rESEt	Select Yes/No to restore values to 0..
	Start (00,000)	Deactivation Value 1st Relay
	target (00,000)	Deactivation Value 2nd Relay
	EnAbLE	Select Yes/No to activate the function

**4.15 DATA VISUALISATION *MEMORIA dSd***

- Accessing to DSD menu (only available if DSD memory is installed) the indicator give access to DSD file to see the weights stored with fiscal memory process.
- The indicator will show the last code inuse, with cursor keys you can input the desired value.
- On last line it shows the current weight.
- Then, operator must input the weighing number about he/she want fet data of brut and tare.
- If data is not stored, it will show an error message, if all is correct, it will show weighing data.

For exit from data menu, keep pressed **MR** ESC key some seconds.

During data viewing "Tx" function from PC will not work.

## 4.16 MEMORIZED TARAS TLU *TLU*

- The visor has 5 memorized tares: TLU 1, TLU 2, TLU 3, TLU 4, TLU 5.
- Before you can use this function you must edit and activate the desired tare from the user menu/TLU
- The tare value is locked until it is unlocked with the procedure seen in lock/unlock Tare.

SELECT: To select the tare that we want to activate, this has to be previously created in the editing section

EDIT: To create the tares up to a maximum of 5.

DELETE: To erase all memorized tares.

## 4.17 ANALOG OUTPUT (ONLY FOR LED DEVICES!) *AnALog*

**ACCESS TO THE MENU IS POSSIBLE ONLY WHEN THE CARD IS CONNECTED**

This card allows the exit of 4-20mA o 0-20mA or 0...+10V o 2...+10V, proportional to the gross weight or the net weight in the scale.

The exit of the current is active and supplies the necessary voltage.

The analog exit is actualized every 50ms and acquires the appropriate value of the weight, converted into in that moment. It is for this reason that if the filter in the weight is decelerated, the analogical exit is also decelerated.

To do the setting of the parameters, the user must access to:

<b>AnALog</b>		
ActiVA		Select Yes/No to turn functionality on or off
4-20mA		Requesting full scale (P. MAX) in kg that will deliver 10V.
0-10V		REQUESTING FULL SCALE (U MAX) IN KG THAT WILL DELIVER 10V.
ADJUST	An Min	Output for negative weight
	An.Zer	Output for zero weight
	An MAX	Departure for the fund allocated scale (U MAX)

We have to activate the **AnALog** function before we start setting

The setup process begins by selecting the operating mode, either 4-20mA or 0-10V depending on the type of output you want. At this point you must specify the full scale **U MAX** which must be equal to or less than the full scale of the scale.

When the back of the scale is confirmed, the device starts the establishment of values of the analog exit, or the values of the digital/analog converter are introduced (comprised between 0 and 65535), for these values it is appropriated a determined value of exit in voltage or current.

In this configuration the keys of the device acquire the following functions:

### *An Min* ( N. xxxxx)

It establishes the minimum value of the analog exit. With this value we adjust so that the equipment gives a value below 4 mA or 0v. It also allows us to program the magnitude of the signal when the value loaded on the platform is below zero, belonging to the condition underload.

### *An.Z Er* ( z. xxxxx)

It establishes the magnitude of the analog exit, be that in current or voltage, when the scale displays the minimum weight, which is going to belong to the Zero of the scale.

### *An MAX* ( M. xxxxx)

It establishes the magnitude of the analog exit, be that in current or voltage, when the scale displays the maximum weight, which is going to belong to the previous FS programmed.

Press **MR** | to access the menú ACTIVA.  
ESC



## EXAMPLE

We are going to take as example a hopper scale with a back of scale of 300kg. Of this scale we only use the range up to 200kg for the exit of 20mA as this is the maximum capacity of the hopper.

In F.S we will introduce 200kg and we will adjust the value of An\_Max so that in the exit we can register 20mA with a multimeter or an automaton. Next we are going to go to the parameter An\_Zer and adjust the value to obtain 4mA in the exit; with this we are going to have a perfect measuring range of 200kg and 16mA. In the parameter An\_Min we are going to introduce a value so that we can read the negatives to up to the 3mA. In the case that the automaton does not allow it, we will adjust the zero to 5mA. The measuring range is going to be of 200kg and 15mA.

## 4.18 FUNCTION MENU *FUnCio*

It is a mode of operation of the user menu. In the next stitch (5. Special functions of the numeric keypad) It is explained, from the operation of the numeric keypad viewfinders, how this mode works.

The diagram of the left side would be common for all the viewers, and in the detail the operation of each section to manage, items of weighing, descriptive items, tares and heavy, navigating the menus with the keys with arrows enter and ESC.

# 5. SPECIAL FUNCTIONS OF THE NUMERICAL KEYBOARD (FOR MODELS WITH KEYBOARD)

You can enter the following menu by pressing and holding the F key. You can also access each function directly using the direct keys.

The numeric keypad allows us to enter the values of the different menus of the viewfinder much faster than with the keys with arrows, which still continue working.

Using the numeric keypad it is possible to memorize a maximum of: 400 items of type of weighing (File1), 400 descriptive items (File2), 10 tares and 1000 weight.

Pr. File 1		Filxxx (Select File 1)	
CODE	XXXXXX		
DESCRI	24 alphanumeric characters		
TARA	TXXXXX		
TYPE	<b>WEIGHT</b>		
	<b>CHECKW</b>	TARGET	TXXXXX
		LOW	LXXXXX
		HIGHT	HXXXXX
		ALARM	AXXXXX
	<b>AUU</b>	PXXXXX	
EANCODE	12 alphanumeric characters (NO FUNCTION)		

DIRECT KEYS	FUNCTION
<b>F</b> + <b>1</b> <sub>ABC</sub> + <b>0</b>	Edit item1 menu
<b>F</b> + <b>1</b> <sub>ABC</sub> + <b>1</b> <sub>ABC</sub>	Activates the item 1
<b>F</b> + <b>1</b> <sub>ABC</sub> + <b>2</b> <sub>DEF</sub>	Deactivates the item 1

<b>Pr. File 2</b>	Filxxx (Select File 2)	
	CODEE	XXXXXX
	DESCRI	24 alphanumeric characters

<b>PrTare</b>	Select tare Number or edit	
	TARAXX	
		TXXXXX

<b>WEIGHT</b>	VISUAL	inUnun	000000 (ticket number)
			IT1num
			IT2num
			W Net
			W Brut
			W Tare
			N Piece
			DATE
			CONFIG
		1 Bip	
		2 Bip+ BUFFULL Message	

DIRECT KEYS	FUNCTION
<b>F</b> + <b>2</b> <sub>DEF</sub> + <b>0</b>	Edit item 2 menu
<b>F</b> + <b>2</b> <sub>DEF</sub> + <b>1</b> <sub>ABC</sub>	Activates the item 2
<b>F</b> + <b>2</b> <sub>DEF</sub> + <b>2</b> <sub>DEF</sub>	Deactivates the item 2

DIRECT KEYS	FUNCTION
<b>F</b> + <b>3</b> <sub>GHI</sub> + <b>0</b>	Edit pretare menu
<b>F</b> + <b>3</b> <sub>GHI</sub> + <b>1</b> <sub>ABC</sub>	Activates tare
<b>F</b> + <b>3</b> <sub>GHI</sub> + <b>2</b> <sub>DEF</sub>	Deactivates tare

DIRECT KEYBOARDS	UNCTION
<b>F</b> + <b>4</b> <sub>JKL</sub> + <b>0</b>	Displays the information of the weights
<b>F</b> + <b>4</b> <sub>JKL</sub> + <b>1</b> <sub>ABC</sub>	Sets the type of warning when filling out the 80% of the weighing buffer. When reaching the 100% the indicator displays the error message OveBuf

TOTAL	
FILE 1	Filxxx
	Net
	Gross
	Tare
	Pieces
	TotWeigh
FILE 2	Filxxx
	Net
	Gross
	Tare
	Pieces
	TotWeigh

DIRECT KEYS	FUNCTION
<b>F</b> + <b>5</b> <sub>MNO</sub> + <b>0</b>	It shows the total of the weighing associated to the item 1
<b>F</b> + <b>5</b> <sub>MNO</sub> + <b>1</b> <sub>ABC</sub>	It shows the totals of the weighing associated to the item2

LIST	
TOTAL E	SinBor ConBor
FILTRO	IT1XXX IT2XXX DATENO/DATESI INICIO FIN
FILE 2	Filxxx
FILE 1	Filxxx

DIRECT KEYS	FUNCTION
<b>F</b> + <b>6</b> <sub>PQRS</sub> + <b>0</b>	Prints the weight total with or without deleting the memory
<b>F</b> + <b>6</b> <sub>PQRS</sub> + <b>1</b> <sub>ABC</sub>	Prints the lists of the filtered weighing, per item 1, item 2 and date
<b>F</b> + <b>6</b> <sub>PQRS</sub> + <b>2</b> <sub>DEF</sub>	Prints the filtered information per item 2
<b>F</b> + <b>6</b> <sub>PQRS</sub> + <b>3</b> <sub>GHI</sub>	Prints the filtered information per item 1

DELATE	
To access the erasing functions it is necessary to enter a password, by default 0000	
FILE1 FiIXX	ALLIT1 TOTIT1
FILE2 FiIXX	ALLIT2 TOTIT2
TARAPR	TARXX
WEIGHT	
GENERATES	NO YES
CAPASS	Change the password

DIRECT KEYS	FUNCTION
<b>F</b> + <b>7</b> <sub>TUV</sub> + <b>0</b>	Deletes item by item the totals of the item1 selected (TOTIT1) or the item1 completely (ALLIT1)
<b>F</b> + <b>7</b> <sub>TUV</sub> + <b>1</b> <sub>ABC</sub>	Deletes item by item the totals of the item2 selected (TOTIT2) or the item2 completely (ALLIT2)
<b>F</b> + <b>7</b> <sub>TUV</sub> + <b>2</b> <sub>DEF</sub>	Deletes a tare scheduled before
<b>F</b> + <b>7</b> <sub>TUV</sub> + <b>3</b> <sub>GHI</sub>	Deletes the stored table of memorized weighing
<b>F</b> + <b>7</b> <sub>TUV</sub> + <b>4</b> <sub>JKL</sub>	General deleting, it deletes all the information in item1, item2, tares and table of weighing.

SELECT
Allows us to activate the memorized items or tares

**CHANGE THE NAME OF THE ITEM1 AND THE ITEM 2**

Enter the technical no metrological menu, inside the menu *CONFIG*, select the option *CODES*.

Choose the items that you need to change the name from *FILE 1*, *FILE2*.

Write the new name of the item in the numerical keyboard.

**EXAMPLE**

In *FILE 1* we write "lorry" and in *FILE2* we write "product", we press the ENTER key during each operation to confirm.

**EDIT THE DATA OF THE ITEM OF THE TYPE OF WEIGHING (ITEM1)**

From normal weighing mode press **F + 7 + 0** (one after the other). Write the number of item 1 we want to edit

Now we introduce the desired data:

DISPLAY	DESCRIPCIÓN
<i>CODE</i>	numerical code of the item
<i>DESCR1</i>	description of the item with a maximum of 24 alphanumerical characters
<i>TARE</i>	value of the tare item
<i>TYPE</i>	to select the type of item WEIGHT, CHECKW or PMU, in the case of Checkweigh and PMU the user must set its parameters
<i>EANCODE</i>	code EAN of the product

Once each one of the parameters are confirmed with the key **PRINT**<sup>kg</sup>, the user must press the key **MR**<sub>ESC</sub>, the screen will display briefly the message *SAVED* and next it will return to the weighing mode. .

**EDIT DATA OF THE DESCRIPTIVE ITEM (ITEM2)**

Once the user is in the normal weighing mode, press the keys **F + 2<sub>DEF</sub> + 0** (one after the other).

The screen is going to display the message PRO (the first three digits of the "product"), followed by *000*.

Write now the number of the item2 that the user wants to edit, for example *PR000 1* and press the key *ENTER*, the screen is going to display the menu described beFore.

Introduce now the desired data:

DISPLAY	DESCRIPTION
<i>CODE</i>	numerical code of the item
<i>DESCR1</i>	description of the item with a maximum of 24 alphanumerical characters.

Once each one of the parameters have been confirmed with the key **MR**<sub>ESC</sub> the user must press the key **MR**<sub>ESC</sub>, the screen will briefly display the message *SAVED* and next I will return to its weighing mode.

**EDIT TARA DATA**

Once the user is in the normal weighing mode of the device, press the keys **F + 3<sub>GHI</sub> + 0** (one after the other).

The screen is going to show the message *TARE00*. Write the number of tare that the user wants to edit, for example *TARE0 1*, and then press the key **PRINT**<sup>kg</sup> the screen is going to display the message *T00.000*, so that the user can introduce the value of tare.

Once it is set, the user must press the key **PRINT**<sup>kg</sup> to confirm the operation, the screen will briefly display the message *SAVED* and it is also going to show again the message *TARE0 1* so that the user can choose another tare to edit. Once the user has edited all the tares needed, the user must press the key **MR**<sub>ESC</sub> during 3 seconds so that the device goes back to its normal weighing mode.

## CONNECT WEIGHING TO ITEMS AND TARE

Each weighing can be connected to one or more items and/or a stored tare, to do so the user first needs to activate them. To do it first introduce the activation code of each one of them.

**EXAMPLE.** Weighing linked to item1, item2 and to a tare.

Choose **F** + **1**<sub>ABC</sub> + **1**<sub>ABC</sub>, the indicator is going to ask for the number of item1, we choose the desired one, *CARROO !* and then press the key **PRINT**<sup>kg</sup>. If that key has a tare connected to it, it is going to be displayed on the screen.

Press the keys **F** + **2**<sub>DEF</sub> + **1**<sub>ABC</sub>, the indicator is going to ask for the number of item2, the user must choose the desired number, *PRODD !* and then press the key **PRINT**<sup>kg</sup>.

Press the keys **F** + **3**<sub>GHI</sub> + **1**<sub>ABC</sub>, the indicator is going to ask for the number of tare, the user must choose the desired number *TO !*, and next the indicator is going to ask if it is needed to activate it, if we press the option *YES*, then we must also press the key **PRINT**<sup>kg</sup>.

Now the user can proceed to do the weighing with an activated mode of accumulation, all the weighing are going to be stored with the associated data until the user selects other data or deactivates by pressing the keys **F** + **1**<sub>ABC</sub> + **2**<sub>DEF</sub>, **F** + **2**<sub>DEF</sub> + **2**<sub>DEF</sub> respectively or **F** + **3**<sub>GHI</sub> + **2**<sub>DEF</sub> when proceeding with a tare.

**NOTA:** If the item1 has a pre tare with a value different to 0 and we also activate a tare by pressing the keys **F** + **3**<sub>GHI</sub> + **1**<sub>ABC</sub>, the last one to activate is the one which becomes effective.

## SEE THE STORED INFORMATION

Via the combination of the keys **F** + **4**<sub>JKL</sub> + **0**, the user can view the information of a stored weighing. To view it the user must only introduce the number of the weighing we are interested in viewing the data.

## CUMULATED TOTAL OF THE ITEM ON THE SCREEN

By using the combination of the keys **F** + **5**<sub>MNO</sub> + **0** ( for item1) or **F** + **5**<sub>MNO</sub> + **1**<sub>ABC</sub> ( for item2), the user can view the information of the cumulated total associated to each item. To view it the user must only introduce the number of the item s/he is interested in viewing the data cumulated total.

## PULL OUT THE TOTAL LIST

Via the combination of the keys **F** + **6**<sub>PQRS</sub> + **0** the user can pull out a total of the weighing no matter if they have been deleted or not from the memory.

### TOTAL LIST

Weighing info	
From:	25/11/15
To:	11/04/16
-----	
Gross total:	4.045 kg
Tare total:	0.800 kg
Net total:	3.245 kg
Pieces total:	000000
Weighing total:	000067
-----	

**LIST FILTERED PER ITEM1, ITEM2 AND DATE**

By using the combination of the keys **F** + **6**<sub>PQRS</sub> + **1**<sub>ABC</sub>, the user can select the number of item2 (*PROD 1*), then the number of the item1 (*PROD 1*) and decided not to filter by date (date NO)

**FILTERED LIST**

```

Report: Weighing
11/04/2016
-----
From:          00/00/00
To:            11/04/16
Product:       001
Lorry:         001
-----
Lorry number:  001
Lorry code:    000122
Lorry:         Mpdj

Product number: 001
Product code:   005508

Product:

Gross weight:   1.000 kg
Tare:           0.200 kg
Net weight:     0.800 kg
Number of pieces: 000000

Lorry Number:   001
Lorry code:     000122
Lorry:         Mpdj

Product number: 001
Product code:   005508
Product:

Gross weight:   1.000 kg
Tare:           0.200 kg
Net weight:     0.800 kg
Number of pieces: 000000

Lorry Number:   001
Lorry code:     000122
Lorry:         Mpdj

Product number: 001
Product code:   005508
Product:
-----
Gross Total:    3.000 kg
Tare Total:     0.200 kg
Net Total:      2.400 kg
Pieces Total:   000000
Weight Total:   000003
-----
    
```

## FILTERED LIST PER ITEM2

In this case we use the keys **F** + **6**<sub>PQRS</sub> + **2**<sub>DEF</sub> and we select the number of item2(PR0001)

### FILTERED LIST PER ITEM2

```
Report: Weighing
11/04/16
-----
Product number:      001
Product code:       005508
Product:
Gross Total:        3.000 kg
Tare Total:         0.200 kg
Net Total:          2.400 kg
Pieces Total:       000000
Weight Total:       000003
-----
```

## FILTERED LIST PER ITEM1

To do so we press the keys **F** + **6**<sub>PQRS</sub> + **3**<sub>GHI</sub> and select the number of item1 (CAM001)

### FILTERED LIST PER ITEM1

```
Report: Lorry
11/04/16
-----
Num camion:         001
Codigo Lorry:      000122
Lorry:             Mpdj
Gross Total:       4.200 kg
Tare Total:        0.800 kg
Net Total:         3.400 kg
Pieces total:      000000
Weight total:      000004
-----
```

**DELETING ÍTEM1**

This operation can be done by using the combination of the keys **F** + **7**<sub>TUV</sub> + **0**, we can delete the information related to an item. To do so the user must select the desired item *CAMOD I* and then choose between *ALLCAM* (it deletes all the information which refers to *CAMOD I* including the item *CAMOD I*) and *TOTCAM* (it deletes the cumulated total referring to *CAMOD I*, without deleting the item *CAMOD I*)

**DELETING ITEM2**

This operation is done using the combination of the keys **F** + **7**<sub>TUV</sub> + **1**<sub>ABC</sub>, we can delete the information related to an item. The user must select the desired item *PRODD I* and then choose between *ALLPRD* (it deletes all the information which refers to *PRODD I* including the item *PRODD I*) and *TOTPRD* (it deletes the total stored referring to *PRODD I*, without deleting the item *PRODD I*)

## 6. NO METROLOGICAL TECHNICAL MENU

In this page the user can find the description of the options of the LIMITED PROGRAMATION. Functions to personalize ONLY the configuration of the NO METROLOGICAL PART (printers, peripherals, analog exits and relays):

- The procedure of the limited programming is done by pressing for a long time the key **MODE**<sup>MENU</sup> ↑
- A pin code must be inserted (4 digit numbers)

The pin of factory is 0000: *P:0000*, press **PRINT**<sup>hg</sup> ↓ for confirm.

Note: The functions availables are the following:

DISPLAY	DESCRIPTION
<i>CAL-PA</i>	(metrological)
<i>CAL O</i>	(metrological)
<i>CAL</i>	(metrological)
<i>GrAUL</i>	(metrological)
<i>Parame</i>	
<i>Conf:9</i>	
<i>Abt VM</i>	
<i>DEFAUL</i>	(metrological)



## 6 Technical menu NO metrologic

### Parameters (Parame)

COM1, COM2, RS485, COM4

Frame

Baud

Protoc

Adres

Delive

### Configuration (Config)

Filter

Date

Time

mV

I.COUNT

Language

CA.PASS

AUTARB

Stand.by (solo para LED)

BLIGHT (only for LCD)

Print

Codes

Power

Repeat

Tcheck (visible only in open calibration)

Decimal (visible only in open calibration)

## 6.1.MENU *PARAME* : COM1, COM2, RS485 Y COM4

Once the Pin is introduced in the mode of limited programming, the display is going to show the following message:

<i>PARAME</i>	In the mode of opened programming, it will show <i>CAL ---PA</i> , press ↓  key till it show <i>PARAME</i> . Press ← for access. With this function you can set NON METROLOGICAL parameters. Use ↑ and ↓ for select the option and ← for access.
<b>COM 1</b>	Setting up port 1 Rs 232 to PC, Printer, etc. ...
<b>COM 2</b>	Setting up port 2 Rs 232 to PC, Printer, ethernet, etc....
<b>RS485</b>	Setting up port 2 on Rs 485 mode. Option only available with RS 485 board.
<b>COM 4</b>	Ethernet port configuration. option is available only via Ethernet board (optional)

### FRAME

The frame allows data communication format.

The possible choices are:

**8n1, 8n2, 8e1, 8o1, 9n1, 9n2, 9e1, 9o1**

### BAUD RATE *baud*

It allows the definition of the speed of communication using the canal of series rs232 com1, com2 and Rs485

The possible choices are:

**300, 600, 1200, 2400, 4800, 9600, 19200, 38400, 57600, 115200** baud.

**PROTOCOLO** *Protocol*

Currently the terminal includes different protocols of communication that can be used through the port of RS-232:

<i>ninGUn</i>	No protocol Enabled	<i>GrAVIT</i>	Protocol – GRAVIT
<i>IMP</i>	Printer Protocols	<i>ALibi</i>	Fiscal Memory Protocol
<i>GIPEs</i>	Giropes Protocols	<i>GIcOnF</i>	Communication protocol with GISCALE
<i>SPI2</i>	Protocol – SIPI II	<i>rAFEL</i>	Protocol - RAFELS
<i>tol dS</i>	Protocol – Toledo DS	<i>bIZErB</i>	Protocol – BIZERBA
<i>ERIC</i>	Protocol - ERIC	<i>SPI O</i>	Protocol – Sipi O.
<i>EPSA</i>	Protocol EPELSA	<i>APLUS</i>	Protocol – Aplus
<i>EPEL A</i>	Protocol EPEL A	<i>CAMP</i>	Protocol – Campesa
<i>EPEL 80</i>	Protocol EPEL80		
<i>M-L</i>	Protocol of METLER		
<i>MobbA3</i>	Protocol Mobba3		
<i>F50 I</i>	Protocol of F501		
<i>SAIE</i>	Protocol SAIE		
<i>MULTiP</i>	Protocol MULTIPUNTO 2000		
<i>SEUr</i>	Protocol SEUR		
<i>LISA</i>	Protocol TISA		
<i>Ud-O</i>	Protocol VDO		
<i>SSCARr</i>	Protocol SENSOCAR		
<i>CSCOMP</i>	Protocol CAS NOVITUS		
<i>Sb-400</i>	Protocol SB-400		
<i>SMART</i>	Protocol Smart		
<i>TXL</i>	Protocol Teacsul		
<i>bILANC</i>	Protocol Bilancai		
<i>br80</i>	Protocol BR80		
<i>br80 i</i>	Protocol BR80i		

**Note: Protocols are explained in the technical Protocols manual**

**ADDRESS** *AddrES*

It allows to adjust the direction of the terminal when the RS485 is used in the protocols that contemplate it (SSCAR and MULTIP).

**SEND** (Mode of transmission) *dELivE*

It allows the configuration of the terminal to send the information to the PC through one of the following modes:

Pc request *PErE*: the terminal sends the chain of information, depending on the protocol, when the order from the PC has been received.

Continuos *CONTin*: the terminal sends the chain of information, depending on the protocol, in a continuous way.

Interval *intERv*: the terminal sends the chain of information, depending on the protocol, when a variation of the weight is obtained.

Stable 0 *StAb 0*: the terminal sends the chain of information, depending on the protocol each time takes stability and the value is different to 0. It needs to pass trough 0 each time.

Repeti *PEPETi*: On this mode the indicator work as a repeater from another GI400 in mode SIPI II continues or interval. Valid for RS485, for RS232 (limit distance: 16m) or ethernet. In RS232 case, use the COM2 in both computers.

ESTODE *ESTOdD*: (Zero to discharge)

Stable *stAbLE*: The terminal sends the data chain, depending on the protocol each time it acquires a stable weight.

Manual *MANUAL*: The terminal sends the data chain, depending on the protocol, to the pressure of the key **PRINT** 

**OPTIONAL RS485**

Only works with RS485 board.

Protocols available on RS485 mode with ID are:

**MULTIPOINT 2000 AND SENSOCAR WITH INDICATOR CAN BE SET AS A REPEATER.**

On indicator with RS485 board board you need to set

PARAMÉ → RS485 → Protocolo SIPI II → Trigger contin.

On indicator with RS485 board wich works as a repeater, you need to set

PARAMÉ → RS485 → Protocolo SIPI II → Trigger romte.

**6.2 ETHERNET MENU ( IT ONLY WORKS WITH AN OPTIONAL ETHERNET BOARD)**

Connect the equipment to the PC using a switch. Enter the IP of the device in the browser **192.168.0.130 (by default)**



Enter the username and password. **(Admin and 1234 by default)**

In the **“Local IP Config”** tab you can change the IP

Versión: v3013 ENG

**GIROPES**  
WIRING SOLUTIONS

**GI ETHERNET**

Estado actual

**Configuración IP**

Modo TCP/UDP

Password

Reiniciar

**Configuración IP**

Tipo IP:

IP estática:  -  -  -

Máscara de subred:  -  -  -

Puerta de enlace:  -  -  -

Servidor DNS:  -  -  -

**Ayuda**

- **Tipo IP:** IP estática o DHCP
- **IP estática:** IP estática del módulo
- **Máscara de subred:** Normalmente (255.255.255.0)
- **Puerta de enlace:** Normalmente es la dirección IP del router

In the **“TCP / UDP mode”** tab you can change the port.

Versión: v3013 ENG

**GIROPES**  
WIRING SOLUTIONS

**GI ETHERNET**

Estado actual

Configuración IP

**Modo TCP/UDP**

Password

Reiniciar

**Base A Parámetros**

Modo trabajo:

Número puerto Local/Remoto:   (0~65535)

PRINT:

Modbus TCP Poll:  Poll Timeout:  (200~9999) ms

Activar red paquete Heartbeat:

Tipo registro:  Ubicación:

**Ayuda**

- **Puerto local** 1~65535. Cuando en modo cliente TCP se selecciona el puerto local a 0, significa que usa un puerto local aleatorio
- **Puerto remoto** 1~65535
- **Paquete tiempo/longitud** El valor por defecto es 0/0, significa mecanismo de paquete automático; se puede modificar por valores distintos de cero

You can change the username and / or password in the **Misc Config**

**If you forget them, you have to open the device and press the RST pads for 5s to reload the factory settings.**

## 6.3 MENU CONFIGURATION

Once the PIN has been introduced, the user is in the mode of restricted programming, move up to **CONFIG**. By using this function the user can program the following NO METROLOGICAL parameters:

<i>FILTER</i>	filters
<i>FEchA</i>	date
<i>dATE</i>	hour
<i>mV</i>	mV of the cell
<i>iCoUnt</i>	Internal accounts
<i>LANG</i>	Language
<i>CH.PASS</i>	Password change
<i>AUTARb</i>	Auto-Lock Tara
<i>STAnBY</i>	autostanby (only for LED version)
<i>bLIGHt</i>	Backlight → (only for LCD version)
<i>Print</i>	Print settings
<i>CoDES</i>	Name of the item1, item2 and tcode
<i>POWEr</i>	Selecting the internal battery type
<i>rEPEAL</i>	Retransmission of plot in repeater mode
<i>TCHECK</i>	(Visible only in open calibration)
<i>dECiMA</i>	(Visible only in open calibration)

**FILTER:** Media weighting filter. Being 1 the most robust 6 the most sensitive.

**DATE:** Select the date in the format DD.MM.AA. Being DD the day, MM the month and AA the year.

**TIME:** Select the time using the format hh.mm.ss. Being hh the time in format 24h, mm the minutes and ss the seconds.

**AUTOSTANBY:** Autostandby time selection. If toFF is set to 00, the Autostandby is disabled. The value entered is the time without weight variation or keystroke that takes to enter standby. It only works when the power comes from the optional battery.

**MILIVOLTS: mV:** It shows the millivolts of the load cell.

**I.COUNT :** Displays the A/D converter data, press to exit.

**LANGUAGE:** Using this menu the user can choose the language in which the tickets are going to be printed and which appears on the display. The languages that are available are: Spanish, French, English, French and Italian.

**PASSWORD CHANGE:** It changes the entrance password to the technical menu, the user must introduce first the current password and then the new one. The password by default is 0000.

**AUTARB:** Using this menu the user can choose if s/he wants to block the tare automatically.

**BACKBLIGHT:** allows to select backlight working mode within Auto, ON, OFF (only for LCD devices).

**PRINT:** Select the type of printer, the auto cutter, the number of line advances at the end of the ticket and the number of copies of the ticket.

**CODES:** It allows to edit the name of the item1, item2 and tcode.

**POWER:** Selection of type of power supply, network, optional battery (3, 7V), optional lithium battery (7.4), this parameter activates the charge indication according to the type of battery.

**REPEAT:** In this menu you can choose whether to re-send or not, the received frame, in the case of using the viewer a repeater of another.

**TCHECK:** (Under development)

**DECIMA:** Allows us to select the decimal separator as comma or point.

## 6.4 ABT VM

Shows the different versions of the program.

## 6.5 DEFAULT

Restore factory defaults.

# 7. PRINTER

The available printers are the following ones:

- IMP05
- IMP27
- IMP28

The working of the printer is described below:

When the user presses the key **PRINT**<sup>kg</sup> the weight is printed, with its number of weighing and its corresponding tare if the mode of transmission is manual (5.1.15).

The user can do successive weights pressing the key **PRINT**<sup>kg</sup>. This process can be done if the system goes first to zero or if a tare is done or if an additional weight is situated on the platform.

Once the user has done all the needed weights, when pressing the key **MR**<sub>ESC</sub> the user will obtain the definitive ticket with the number of weights and the total weight in case that the device has the accumulation option in active mode

If the accumulation mode is automatic, you must choose *shipment* or *Stable 0* or *ESTOPE*. Or *Stable On* the other hand, if the accumulation mode is manual you will have to choose *manual shipment*.

The printed ticket has 40 characters wide.

## 7.1 TICKET FORMATS GI400:

### FORMATS FOR WEIGHT

F. Imp.1

Date: 28/02/2018	Time: 11:08:06
Gross: 654 kg	
Tare: 0 kg	
Net: 654 kg	
_____	

F. Imp.1 (Numeric keypad only)

	Weighing Number: #1	→ 1
	Date: 28/02/2018	Time: 11:15:12
3 ←	T code: 123	→ 2
4 ←	Truck: Cuba	→ 5
6 ←	Grain: Maiz	→ 7
	Gross: 654 kg	
	Tare: 10 kg	
	Net: 644 kg	
_____		

FORMATS COUNTING

F. Imp. 2

Date: 28/02/2018	Time: 11:32:35
PMU:	20000.001953 g
Gross:	654 kg
Tare:	0 kg
Net	654 kg
Units	33 u
_____	

F. Imp. 2 (numeric keypad only)

	Weighing Number: #5	→ 1
	Date: 28/02/2018	Time: 11:15:12
3 ←	T code: 123	→ 2
4 ←	Truck: Volquete	→ 5
6 ←	Grain: Piedras	→ 7
	PMU:	20000.001953 g
	Gross:	652 kg
	Tare:	0 kg
	Net:	652 kg
	Units:	33 u
	_____	

FORMATS CHECKWEIGHER

F. Imp 3

Date: 28/02/2018	Time: 11:37:08
Target Weight:	500 kg
Actual weight:	652 kg
Deviation:	152 kg
_____	

F. Imp 3 (With Item, n° weighing and T Code)

	Weighing Number: #1	→ 1
	Date: 28/02/2018	Time: 11:38:31
3 ←	Tcode: 123	→ 2
4 ←	Truck: Remolque	→ 5
6 ←	Grain: Cebada	→ 7
	Target weight:	100 kg
	Actual weight:	644 kg
	Deviation	544 kg
	_____	

TOTALIZATION (FORMATS 1-2-3)

F. Imp 1-2-3

=====	
TOTAL	
=====	
Date: 28/02/2018	Time: 11:37:08
*****	
Weighing Number:	00002
=====	
Tot Gross:	2614 kg
-----	
Tot Tare:	10 kg
-----	
Tot Net:	2604 kg
=====	

F. Imp 1-2-3 (+ weighing n°)

=====	
TOTAL	
=====	
Date: 28/02/2018	Time: 11:42:10
*****	
Weights:	#00001 - 00001
Number of weights:	00001 → 1
=====	
Tot Gross:	654 kg
-----	
Tot Tare:	10 kg
-----	
Tot Net:	644 kg
=====	









## LEGEND

- 1- The initial value of the editable counter from which each new ticket is added (in the 1-3 format, the weighing number = ticket number. If the ticket number is at zero, it will not appear).
- 2- Fixed editable number (if we have the value to 0, will not appear in the ticket)
- 3- Fixed editable field (if we have the value to 0, will not appear in the ticket).
- 4- Name Item 1 (only with item 1 on)
- 5- Value active record of item 1 (only with item 1 on)
- 6- Name Item 2 (only with item 2 on).
- 7- Value active record of item 2. (Only with Item 2 on).
- 8- Weighing number.
- 9- Header lines (only appear if we have previously edited).
- 10- Code Element 1

## 8. ERROR MESSAGES

DISPLAY	POSSIBLE CAUSES	SOLUTION
 <p>Function of initial zero setting or through a key  in process (blinking message).</p>	<ol style="list-style-type: none"> <li>1. On the scale is weight value superior to the accepted limit of the function</li> <li>2. The weight on the scale is not steady.</li> </ol>	<ol style="list-style-type: none"> <li>1. Unload the scale .</li> <li>2. Wait until the weight is steady.</li> </ol> <p><b>If the anomaly persists you must ask for help to your supplier service centre.</b></p>
 <p><b>OVER LOAD</b></p> <p>The analog sign of the load cell is out of the working range of the A/D chip. This error finishes when the sign reenters the expected range.</p>	<ol style="list-style-type: none"> <li>1. Connector of the load cell not connected..</li> <li>2. Broken cable.</li> <li>3. Broken load cell (due to overload)</li> <li>4. Weight on the top scale at its maximum weight.</li> </ol>	<ol style="list-style-type: none"> <li>1. Control that the connector is correctly connected.</li> <li>2. Control carefully the cable of connection to the load cell and replace it if it defective.</li> <li>3. Control the sign of the cell when unloading. If it is very high you must also replace it.</li> </ol> <p><b>If the anomaly persists you must ask for help to your supplier service centre.</b></p>
 <p><b>ERROR RD/WR EEPROM</b></p>	<ol style="list-style-type: none"> <li>1. Error after an operation of Reading or writing of the EEPROM device</li> </ol>	<p><b>If the anomaly persists you must ask for help to your supplier service centre.</b></p>

## 9. CONNECTIONS

### 9.1 CONNECTION SCHEME IP54

#### 9.1.1 LOAD CELL

The device is completely supplied for the connection of the transducer (load cell). The kit includes:

- 1 male connector to be welded (9 tracks)
- 1 coverage/blocking cable protected

The cable that comes from the transducer or transducers is connected by welding it to the device. The user must be very careful with its quality and the isolation between the conductors and the use of a good alloy of tin. A bad quality product or a product that is not appropriated could damage or alter the correct working of the device..

In the figure 7 it is indicated the topography of the connector; the pins have the following functions:



Fig. 8 - Delta connector 9 tracks for the LOAD CELL(S) ENTRANCE

FUNCTION PIN IN C.D.C.					
Nº PIN	NAME	FUNCTION	NºPIN	NAME	FUNCTION
1	-EXC	(- EXCITATION)	4	+SENSE	(+ TERMINAL OF CORRECTION)
2	-SENSE	(- TERMINAL OF CORRECTION)	5	+EXC	(+ EXCITATION)
3	GND_A	(ANALOG MASS)	6		NOT CONNECTED
7	-OUT	(- TRANSDUCER SIGN)	9		NOT CONNECTED
8	+OUT	(+ TRANSDUCER SIGN)			

If the transducer includes a connection cable with 4 wires plus protection, and not with 6 wires plus protection, the excitation (+) of the device must be connected with SENSE (+) and the excitation (-) with SENSE (-) joining the pin 1 with the pin 2 and the pin 4 with the pin 5.

To reduce the electrical and radio interferences to the minimum, all the connection cables between the device and the transducer must be of a protected type, and all the system must be connected to an optimal earth wire.

The supplying company of the device can supply a type of connection cable that was made on purpose for such conditions. This cable includes a double protection to be welded to the terminals of the shield or on earth.

The following figure shows the different parts involved in the connection of the shields of protection of the cable.

Impedancia mínima 25  $\Omega$

Impedancia máxima 1100  $\Omega$

- 1 External protection** of the cable. It must be pressed in the metal box for cables with terminal moustaches which must be tightened between the two lids of the coverage
- 2 Ending of the internal protection** of the cable. It must be closed in the metal box for cables of the NB. Protection: Do not connect to the pin 3 of the connector
- 3 Coverage protected with conductive material**

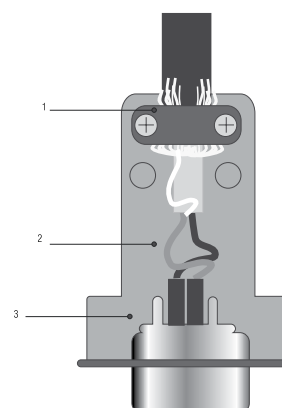

## 9.1.2 INTERFACE SERIE RS-232 COM1 Y COM 2

The instrument has serial outputs type RS232

### Description of the connector pin-out male exit series RS232-com1

n° pin	Description	Direction
2	TX (RS232c - transmitter)	Exit
3	RX (RS232c - receiver)	E
5	GND (signal common)	

## 9.1.3 ADDITIONAL BOARD RS-485 COM2 (DB9)

n° pin	Description
1	EARTH
8	RTx-
9	RTx+

## 9.1.4 ADDITIONAL BOARD 4-20mA/ 0-10V ANALOGUE

n° pin	Description
6	GND
7	$V_{OUT}$
8	$I_{OUT-}$
9	$I_{OUT+}$

## 9.1.5 ADDITIONAL BOARD4E/4S(relés) (DB25)

n° pin	Description
1	RLY1_C
14	RLY1_NO
2	RLY2_C
15	RLY2_NO
3	RLY3_C
16	RLY3_NO
4	RLY4_C
17	RLY4_NO
5	+5V <sub>DC</sub>

n° pin	Description
13	IN1-
25	IN1+
12	IN2-
24	IN2+
11	IN3-
23	IN3+
10	IN4-
22	IN4+
9	+5V <sub>DC</sub>

## 9.2 CONNECTION SCHEME IP65 / IP68

### 9.2.1 LOAD CELL

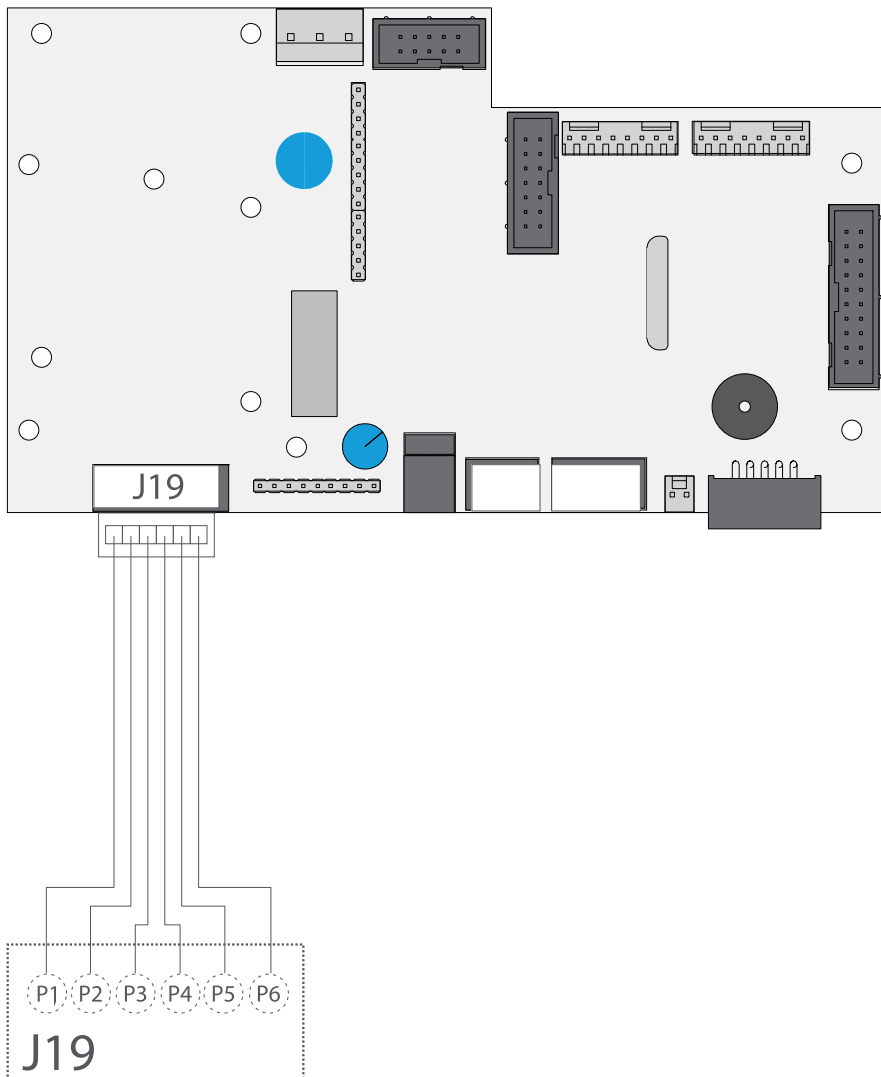

#### CELL CABLE CONNECTOR J19

pin 1	IN+ (out célula)
pin 2	IN- (out célula)
pin 3	SENSE+
pin 4	SENSE-
pin 5	EXC+
pin 6	EXC-

## 9.2.2 SERIAL INTERFACE RS232 COM 1 Y COM 2

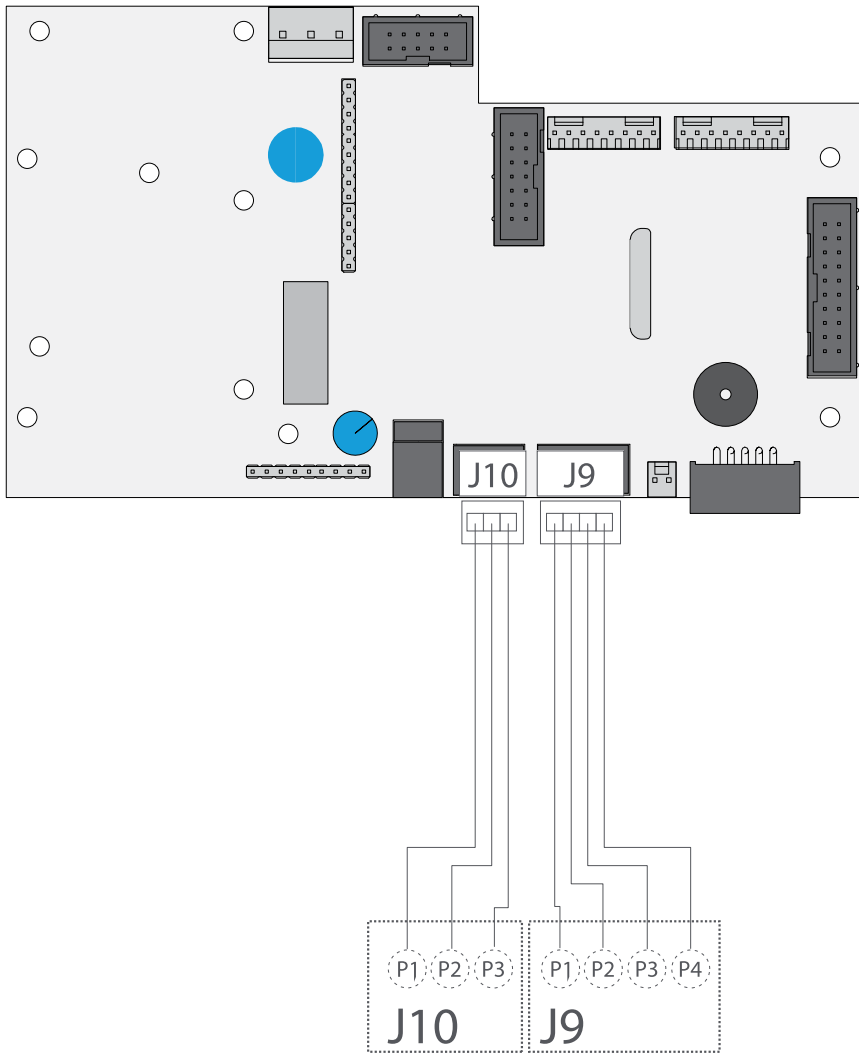

### COM 1 RS232 CONNECTOR J9

pin 1	-
pin 2	RX
pin 3	TX
pin 4	GND

### COM 2 RS232 CONNECTOR J10

pin 1	RX
pin 2	TX
pin 3	GND

**9.2.3 OPTIONAL SCHEME RS485**

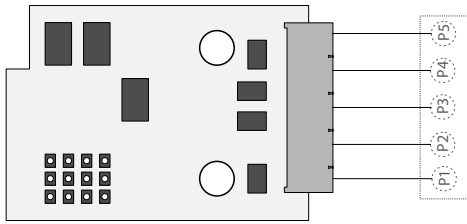

pin 1	RTX +
pin 2	RTX -
pin 5	EARTH

**9.2.4 OPTIONAL SCHEME 4-20MA/ 0-10V ANALOGIC (DB9)**

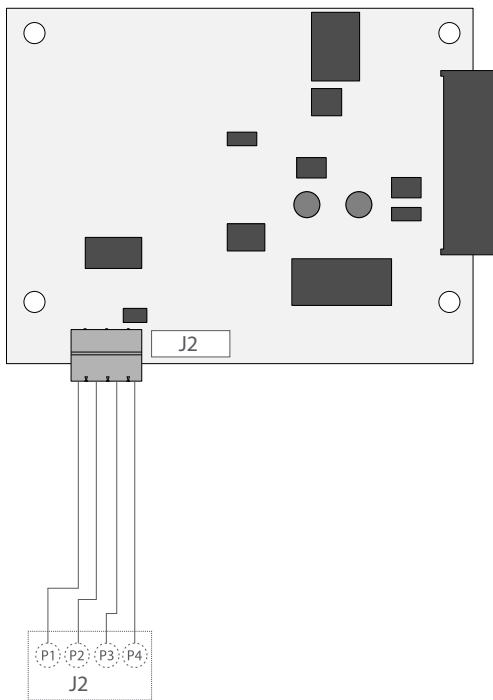

**CONNECTOR J2**

pin 1	$I_{OUT} +$
pin 2	$I_{OUT} -$
pin 3	$V_{OUT} +$
pin 4	$V_{OUT} - (GND)$

**9.2.5 OPTIONAL SCHEME 4I/4O (RELÉS)**

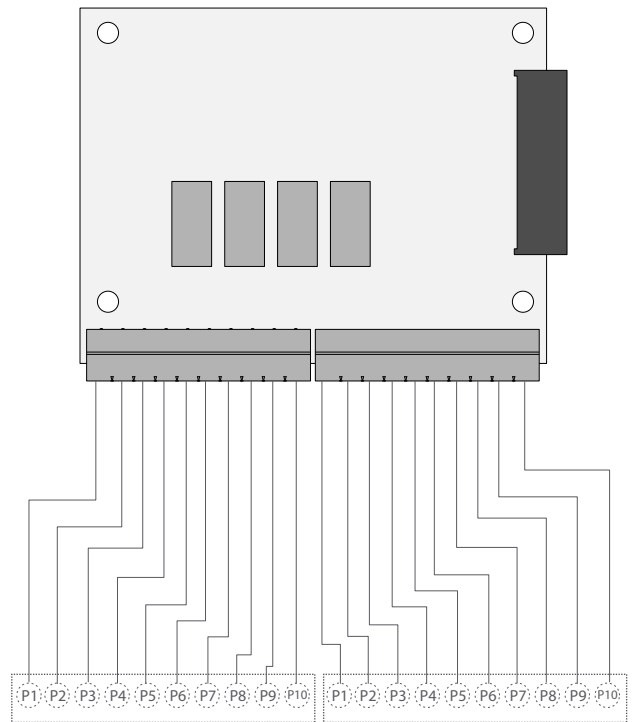

pin 1	RLY1_C	pin 1	IN1 -
pin 2	RLY1_NO	pin 2	IN1 +
pin 3	RLY2_C	pin 3	IN2 -
pin 4	RLY2_NO	pin 4	IN2 +
pin 5	RLY3_C	pin 5	IN3 -
pin 6	RLY3_NO	pin 6	IN3 +
pin 7	RLY4_C	pin 7	IN4 -
pin 8	RLY4_NO	pin 8	IN34 +
pin 9	+ 5V <sub>DC</sub>	pin 9	+ 5V <sub>DC</sub>
pin 10	GND	pin 10	GND

## 10. DSD MEMORY IP54 / IP65 / IP68

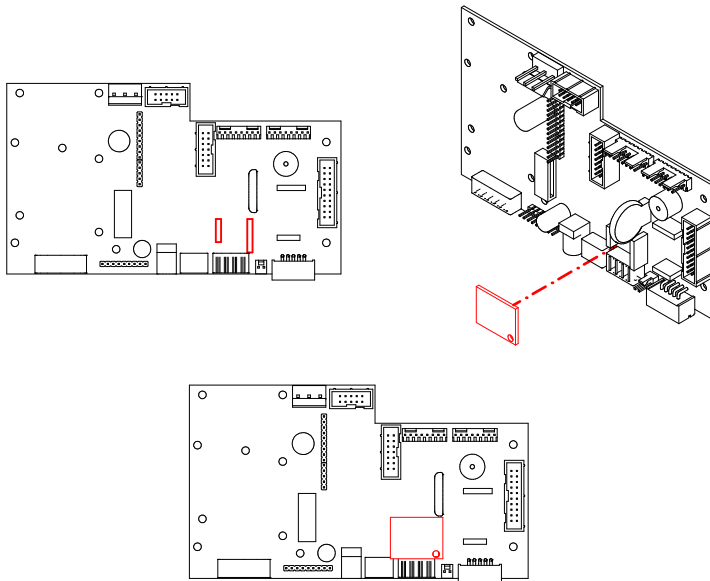

It is possible to increase the operation of the weight indicator with the additional plate that performs the function of FISCAL MEMORY; It consisted in filing all the weight values transmitted to a computer for a subsequent processing or integration of the data transmitted by the COM serial channel.

Each archived value is associated with an ID code. The stored value can be consulted in the display of the indicator using the ID. (As control with respect to data printed by the PC).

The fiscal memory can store a maximum of 400 000 weighings, after which, it re-writes on the heavy number 0.

With the serial command "PID" or via the key **PRINT**<sup>kg</sup>, the scale number, the gross weight, the tare weight and an ID that unequivocally identifies the weighing is sent, only in case the platform is **stable and the gross weight is not negative**.

The ID have the following format:

**<Unique code number>, <Number of weight>**

Unique code number: 5 digit number ranging from 0 to 99.999, indicative number of complete single code of fiscal memory.

The fiscal memory can store a maximum of 400 000 weights, after which the weighing number starts again by 00000 and the unique code number is incremented one at a time.

The weighing relative to an ID can be verified only if:

Has a unique code number equal to the current one in the fiscal memory and a weighing number less than or equal to the last value received with the "PID2" command.

## 11. REMOVAL OF ELECTRONIC EQUIPMENT



### For the European Union customers:

All the products that have arrived to its ending in their life cycle must be restored to their builder so that they can be recycled. For further information about the restoring modalities, please contact your supplier.

## 12. OPTIONAL BATTERY

The GI410 has three battery indications (by LEDS on LED model).



HIGH battery level (100% - 70%)



MEDIUM battery level (70% - 40%)



LOW battery level ( - 40%). You must connect the equipment to a power outlet.



During the charge (only LCD model)

During the charge (only LED model). Turn on high level and low level at the same time.

## 13. WARRANTY

This viewer is guaranteed against defects in materials or workmanship for a period of 1 year from the date of delivery.

Giropès, will be responsible for repairing the viewer during this period.

This warranty does not cover damage caused by misuse or overloading.

The warranty does not cover shipping costs (freight) necessary to repair the balance.



## NOTES

## NOTES

## NOTES

***GIROPES***)

Pol. Empordà Internacional Calle F. Parcela 15-16  
17469 VILAMALLA - (Girona) SPAIN  
T. (34) 972 527 212 - F. (34) 972 527 211