

DGT4

Digital weight transmitter with 4 channels

USER MANUAL

ENGLISH

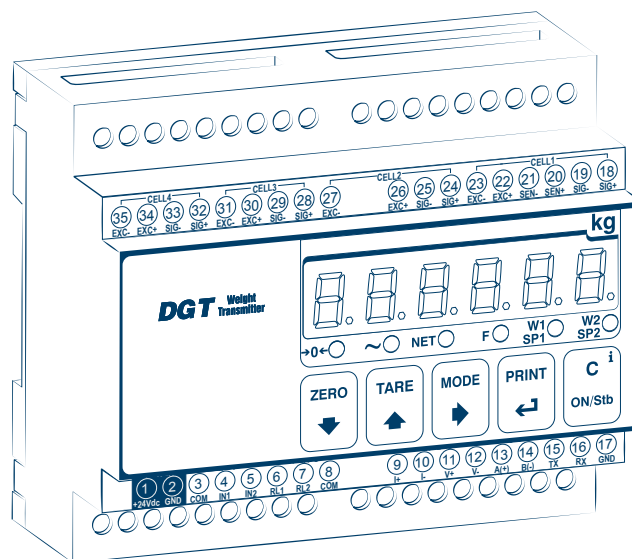

For DGT4 with firmware release minimum 08.03

Introduction	7
Transmitter installation	8
Installation requirements	8
Electrical precautions	9
Earthing of the system	11
Technical features	14
Load cell installation	15
Wiring diagrams	16
DGT4	16
DGT4AN	17
DGT4PB	18
DGT4ETHIP, DGT4ETHCAT, DGT4PRONET, DGT4MODTCP	19
DGT4CANOP	20
DGT4DEVNET	21
Display and function of the keys	22
Quick menu	22
Advanced programming menu	23
Access to the menu and saving the changes	23
Function of the keys in the menu	23
Block diagram of the menu	24
Mode of use of the DGT4	26
On / Off	27
Theoretical calibration	28
Dependent channels	28
Independent channels / transm	29
Calibration with sample weights	30
Dependent channels (with digital equalisation)	30
Independent channels / transm	32
Equalisation	34

Manual calibration	35
Manual calibration	35
Quick zero calibration (pre-tare zeroing)	35
Filter and stability	36
Filter adjustment	36
Stability detection sensitivity	36
Display updating frequency	37
Gravity	37
Zeroing parameters	38
Auto-zeroing on ignition	38
Maximum percentage of manual zeroing	38
Zero tracking	38
Restoring zero	39
Semi-automatic zeroing	39
Tare functions and parameters	40
Tare mode	40
Semi-automatic tare	40
Predetermined tare	40
Clearing the tare	40
Alibi memory	41
Enabling the alibi memory	41
Saving a weighing operation in the alibi memory	41
Reading the alibi memory	42
Initialising the alibi memory	42
Use functions	43
High resolution	43
Peak detection	43
Converting units of measurement	43
Alibi memory	43
No function	43
Input configuration	44
Output configuration	45

Analog output configuration	46
Serial communication configuration	48
Selection of the PC serial port	48
Configuration of the printer port (COM.PRN)	49
Transmission mode	49
Baud rate, parity, data bits, stop bits	50
Printer power on mode	50
CTS signal	50
Print language	50
Reactivation of printing	51
Configuration of the PC port (COM.PC)	51
Transmission mode	51
Baud rate, parity, data bits, stop bits	52
Communication protocols	53
Standard string	53
Extended string	53
Multi-scale string	54
Serial commands	55
Diagnostics	58
Cells / converter test	58
Firmware release	58
Serial number	58
Display	58
Keypad	58
Serial ports	59
CTS signal	59
Inputs	59
Outputs	59
Analog output (mod. DGT4XAN)	59
Programming the Setpoints	59
Restoring factory settings	60
Date and time setting	60
Alarms	61



Introduction

Dear Customer,
Thank you for purchasing a DINI ARGEO product.

This manual contains all the instructions for a correct installation and commissioning of the DGT4 4-channel digital weight transmitter. While thanking you for purchasing this product, we would like to draw your attention to some aspects of this manual.

This booklet provides useful information for the correct operation and maintenance of the scale to which it refers; it is therefore essential to pay the greatest attention to all those paragraphs that illustrate the simplest and safest way to operate.

It is recommended that you carefully follow the instructions for programming the weight transmitter; performing actions not indicated in this manual could compromise the proper functioning of the scale.

The utmost care has been taken in compiling this manual, but reports of any inaccuracies are always welcome.

The instrument is covered by warranty and **MUST NOT BE TAMPERED WITH BY THE USER** under any circumstances. Any attempt at repair or modification may expose the user to the danger of electric shock and voids any warranty conditions, relieving the Manufacturer from all liability.

Any problem with the product must be reported to the manufacturer or to the retailer where it was purchased. In any case, always **TURN OFF THE POWER SUPPLY** before any installation or repair operation.



Installation requirements

Observe the following conditions for correct installation of the transmitter and of the load receiver:

- Flat, level support surface.
- Stability and absence of vibrations.
- Absence of aggressive dusts and vapours.
- Absence of draughts.
- Make sure that the platform is levelled or that the load cells are evenly supported.
- Moderate temperature and humidity (15°C - 30°C and 40% - 70%).
- Do not install in an environment where there is a risk of explosion.
- All transmitter connections must be made in accordance with applicable regulations in the area and environment of installation. Observe the electrical precautions listed in the section “**Electrical precautions**”.
- Ensure that it is correctly earthed, see the relevant section “**Earthing of the system**”.
- Do not perform welding when the load cells have already been installed.
- If necessary, use watertight sheaths and fittings to protect the load cell cables.
- Any junction boxes must be watertight.
- Anything not expressly described in this manual constitutes improper use of the equipment.

Electrical precautions

- Use a regulated mains supply within $\pm 10\%$ of the rated voltage.
- The electrical protections (*fuses, etc.*) are the responsibility of the installer.
- Observe the recommended minimum distances between cables of different categories (**see table on page 10**).
- The following cables must comply with the maximum permissible lengths (**see table on page 10**), they must be shielded and must be inserted alone in metal conduits or pipes:
 - the load cell extension cables;
 - the signal amplifier cables;
 - the cables for connecting the serial ports;
 - the analog output cables.
- The cell or amplifier cables must have an independent input in the electrical panel. They must be connected (if possible) directly to the terminal block of the transmitter without passing through the conduit with other cables.
- Fit "RC" filters:
 - on the contactor coils;
 - on the solenoid valve coils;
 - on all devices that produce electrical interference.
- If condensation can occur inside the weight transmitter, it is advisable to keep the equipment powered at all times.
- Connections to load cells and any external device must be as short as possible.
- The cable ends (connectors, leads, terminals, etc.) must be installed correctly; the cable shielding must be kept intact until close to the connection point.
- If the transmitter is placed inside an electrical panel, a shielded cable must also be used for the power supply.

RECOMMENDED DISTANCES AND CABLE CLASSIFICATION

	Category I	Category II	Category III	Category IV
Distance				
Classification	<p>Fieldbus, LAN network (PROFIBUS, Ethernet, Devicenet...).</p> <p>Shielded data cables (RS232...).</p> <p>Shielded cables for analog digital signals < 25 V (sensors, load cells...).</p> <p>Low voltage power supply cables (< 60 V).</p> <p>Coaxial cables.</p>	<p>DC supply cables with voltage > 60 V and < 400 V.</p> <p>AC supply cables with voltage > 25 V and < 400 V.</p>	<p>Power supply cables with voltage > 400 V.</p> <p>Telephone cables.</p>	<p>Any cable subject to lightning danger.</p>

MAXIMUM ALLOWED LENGTHS

Load cell	RS232	RS485	Analog output
<p>50 metres with 6 x 0.25 mm² cable;</p> <p>100 metres with 6 x 0.5 mm² cable.</p>	<p>15 m with baud rate up to 19200.</p>	<p>1200 m with shielded 2 x 24 AWG twisted pair with outer braid + aluminium strip.</p>	<p>CURRENT: 100 metres with 2 x 0.25 mm² cable; 150 metres with 2 x 0.5 mm² cable; 300 metres with 2 x 1 mm² cable.</p> <p>VOLTAGE: 50 metres with 2 x 0.25 mm² cable; 75 metres with 2 x 0.5 mm² cable; 150 metres with 2 x 1 mm² cable.</p>

Earthing of the system

For correct earthing and optimal system operation, the load cells, junction box, if any, and weighing structure must be earthed.

LOAD CELLS AND JUNCTION BOX

The connection must be made by connecting the earth cables to the earth bar (cables that must have a cross-section of at least 16 mm²); finally, connect the earth bar to the earth post with a cable having a cross-section of at least 50 mm².

EXAMPLES:

- If the load cells are connected to the transmitter through a junction box, the cable shield from the transmitter and the cell cable shields must be connected to the earth socket of the junction box (refer to the junction box manual) and the junction box must be earthed using a copper cable with a cross-section of not less than 16 mm².
- If the load cells are connected directly to the transmitter (without using the junction box), the cell cable shields must be connected to the earthing point (or earth bar).
- If the weighing system involves large and/or outdoor structures (weighbridges, silos, etc.) and the distance between the junction box and the weight transmitter is greater than 10 m, connect the cell cable shields to the earth socket in the junction box.

WEIGHING STRUCTURE

Earth the weighing structure and/or any unconnected structures (e.g. silos that release material onto the weighing structure) using cables with a cross-section of not less than 16 mm².

Also connect the upper part with the lower part of each cell by means of a copper braid with a cross-section not less than 16 mm² (refer to the earthing examples on page 12 and page 13).

SERIAL CABLES AND CONNECTED INSTRUMENTS

Connect the serial cable shield to the earthing point (or earth bar) inside the panel. To avoid any undesired effects, the earth reference of the connection cable, power supply and transmitter must be at the same potential.



GENERAL NOTES:

- All earth cables must be of suitable length, so as to obtain an overall resistance of the earthing system of less than 1 Ω.
- If the weighing system involves large and/or outdoor structures (weighbridges, silos, etc.):
 - the earth connection must be made by connecting the earth cables to an earth bar and the earth bar to the earth post with a cable having a cross-section of not less than 50 mm²;
 - the thickness of the cables must be greater (50 mm² instead of 16 mm² and 100 mm² instead of 50 mm²), because the voltages at stake are greater (e.g. lightning);
 - the earth post must be placed at a distance of at least 10 m from the structure.
- If the load receiver is more than 10 m from the transmitter, we recommend using the SENSE line and load cells equipped with a (SENSE) compensation circuit.

EXAMPLE OF EARTHING OF A WEIGHBRIDGE

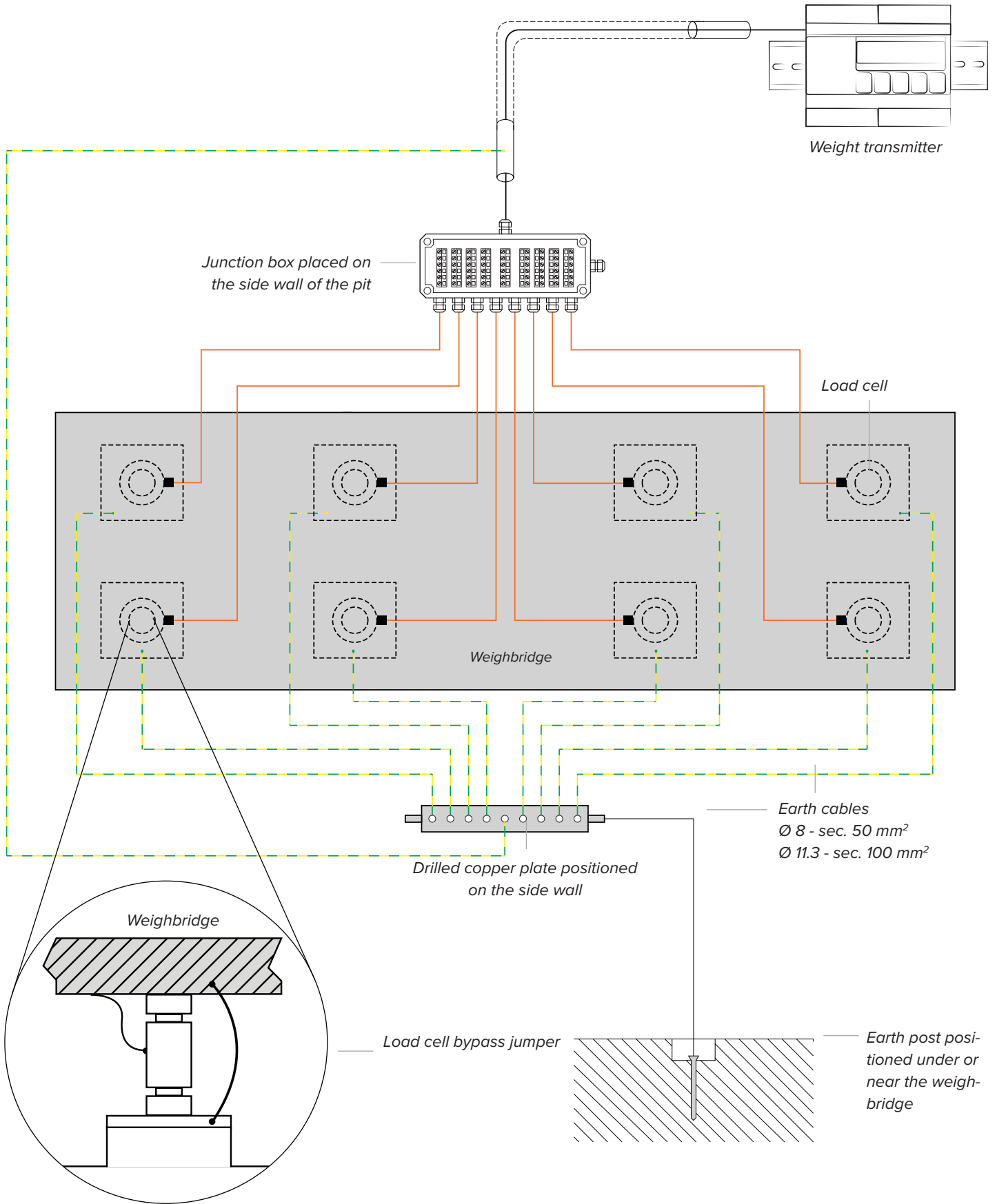

EXAMPLE OF EARTHING OF A SILO

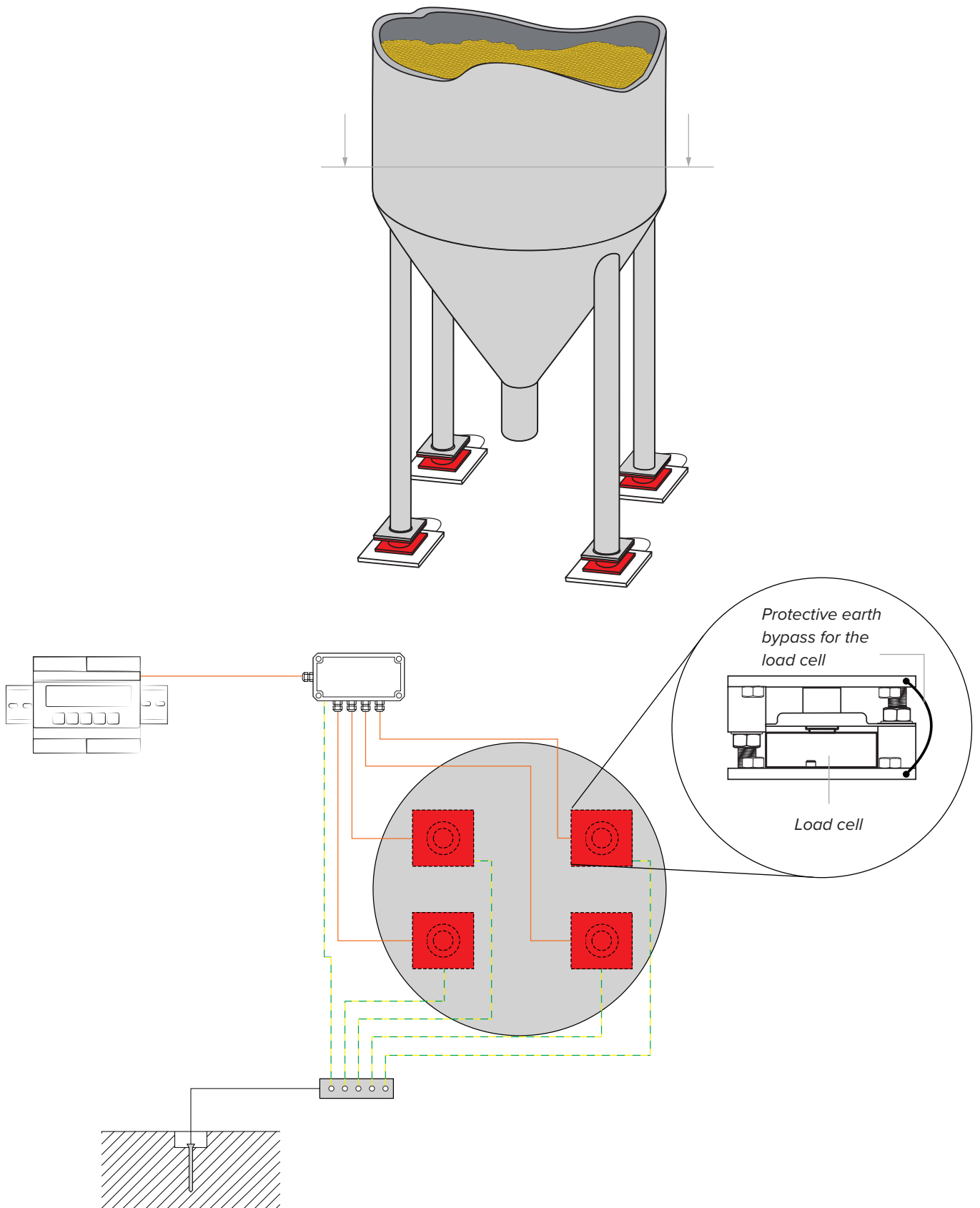

Technical features

POWER SUPPLY	12 - 24 Vdc LPS or with class 2 power supply.
MAXIMUM ABSORPTION (without load cells)	DGT4: 100 mA at 12 V / 70 mA at 24 V (2 W); DGT4AN: 185 mA at 12 V / 90 mA at 24 V (2.5 W); DGT4 with fieldbus: 410 mA at 12 V; 220 mA at 24 V (5 W).
OPERATING TEMPERATURE	From -15°C to +40°C.
DISPLAY DIVISIONS	10000e, 2 x 3000e for legal weighing, expandable up to 800,000 for internal use (with a minimum cell signal of 1.6 mV/V).
SAMPLING SPEED	Up to 400 conv. / sec.
MINIMUM VOLTAGE PER DIVISION	0.3 μ V (<i>approved instrument</i>); 0.03 μ V (<i>non-approved instrument</i>).
COUNTING RESOLUTION	1,500,000 points (with input signal 3 mV/V).
DISPLAY	6 digits, h 13 mm.
SIGNALS	6 status indicator LED lights.
KEYPAD	5 keys.
TARE FUNCTION	Subtraction possible over the entire range.
LOAD CELL POWER SUPPLY	5 Vdc \pm 5%, 120 mA (max 8 cells of 350 Ω).
LOAD CELL CONNECTION	6 wires (CELL1) with sense, 4 wires (CELLS 2, 3, 4).
CONNECTABLE CELLS	Up to 8 350 Ω cells.
CASE	Made of plastic, suitable for DIN rail or wall mounting.
SERIAL OUTPUTS	1 RS485 bidirectional port; 1 configurable RS232 bidirectional port for connection to printer; 1 PROFIBUS port (DGT4PB* version); 2 ETHERNET ports (versions DGT4ETHIP*, DGT4MODTCP*, DGT4ETHCAT*, DGT4PR-ONET*); 1 CANOPEN port (DGT4CANOP* version); 1 DEVICENET port (DGT4DEVNET* version). * <i>Fieldbus models are not equipped with port 485.</i>
OUTPUTS / INPUTS	2 fotomosfet outputs NO or NC, configurable as programmable weight thresholds: 48 Vac 0.15 A max (or 60 Vdc 0.15 A max); 2 configurable inputs (optocouplers): 12 - 48 Vdc; Input reading and output update time: 1 msec; Opto-isolated analog output with 16 bits, optionally 4 - 20 mA, 0 - 5 Vdc or 0 - 10 Vdc (DGT4AN version). The maximum applicable resistance on the current output is 350 Ω while the minimum applicable resistance on the voltage output is 10 k Ω .
LOAD CELL SENSITIVITY	Maximum sensitivity of the connectable load cells: 6 mV/V.
FIELDBUS UPDATE RATES	Up to 16 Hz.

Load cell installation

After carrying out the instructions for the platform or load receiver, the shielded cable from the cell(s) must be properly connected to the terminal block(s) of the transmitter (from CELL1 to CELL4; see section “Wiring diagrams”).

The transmitter has one channel (CELL1) for 6-wire connection to load cells (using the SENSE), while for the remaining channels (CELL2, CELL3, CELL4) only 4-wire connection is allowed.

The SENSE allows you to compensate for any voltage drop on the section of cable connecting the transmitter to the load receiver. It is especially useful when the distance between the transmitter and the load receiver is more than 10 metres.

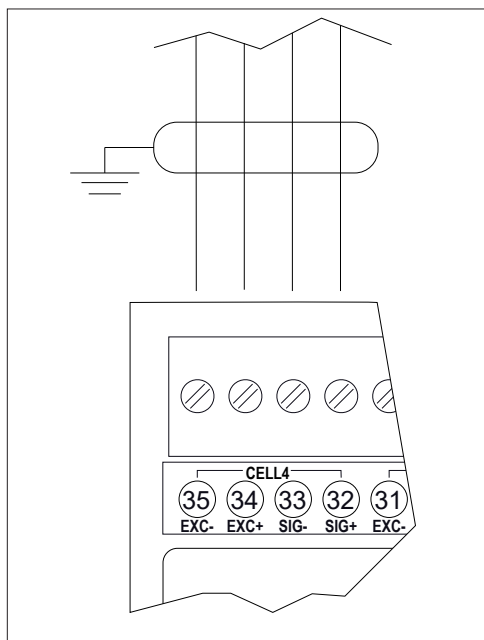

**4-WIRE CONNECTION
CELL2 / CELL3 / CELL4**

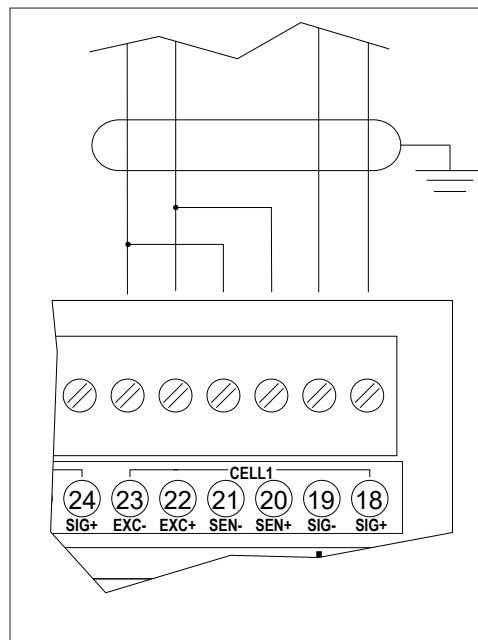

**4-WIRE CONNECTION
CELL1**

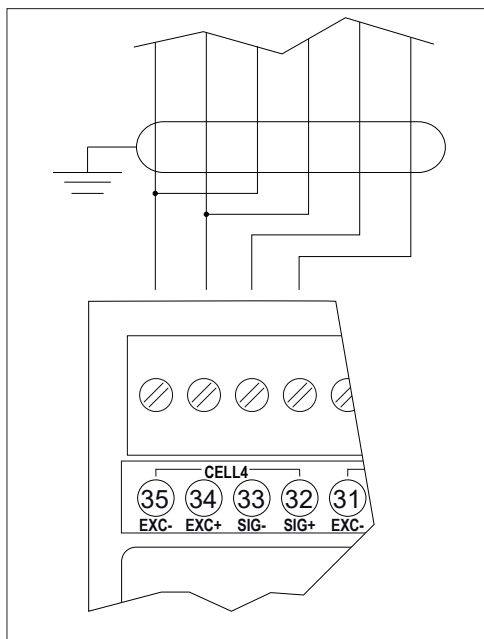

**6-WIRE CONNECTION
CELL2 / CELL3 / CELL4**

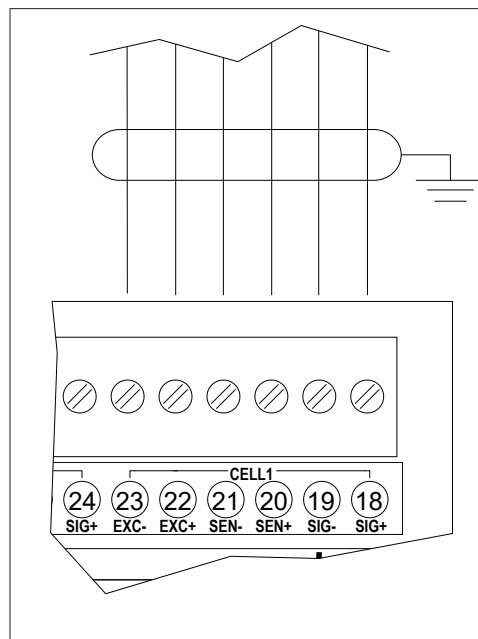

**6-WIRE CONNECTION
CELL1**

DGT4

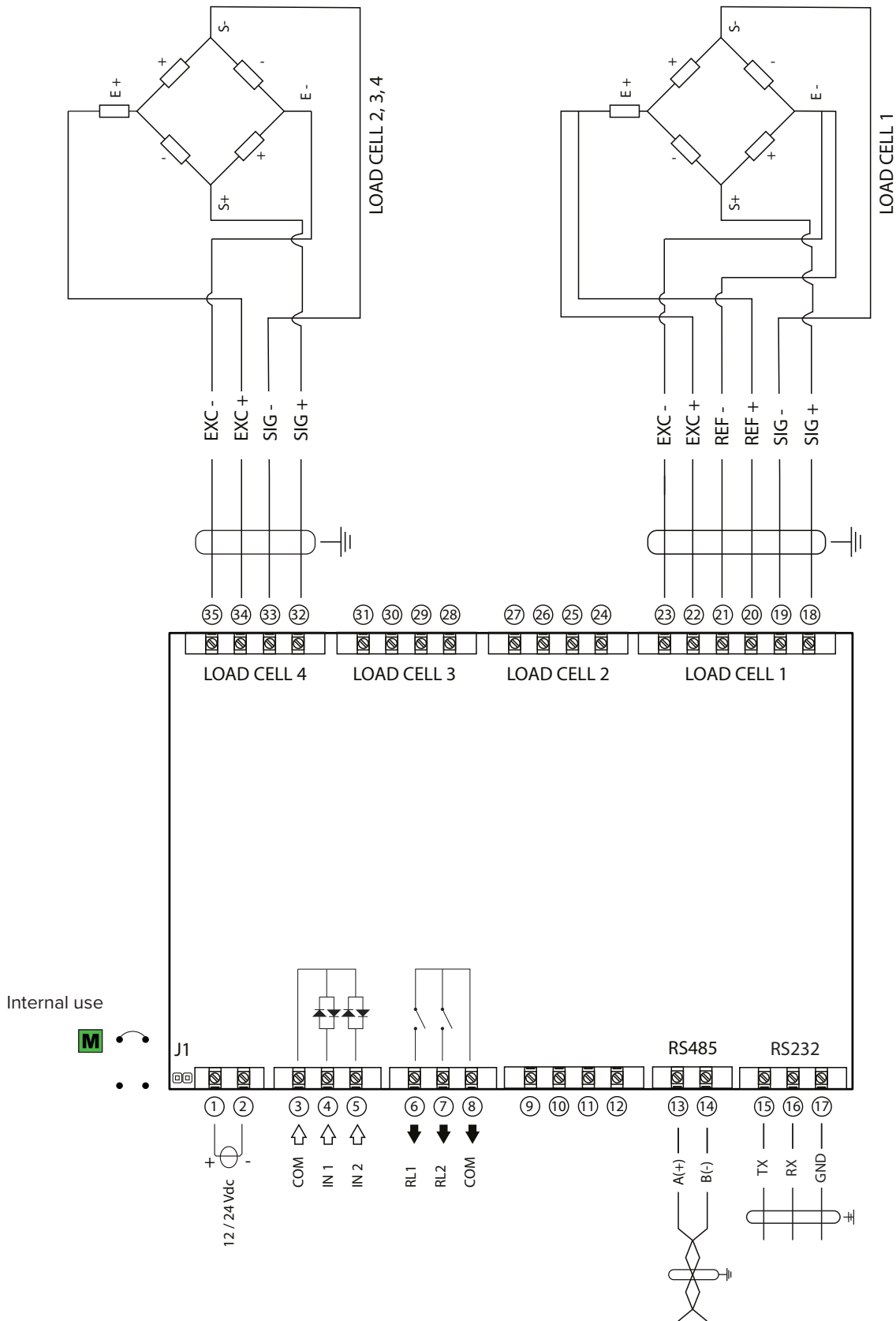

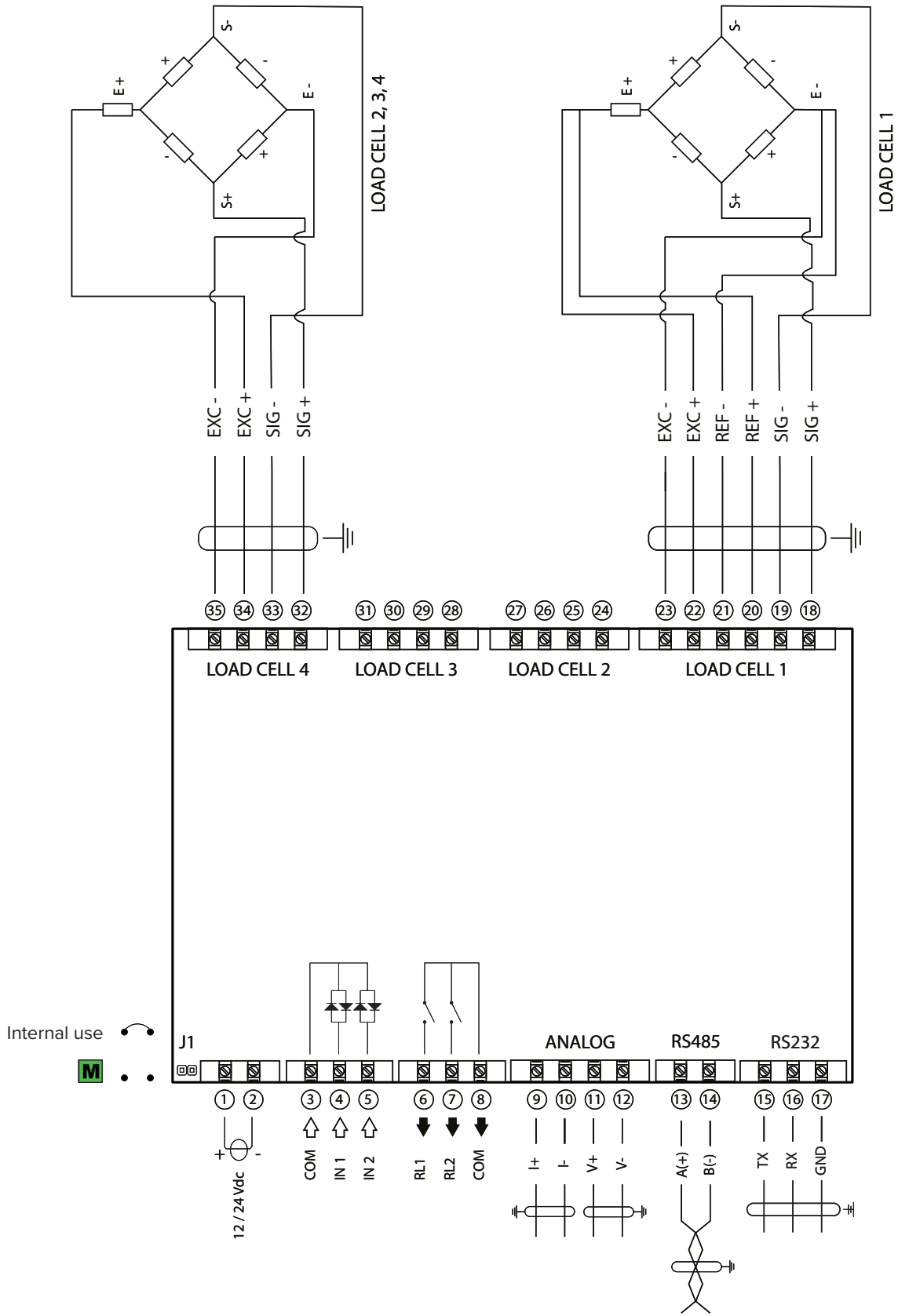

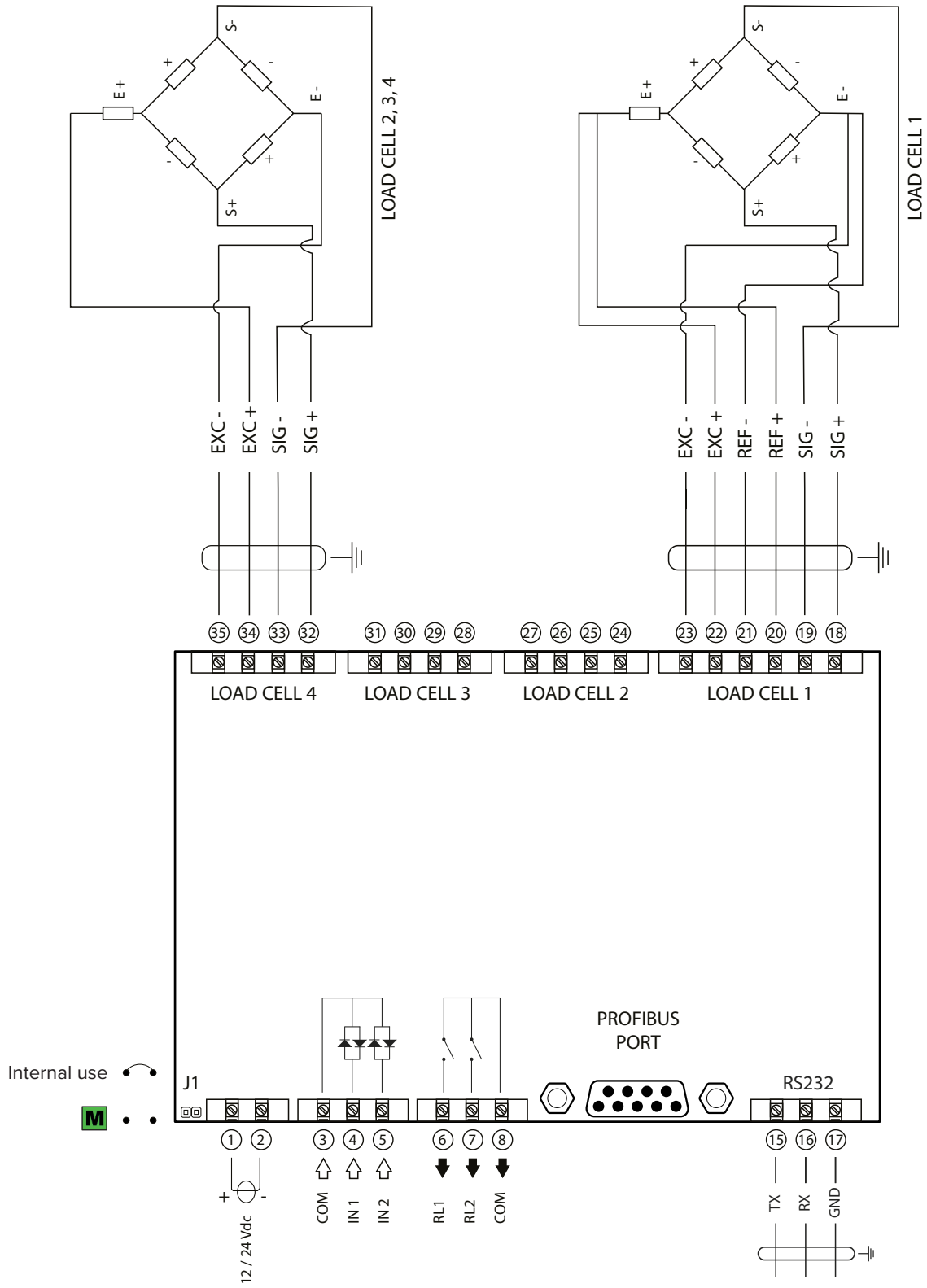

DGT4ETHIP, DGT4ETHCAT, DGT4PRONET, DGT4MODTCP

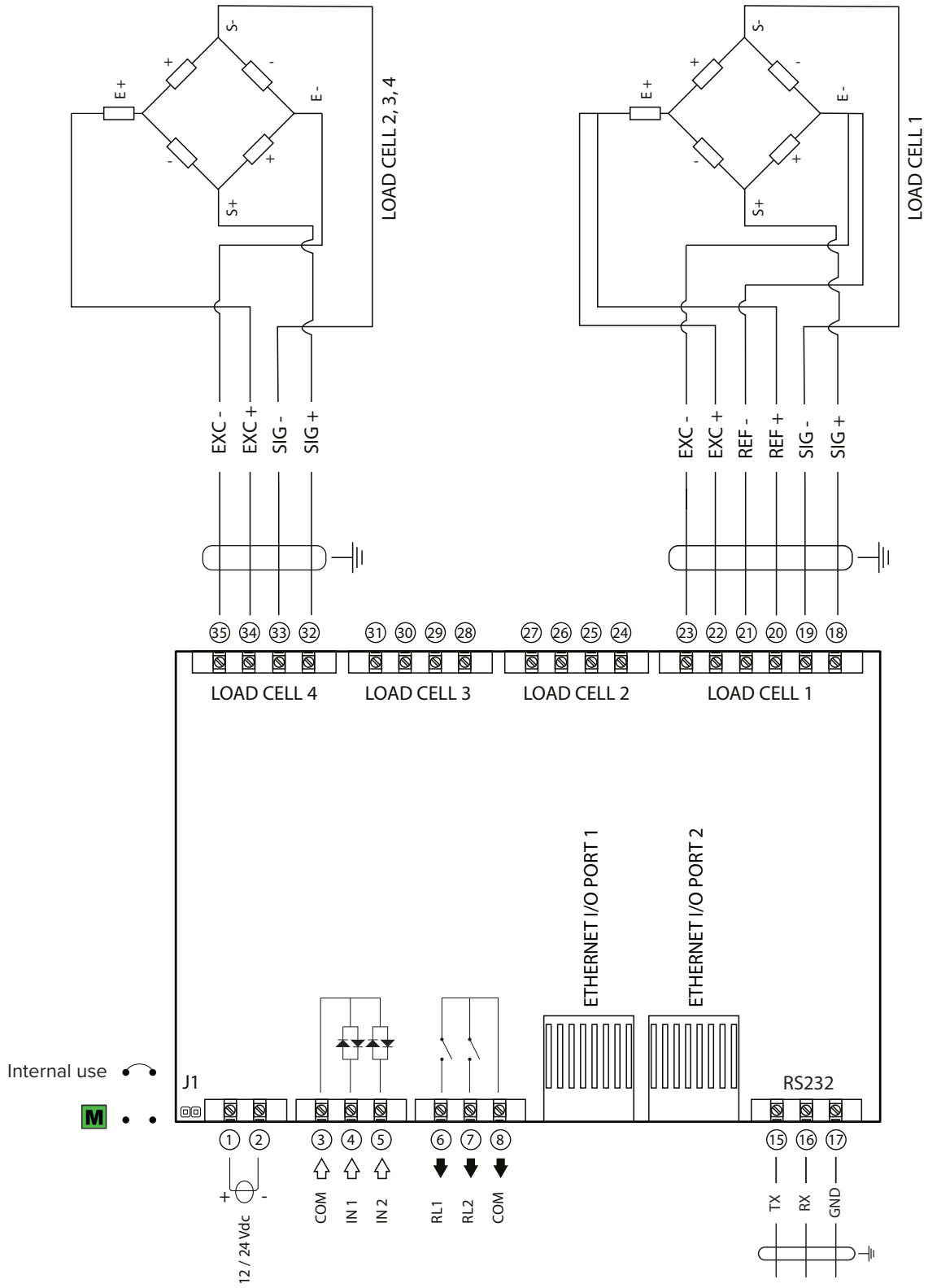

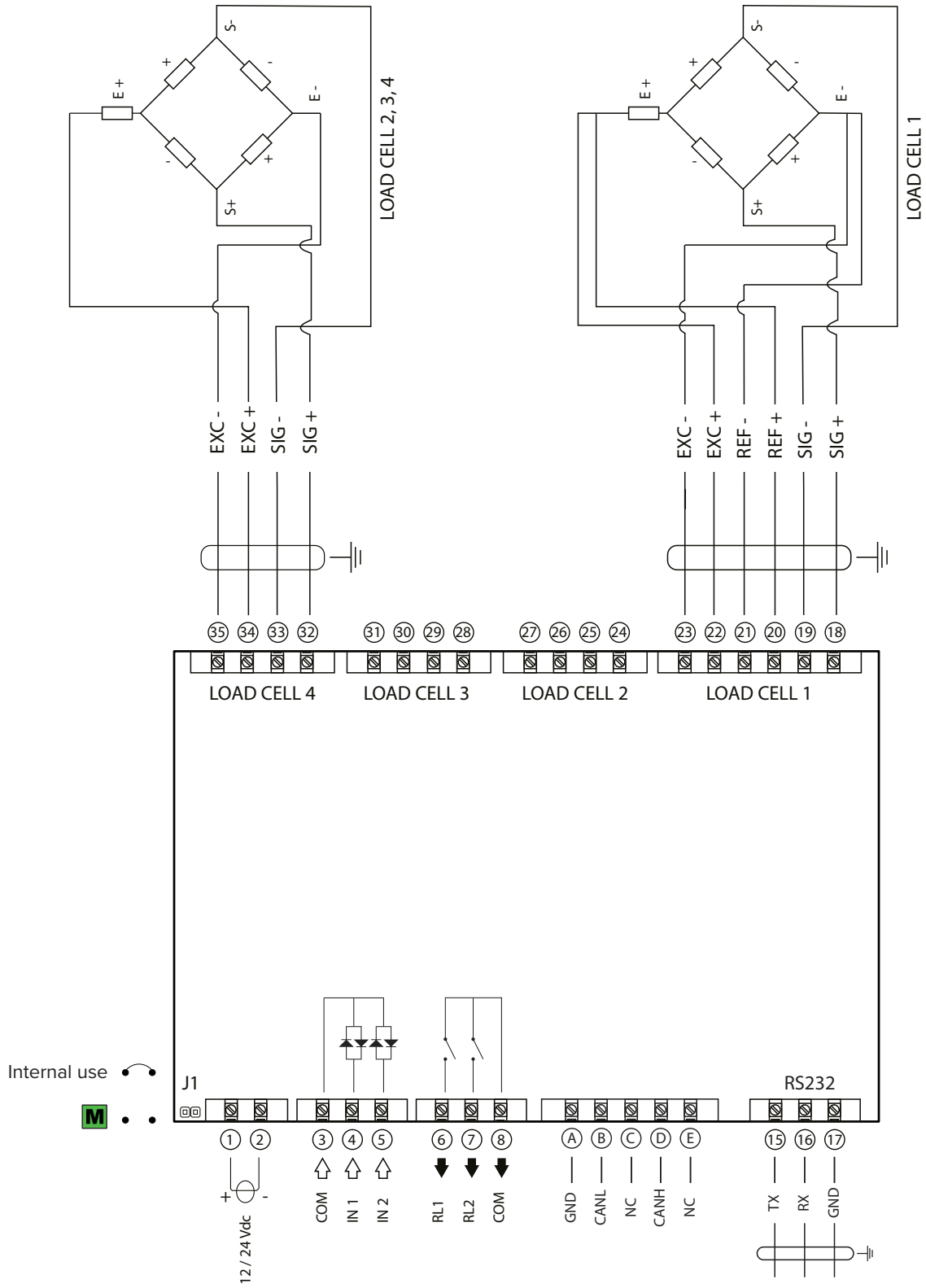

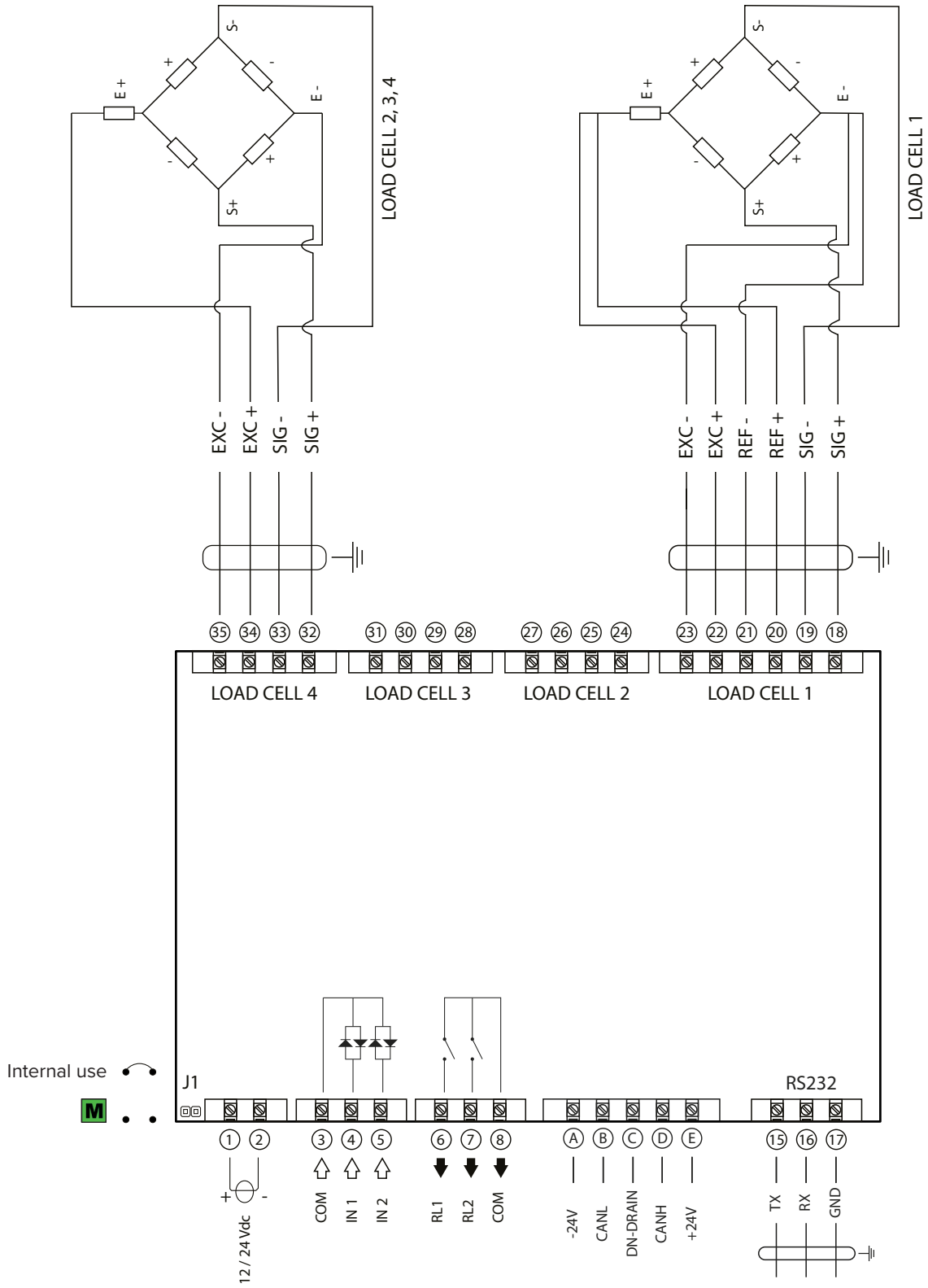

Display and function of the keys

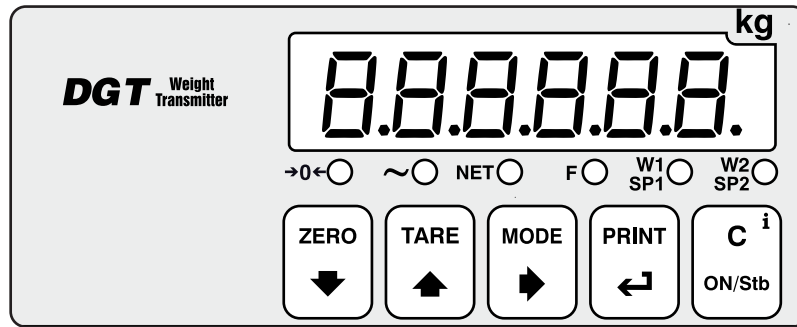

Symbol	Description
▼	Semi-automatic zeroing. Decreases the selected digit.
▲	Semi-automatic tare. Increases the selected digit.
▶	Activates the function. Selects the digit to be changed. Prolonged pressure allows you to select the active scale (only in MODE 3 "TRANSM").
↵	Confirms a value. Prints / Transmits data.
C	Turning off the transmitter.

Symbol	Description
→0←	Gross weight on zero.
~	Unstable weight.
NET	A tare is active.
F	A special function is active.
W1 SP1	Output 1 is active.
W2 SP2	Output 2 is active.

Quick menu

The transmitter is equipped with a quick menu, through which you can program the main parameters of the scale. To enter the quick menu, follow the procedure below:

1. Reboot the transmitter.
2. Press the ▶ key when the display shows **BBBBBB**.



For further information, refer to the transmitter Quick Start Guide.

Advanced programming menu

The advanced menu contains all the transmitter configuration parameters for the most advanced adjustments.

Access to the menu and saving the changes

1. Reboot the transmitter.
2. Press the ▲ key when the display shows *888888*.



HOW TO EXIT THE SETUP AND SAVE CHANGES

1. Press **C** several times, until the display shows "SAVE?".
2. Press ↵ to save or **C** to exit without saving.

Function of the keys in the menu

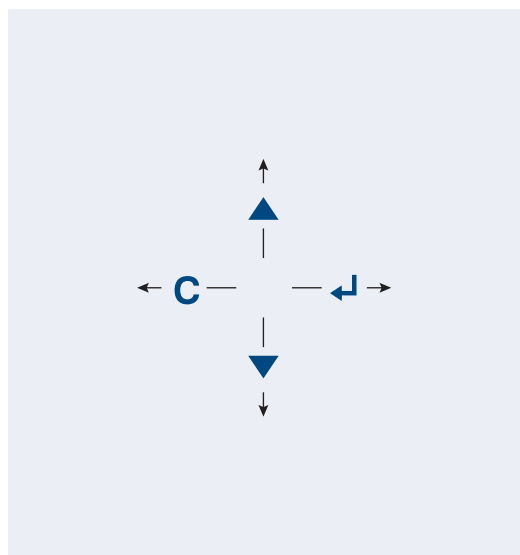

- ▲ Previous parameter.
- ▼ Next parameter.
- ↵ Access the parameter / confirm setting.
- C** Exit a parameter (without saving).

FUNCTION OF THE KEYS WHEN ENTERING NUMBERS

- ▲ Increases the selected digit.
- ▼ Decreases the selected digit.
- ▶ Selects the next digit.
- ↵ Confirms the value.
- C** Resets the value.
If pressed again, exits entering.



In the menu description on the following pages the ▼ symbol indicates repeated pressing of the ▼ key until the parameter indicated is reached.

Block diagram of the menu

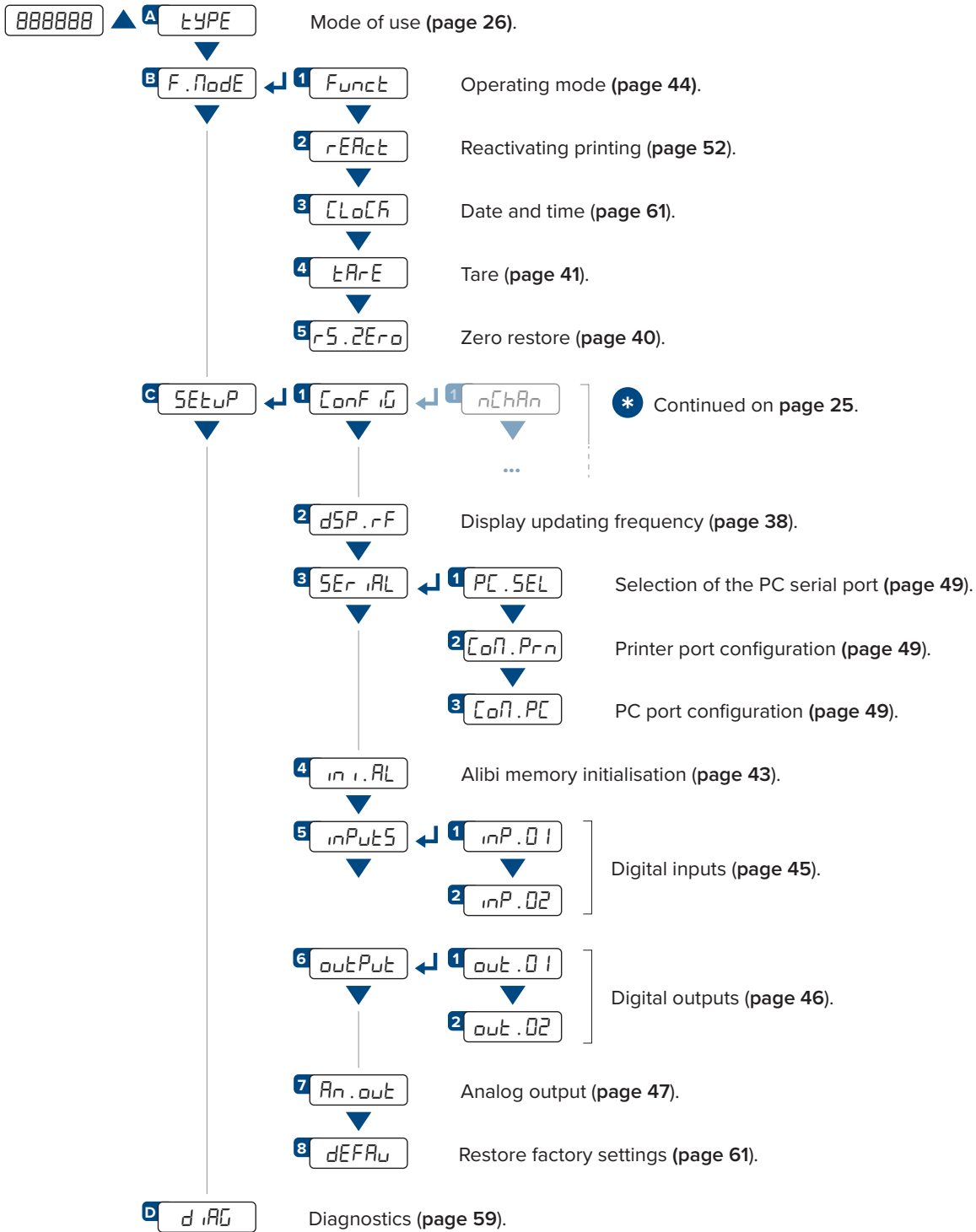

Complete menu on pages 24 - 25

MENU ACCESS:

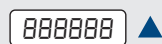

Press the ▲ key during the start-up procedure.

SAVING THE PARAMETERS:

Press the **C** key several times, until the display shows 5AUEP. Press the ↵ key to confirm.



* Full CONF ID ← SETUP Menu displayed.

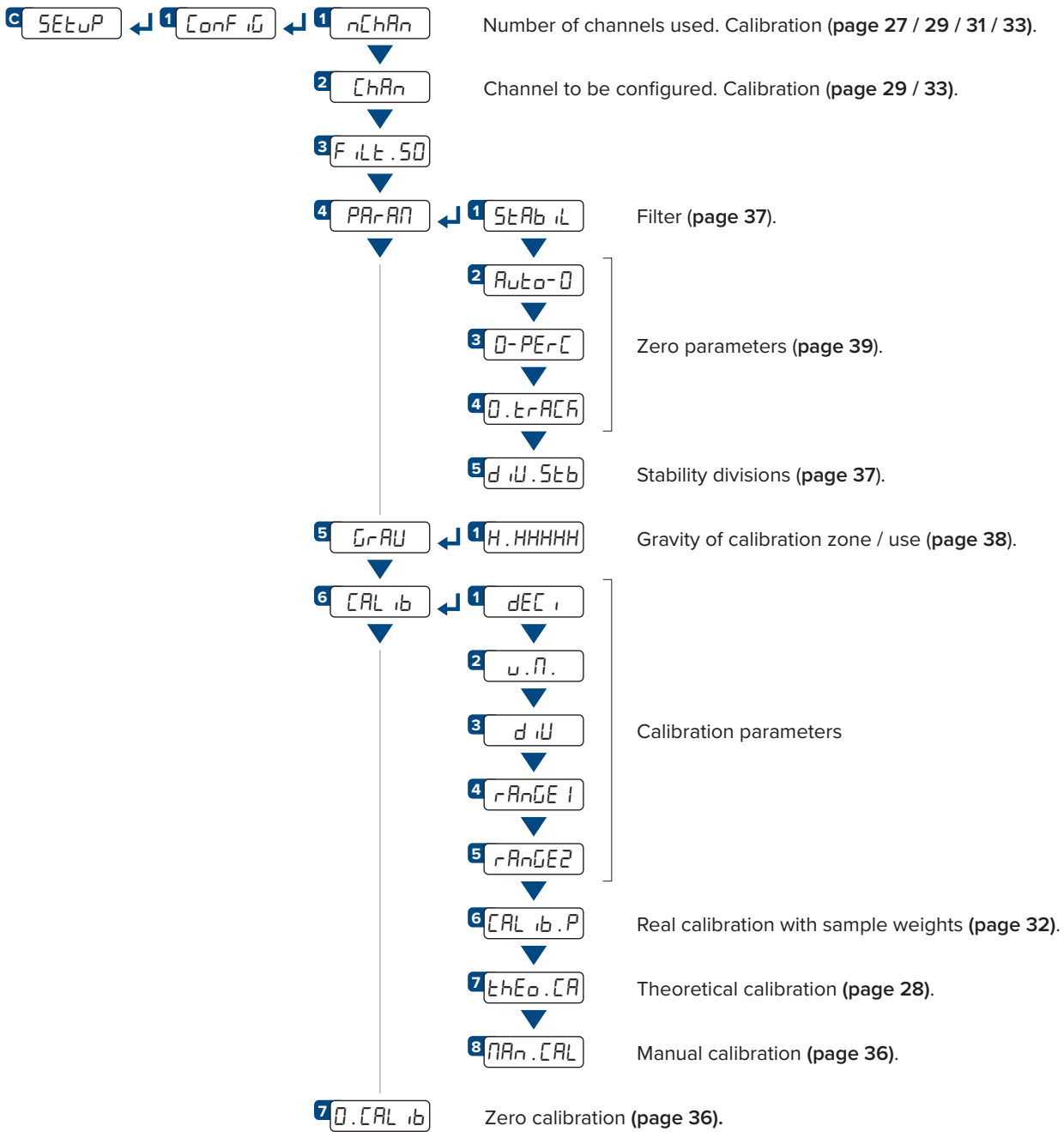

LEGEND:

-  Indicates repeated pressing of the  key.
-  Parameter visible only under certain conditions.
-  Parameter or menu subject to approval.
-  Default value of the parameter.

Mode of use of the DGT4

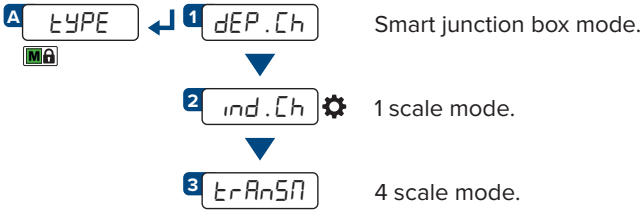

Mode 1 “DEP.CH”

Allows you to connect the load cells (from 2 to 4) directly and to equalise them.

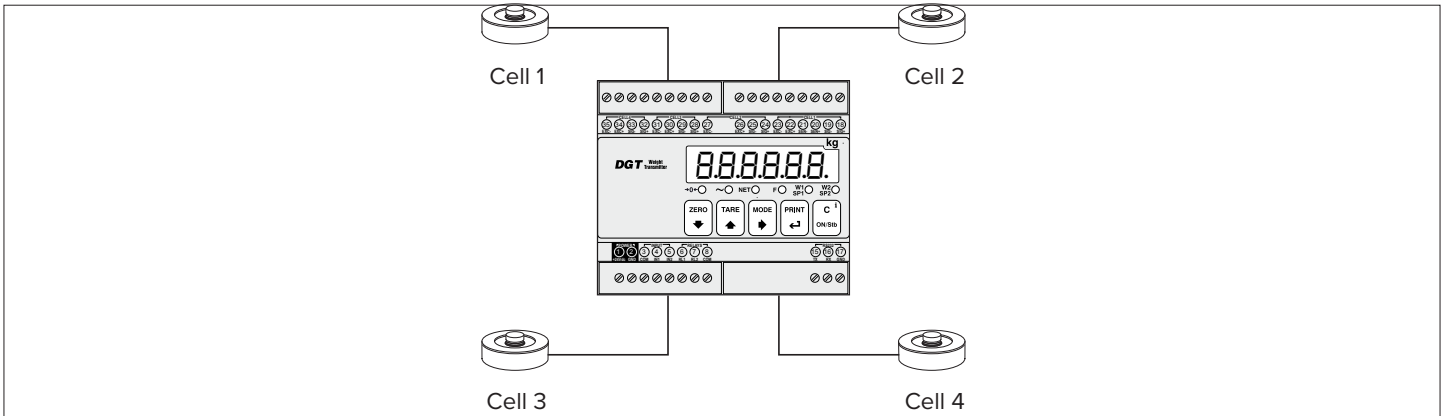

Mode 2 “IND.CH”

Allows you to connect a single cell or a multi-cell scale with a junction box.

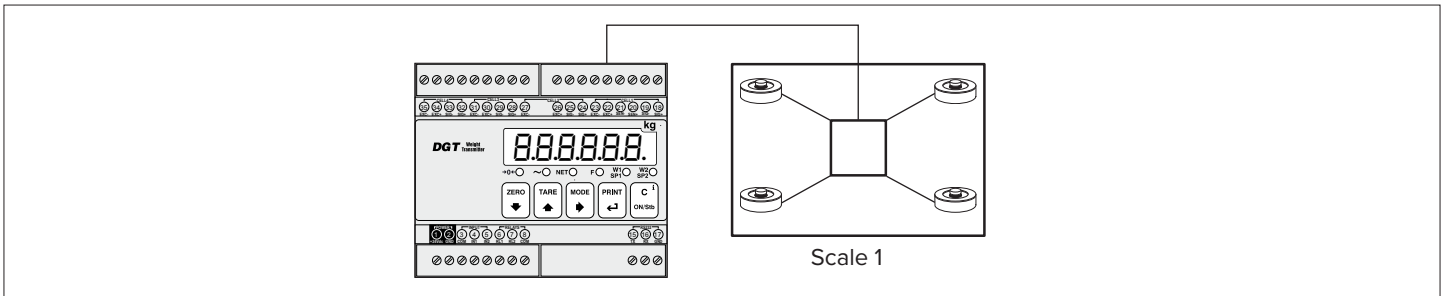

Complete menu on pages 24 - 25

MENU ACCESS:

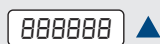

Press the ▲ key during the start-up procedure.

SAVING THE PARAMETERS:

Press the C key several times, until the display shows 5AUEP. Press the ↵ key to confirm.



Mode 3 “TRANSM”

Allows you to manage up to 4 independent scales.

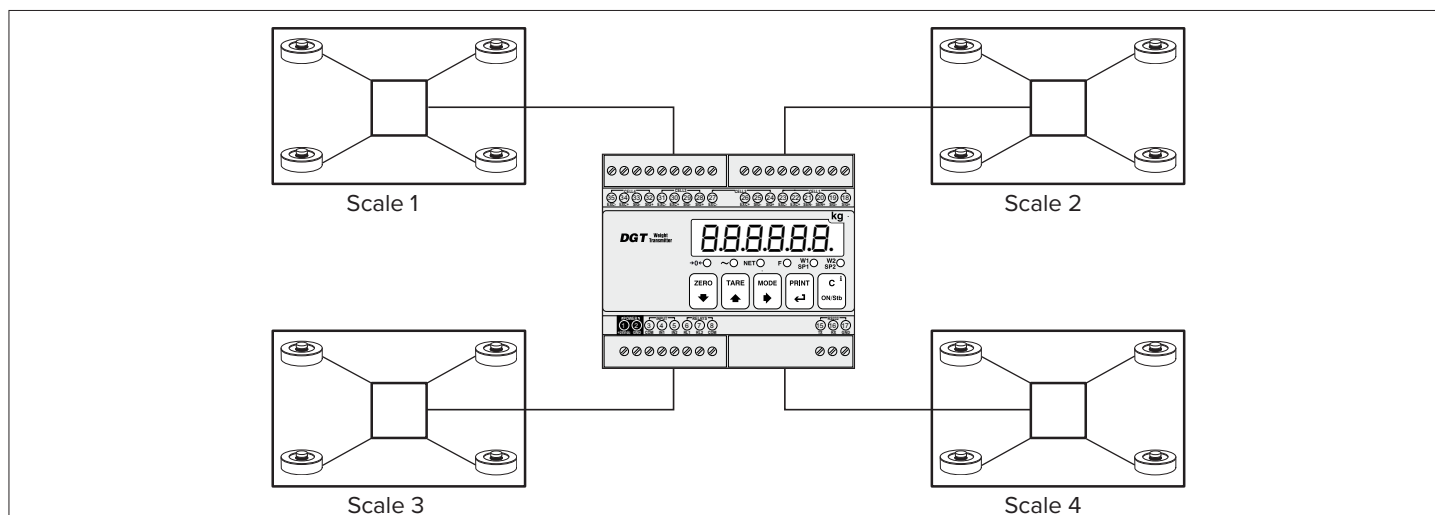

On / Off

Once powered, the transmitter switches on automatically.

STAND-BY CONDITION





During normal operation, pressing and holding the key **C** for 2 seconds switches the transmitter to standby mode.



From stand-by mode you can turn on the transmitter by pressing the key **C**.

To turn off the transmitter completely, you must shut down the power supply.

LEGEND:

-  Indicates repeated pressing of the  key.
-  Parameter visible only under certain conditions.
-  Parameter or menu subject to approval.
-  Default value of the parameter.



Dependent channels

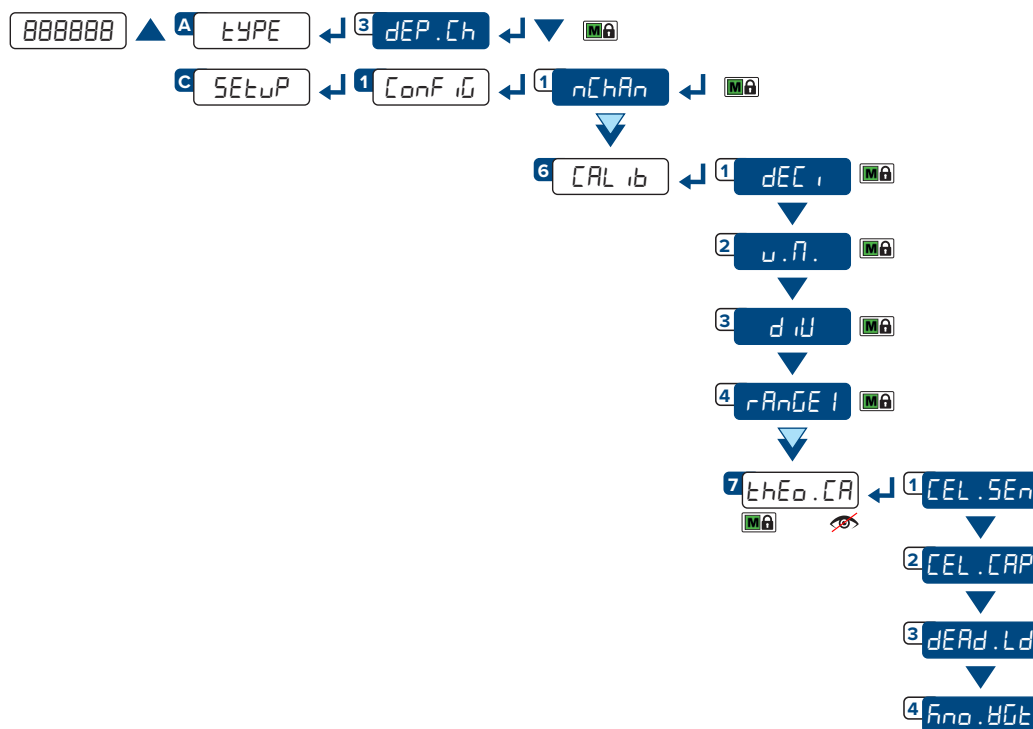

CALIBRATION PROCEDURE:

1. Select mode of use *dEP.Ch*.
2. Set the number of channels used (from 1 to 4).
3. Set the calibration parameters:
 - dEC i* = Number of decimals.
 - u.n.* = Unit of measurement (FG, G, t, Lb).
 - d iU* = Minimum division.
 - rAnGE I* = Maximum range.
4. Set the cell data:
 - SEn.CEL* = Cell sensitivity (given by the sum of the mV/V value of each cell).
 - CEL.CAP* = Total capacity of the cells (given by the sum of the capacities of each cell).
5. Enter the weight value of the structure in the *dERd.Ld* parameter. If you do not know this value, enter "0".
6. If the structure contains a quantity of material whose weight value is known (e.g. full silo), enter this value in the *hno.BUt* parameter.
7. Application of theoretical calibration:

Press the **C** key to exit the calibration menu. The display shows *th.CALP*. Press the **↵** key to confirm the use of the theoretical calibration, or the **C** key to cancel.



Complete menu on pages
24 - 25

MENU ACCESS:

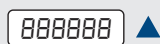

Press the **▲** key during the start-up procedure.

SAVING THE PARAMETERS:

Press the **C** key several times, until the display shows *SAUEP*. Press the **↵** key to confirm.



Independent channels / transm

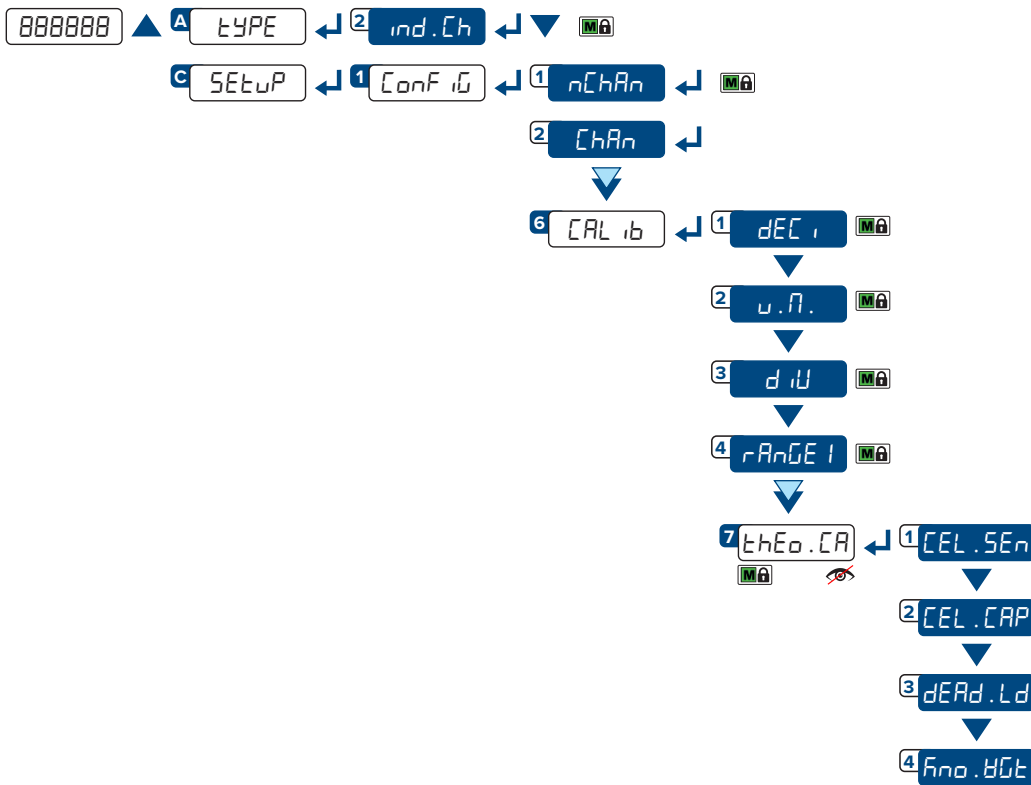

CALIBRATION PROCEDURE:

1. Select mode of use *ind.Ch*.
2. Set the number of connected scales (from 1 to 4).
3. Select the scale to be calibrated (from 1 to 4).
4. Set the calibration parameters:
 - dEC i* = Number of decimals.
 - u.n.* = Unit of measurement (*FL, G, t, Lb*).
 - d iU* = Minimum division.
 - rAnGE I* = Maximum range.
5. Set the cell data:
 - SEn.CEL* = Cell sensitivity (given by the sum of the value of each cell).
 - CEL.CAP* = Total capacity of the cells (given by the sum of the value of each cell).
6. Enter the weight value of the structure in the *dERd.Ld* parameter. If you do not know this value, enter "0".
7. If the structure contains a quantity of material whose weight value is known (e.g. full silo), enter this value in the *FnO.HGT* parameter.
8. Application of theoretical calibration:

Press the **C** key to exit the calibration menu. The display shows *th.CAL?*. Press the **↵** key to confirm the use of the theoretical calibration, or the **C** key to cancel.
9. If *trAnsm* mode has been selected, repeat the procedure from point 3 for each scale to be calibrated.

LEGEND:

- Indicates repeated pressing of the **▼** key.
- Parameter visible only under certain conditions.
- Parameter or menu subject to approval.
- Default value of the parameter.

Dependent channels (with digital equalisation)

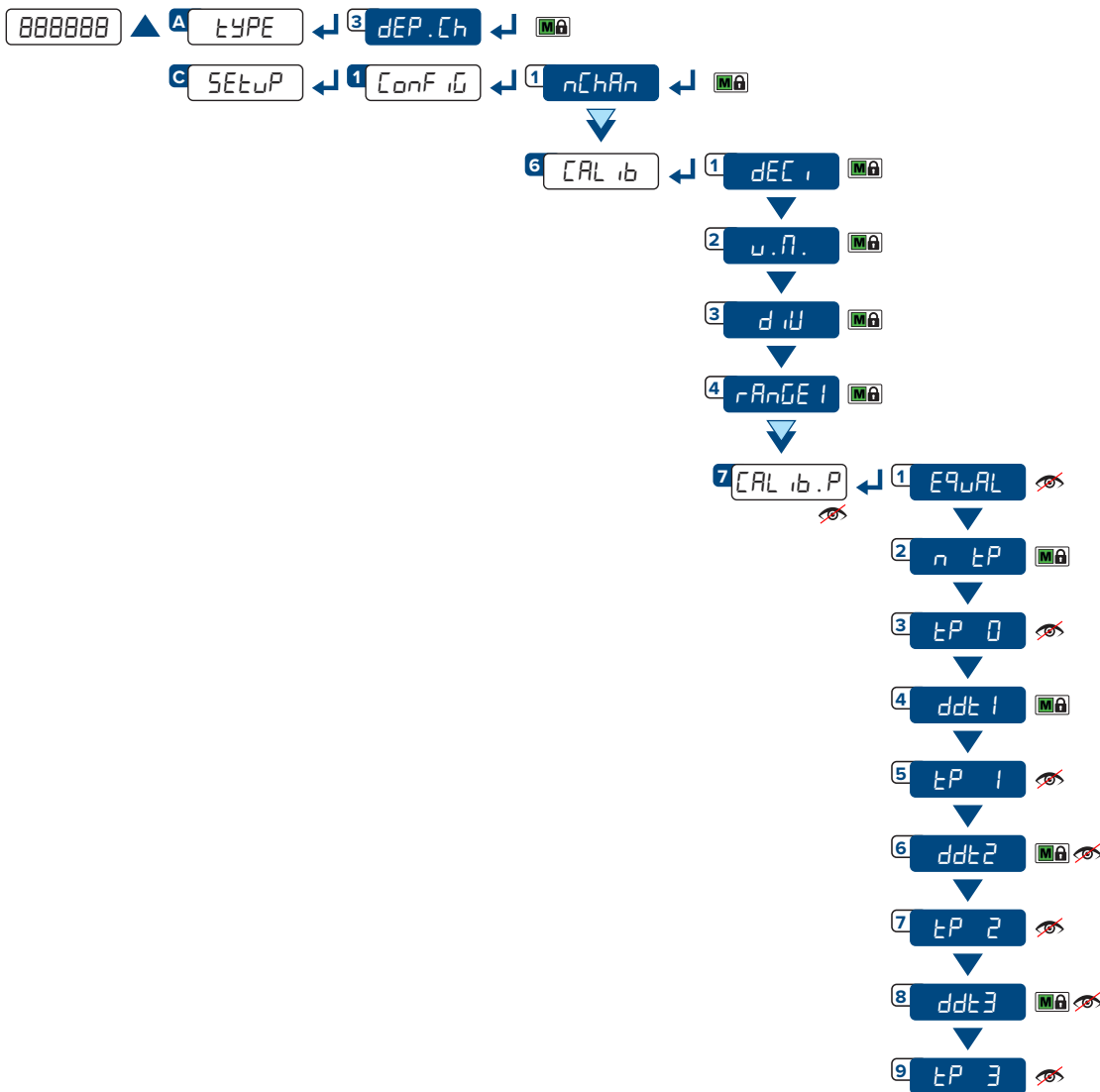

CALIBRATION PROCEDURE:

1. Select mode of use *dEP.Ch*.
2. Set the number of connected scales (from 1 to 4).
3. Set the calibration parameters:
 - dEC.* = Number of decimals.
 - u.n.* = Unit of measurement (FG, G, t, Lb).
 - d.u* = Minimum division.
 - rAnGE 1* = Maximum range.
4. Equalise the cells.

Attention: The equalisation procedure is not compulsory. However, for a good accuracy of the system, it is recommended to perform it. To perform equalisation follow the instructions on **page 33**.
5. Acquire the calibration points (*continued on next page*)



Complete menu on pages 24 - 25

MENU ACCESS:

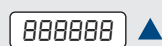

Press the ▲ key during the start-up procedure.

SAVING THE PARAMETERS:

Press the C key several times, until the display shows *SAVEP*. Press the ↵ key to confirm.



5. Acquire the calibration points:

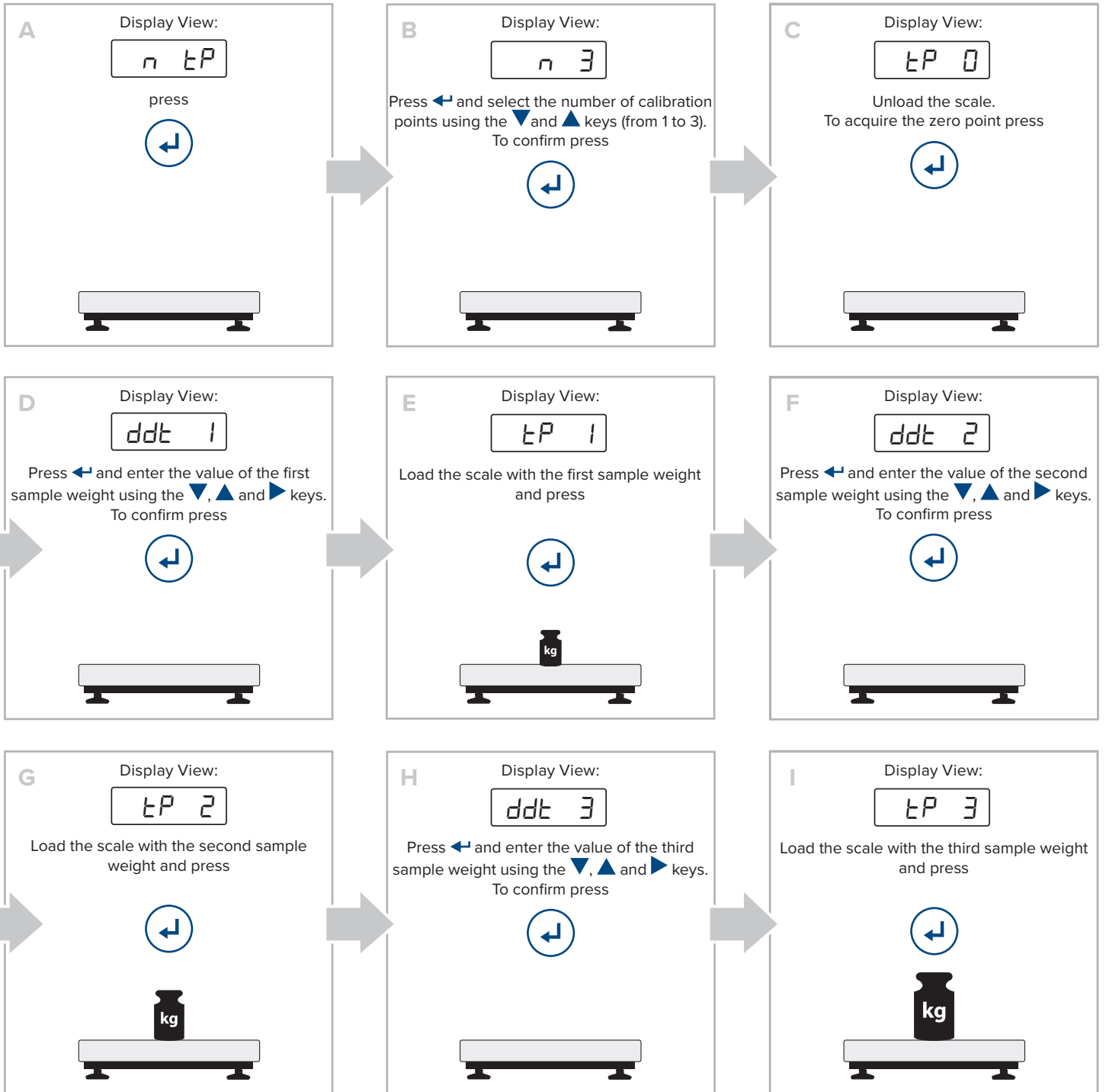

For successful calibration, the value of the largest sample weight must be at least 50% of the capacity.

LEGEND:

- Indicates repeated pressing of the key.
- Parameter visible only under certain conditions.
- Parameter or menu subject to approval.
- Default value of the parameter.

Independent channels / transm

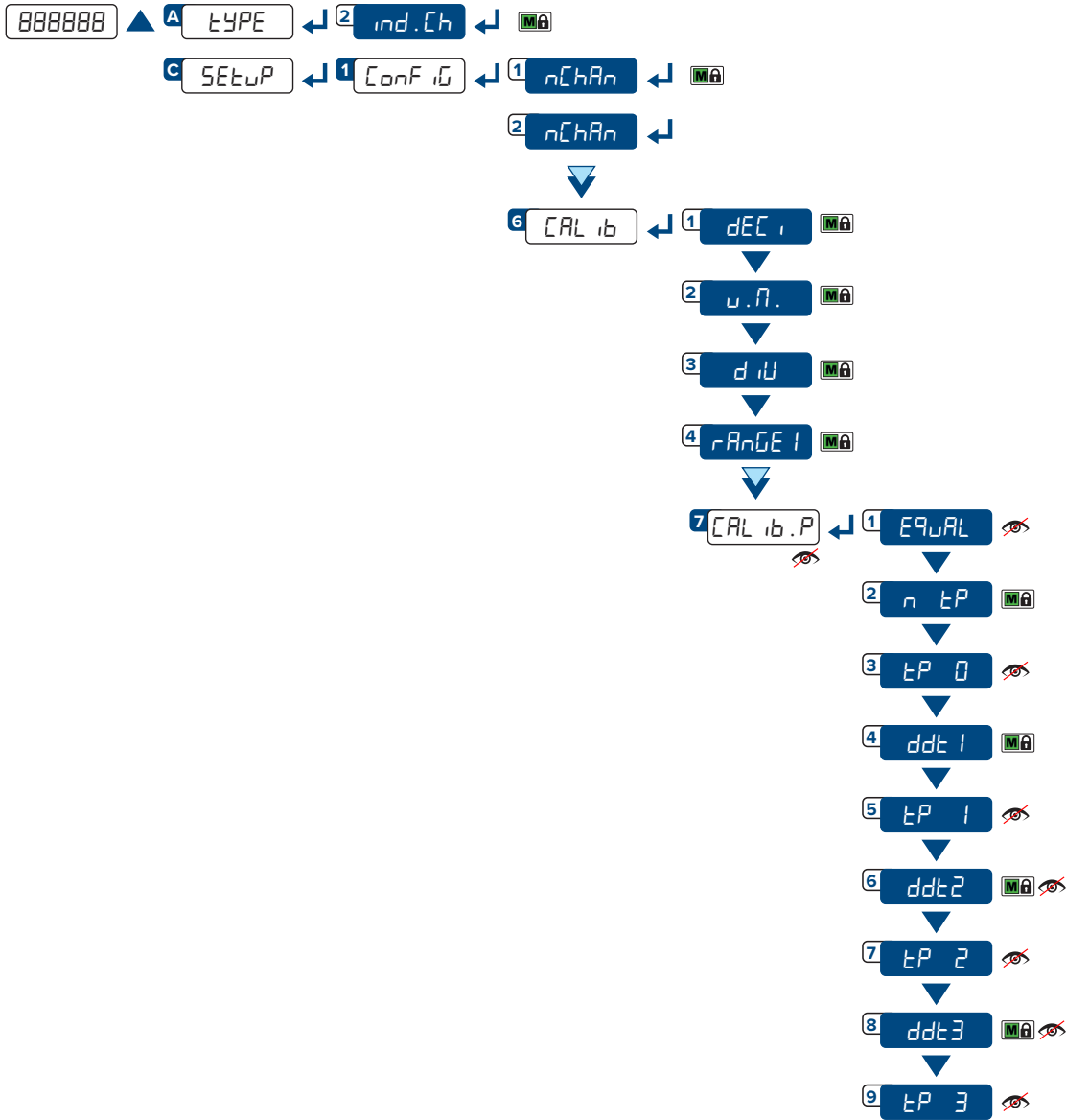

CALIBRATION PROCEDURE:

1. Select mode of use *ind.Ch*.
2. Set the number of connected scales (from 1 to 4).
3. Select the scale to be calibrated (from 1 to 4).
4. Set the calibration parameters:
 - dEC i* = Number of decimals.
 - u.n.* = Unit of measurement (Kg, G, t, Lb).
 - d.iU* = Minimum division.
 - rAnGE 1* = Maximum range.
5. Acquire the calibration points *(continued on next page)*



Complete menu on pages 24 - 25

MENU ACCESS:

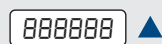



Press the ▲ key during the start-up procedure.

SAVING THE PARAMETERS:



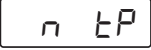

Press the C key several times, until the display shows *SAVEP*. Press the ↵ key to confirm.





5. Acquire the calibration points:

A Display View:

 press











B Display View:

 Press  and select the number of calibration points using the  and  keys (from 1 to 3). To confirm press





C Display View:

 Unload the scale. To acquire the zero point press



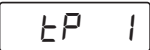



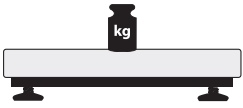



D Display View:

 Press  and enter the value of the first sample weight using the ,  and  keys. To confirm press





E Display View:

 Load the scale with the first sample weight and press



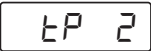



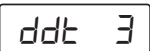

F Display View:

 Press  and enter the value of the second sample weight using the ,  and  keys. To confirm press





G Display View:

 Load the scale with the second sample weight and press

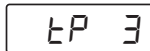

H Display View:

 Press  and enter the value of the third sample weight using the ,  and  keys. To confirm press



I Display View:

 Load the scale with the third sample weight and press



i For successful calibration, the value of the largest sample weight must be at least 50% of the capacity.

LEGEND:

-  Indicates repeated pressing of the  key.
-  Parameter visible only under certain conditions.
-  Parameter or menu subject to approval.
-  Default value of the parameter.

Equalisation

If the dependent channel mode has been set, you can improve the accuracy of the system by digitally equalising the connected cells.

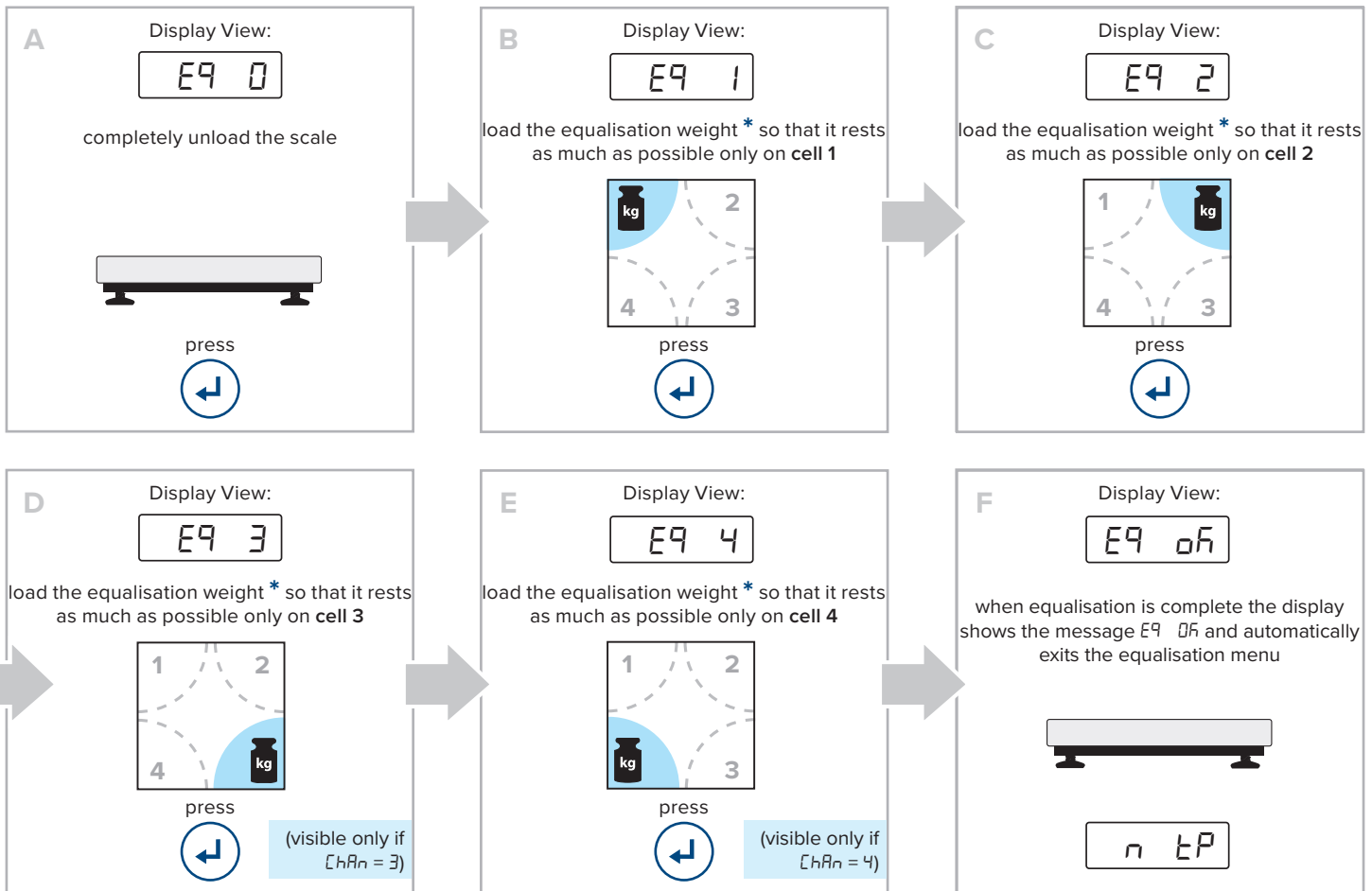
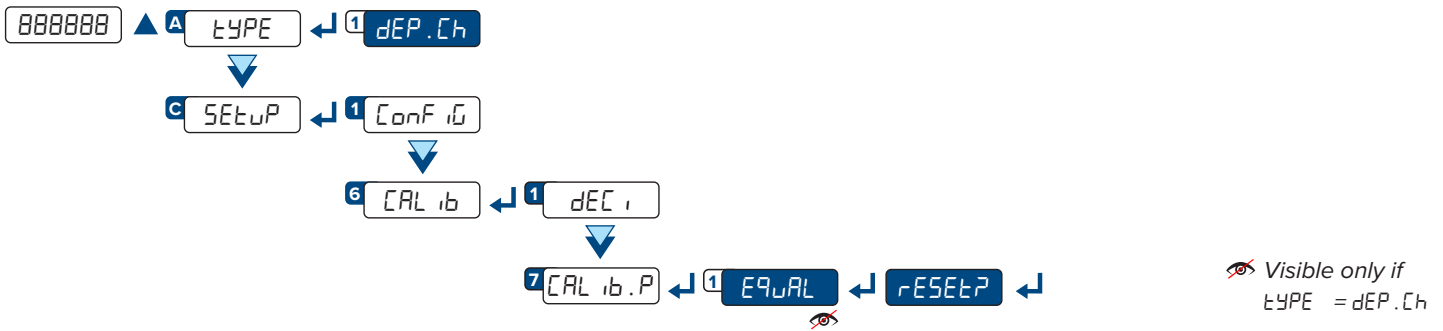

i Equalisation can only be performed if the system is configured with dependent channels and calibration with sample weights is active.

***** For successful equalisation, it is advisable to use a compact weight with as small a supporting surface as possible, so that it rests as much as possible on only one cell. The weight value must be at least 20% of the capacity.

Complete menu on pages 24 - 25

MENU ACCESS: 888888 ▲ Press the ▲ key during the start-up procedure.

SAVING THE PARAMETERS: Press the C key several times, until the display shows SAUEP. Press the ← key to confirm.

Manual calibration

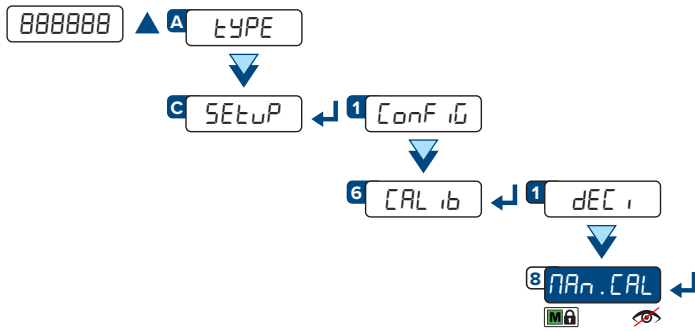

If you know the number of ADC converter points for a known weight (for example if you want to copy the calibration from one transmitter to another) the calibration points can be entered manually:

1. The display shows `Mod.Pnt`, proceed by pressing the `↵` key.
2. Using the `▲` and `▼` keys, select the calibration point you want to enter / change (from 0 to 3). Press the `↵` key to confirm.
3. The display shows `WEIGHT`, use the `▲`, `▼` and `▶` keys to enter the weight value. Press the `↵` key to confirm.
4. The display shows `Points`, use the `▲`, `▼` and `▶` keys to enter the converter points value. Press the `↵` key to confirm.

i Repeat the procedure for each calibration point. If `TRANSD` mode has been selected, the procedure must be repeated for each scale (Chan 2, 3, 4).

Quick zero calibration (pre-tare zeroing)

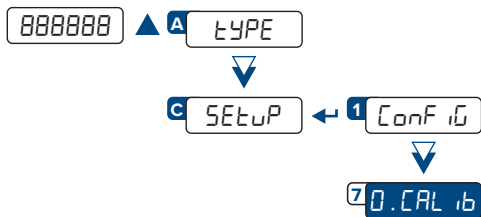

i If `TRANSD` mode has been selected, it is first necessary to select the channel on which the zero calibration is to be performed (Chan 1, 2, 3, 4).

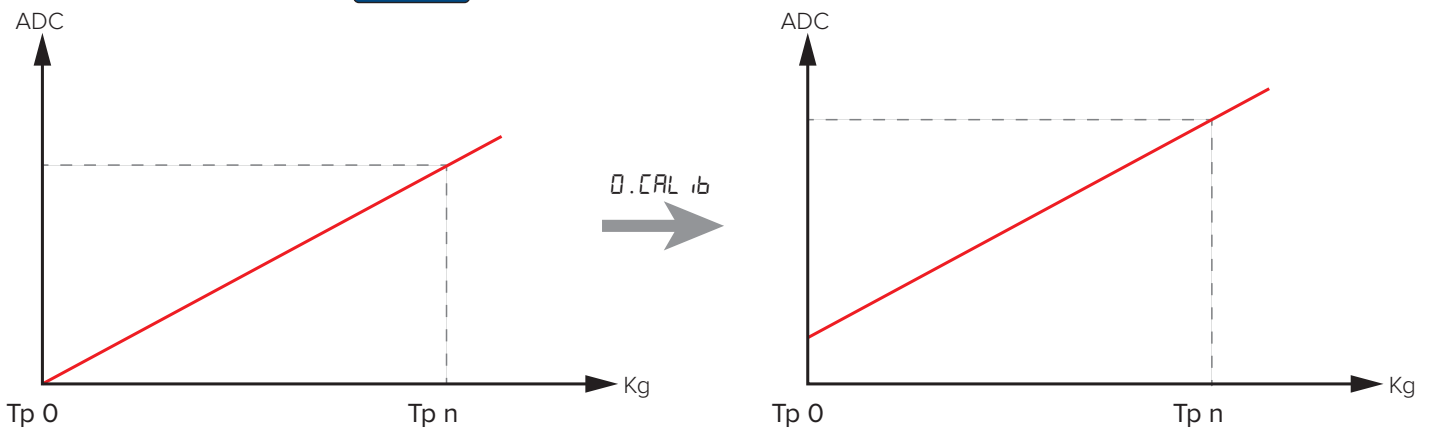

LEGEND:

- Indicates repeated pressing of the `▼` key.
- Parameter visible only under certain conditions.
- Parameter or menu subject to approval.
- Default value of the parameter.

Filter adjustment

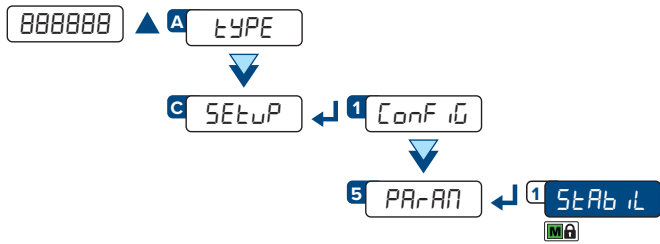

Filter	Response time (ms)	Updating frequency (Hz)	Filter	Response time (ms)	Updating frequency (Hz)
h.r.0	1230	6	FLt 2	590	25
h.r.1	1435	6	FLt 3	980	25
h.r.2	1840	6	F.F.50.1	440	50
h.r.3	2050	6	F.F.50.2	390	50
h.r.4	3280	6	F.F.50.3	340	50
h.r.5	4100	6	F.F.100.1	110	100
h.r.6	4920	6	F.F.100.2	210	100
dYn.0	1640	6	F.F.100.3	260	100
dYn.1	2050	6	F.F.100.4	280	100
dYn.2	2460	6	F.F.200.1	170	200
dYn.3	2460	6	F.F.200.2	155	200
FLt 0	250	25	F.F.200.3	140	200
FLt 1	390	25	F.F.400	50	400

i In the case of an approved instrument, it is possible to select only FLT F ILtEr5.

Stability detection sensitivity

It is possible to decide that tare, zero and print functions (from keypad or serial command / PLC) are performed only if the weight is stable.

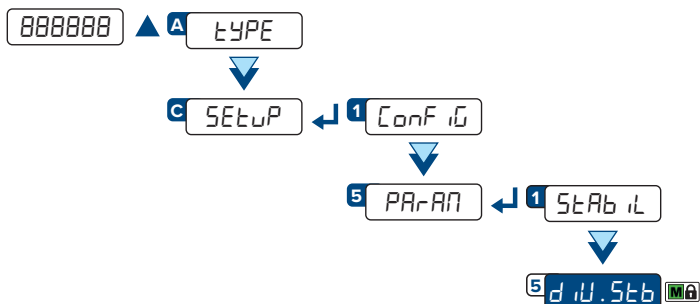

The value 0 disables the stability control.
 By entering a value other than 0, you enable stability control.
 Enter the number of deviation divisions beyond which the transmitter detects instability.

From 0 to 99.
 ⚙ = 02.
 M = 02.

Complete menu on pages 24 - 25

MENU ACCESS:

888888 [A] Press the [A] key during the start-up procedure.

SAVING THE PARAMETERS:

Press the [C] key several times, until the display shows SAUEP. Press the [Enter] key to confirm.

Display updating frequency

Additional filter that acts only by displaying the weight, thus increasing its stability.

Useful in particular applications where you want to make the weight more stable in the eyes of the operator.

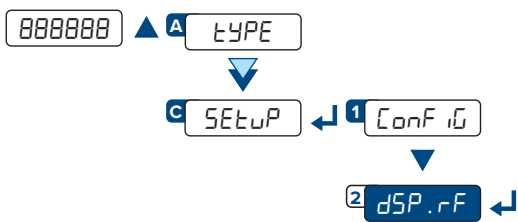

i This parameter does not affect the actual speed and stability of the weight (set via the filter). It only affects the indication of the weight on the display.

- 1** `nor 1` Function disabled.
- 2** `1 h2` 1 display update per second.
- 3** `2.5 h2` 2.5 display updates per second.
- 4** `5 h2` 5 display updates per second.
- 5** `10 h2` 10 display updates per second.
- 6** `20 h2` 20 display updates per second.

Gravity

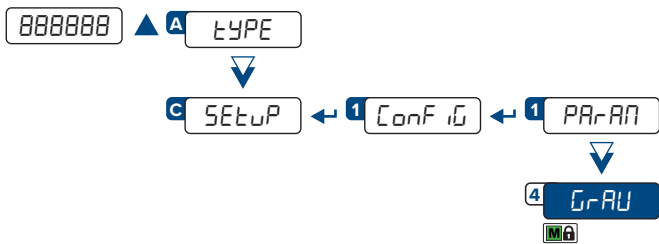

From 9.7500 l to
9.84999.
 = 9.80390.

This parameter allows you to correct the gravity acceleration value.
Before calibration, set the value of the calibration zone.
Next, set this value to the value of the zone of use.
Any difference between the two values will be automatically compensated.

i In the case of an approved transmitter, the value is read-only.

EXAMPLE:



Calibration zone
Italy
g = 9.80390



Zone of use
Brazil
g = 9.77623

- 1.** Before calibration, in the `GrAU` parameter enter the value 9.80390.
- 2.** Calibrate the transmitter.
- 3.** Before using the transmitter, in the `GrAU` parameter enter the value 9.77623.

LEGEND:

- Indicates repeated pressing of the key.
- Parameter visible only under certain conditions.
- Parameter or menu subject to approval.
- Default value of the parameter.



Zeroing parameters

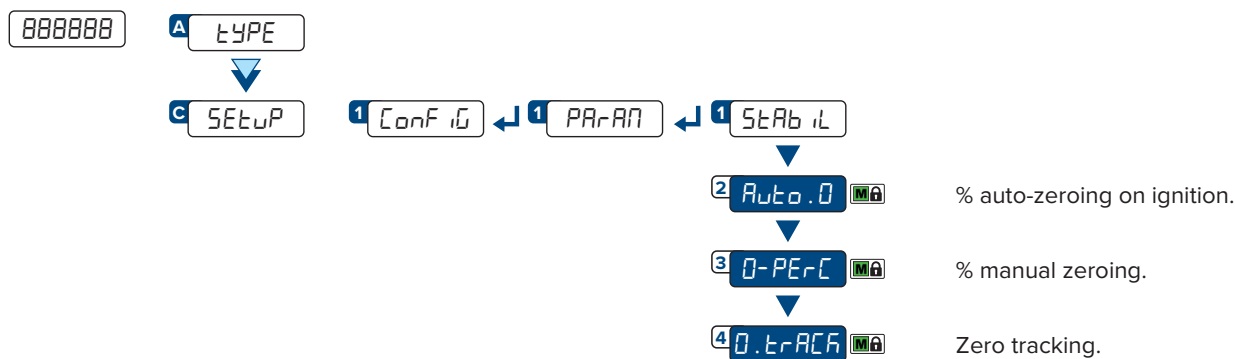

Auto-zeroing on ignition

2 Auto.0 ← 1 d.5Ab Disabled.

2 EnAb ← 1 C.PERC Enabled, enter in C.PERC the % value of the capacity. from 0 to 50%.

3 CYCLE ← 1 C.PERC In ind.Ch mode, it is possible to perform an auto-zeroing cycle of all connected scales. Enter in C.PERC the % value of the capacity. from 0 to 10%.

Visible only if TYPE ≠ ind.Ch

Maximum percentage of manual zeroing

3 0-PERC ← Indicates the weight value that can be zeroed by key or command. from 0 to 50%.

The value is expressed as % of the full scale. For example: if the scale has a full scale (RANGE1) of 1000 kg, by setting 3% it is possible to zero up to 30 kg. from 0 to 2%.

The value 0 disables the ZERO key and the zeroing commands. = 2%.

Zero tracking

This menu allows to set zero tracking, i.e. the compensation parameter of the thermal drift of the scale; the set value corresponds to the number of divisions that is reset to zero in the fixed time of 1 second.

4 0-PERC ← 1 tr 10 10 divisions.

2 tr 8 8 divisions.

3 tr 6 6 divisions.

4 tr 4 4 divisions.

5 tr 2 2 divisions.

6 tr 1 1 division.

7 tr 1/2 1/2 division.

8 tr 1/4 1/4 division.

9 tr no Tracking disabled.

In the case of an approved transmitter, it is possible to select the values tr 1/2, tr 1/4, tr no.

Complete menu on pages 24 - 25

MENU ACCESS:
888888 Press the key during the start-up procedure.

SAVING THE PARAMETERS:
Press the key several times, until the display shows SETUP. Press the key to confirm.

Restoring zero

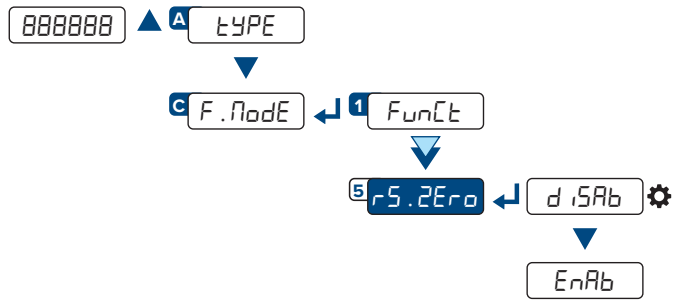

Restoring zero disabled.

Restoring zero enabled.

• If $R_{uto}.D = d,SRb$:

The last zeroing in the memory before turning off the power is always restored.

• If $R_{uto}.D = EnRb / CYCLE$:

The last zeroing in the memory before turning off the power is restored only if the auto-zeroing fails.

Semi-automatic zeroing

By pressing the ▲ key, or sending the zero command, the transmitter zeroes the gross weight on the scale. For a moment the display shows “zEr0” and then it shows 0 (gross weight).

The semi-automatic zeroing cannot be performed if:

- The weight on the scale is greater than the zero capacity ($D.PErC$).
- The weight is unstable.

LEGEND:

- Indicates repeated pressing of the ▼ key.
- Parameter visible only under certain conditions.
- Parameter or menu subject to approval.
- Default value of the parameter.



Tare mode

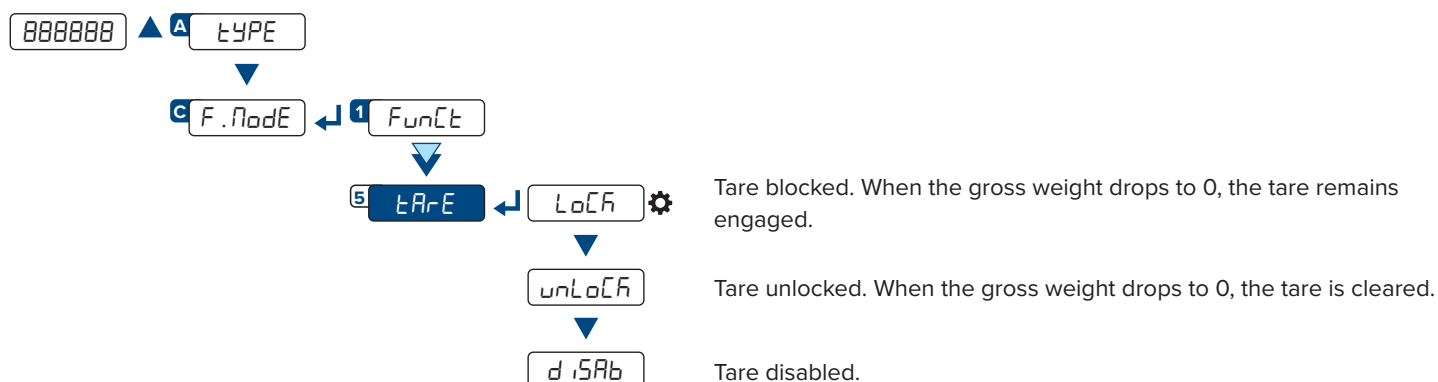

Semi-automatic tare

By pressing the ▲ key, or sending the tare command, the transmitter sets as tare the weight on the scale. For a moment the display shows "tArE" and then it shows 0 (net weight). The **NET** light indicates that the net weight is shown on the display.

The semi-automatic tare cannot be performed if:

- The weight is less than one division.
- The weight is overloaded.

Predetermined tare

By holding down the ▲ key, or by means of the predetermined tare command, it is possible to enter a tare value manually. For a moment the display shows "-tT-" and shows the tare present (or 0 if no tare is present). Enter the tare value and press ↵ to confirm.

Clearing the tare

The tare can be cleared in different ways:

- By unloading the scale and performing a semi-automatic tare.
- By entering a predetermined tare value of 0.
- If the weight is negative, pressing the ▼ key.



Complete menu on pages
24 - 25

MENU ACCESS:

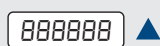

Press the ▲ key during the start-up procedure.

SAVING THE PARAMETERS:

Press the C key several times, until the display shows 5AUEP. Press the ↵ key to confirm.



The alibi memory allows you to store the weight values transmitted to the computer for further processing and/or data integration. The stored values can then be retrieved from the PC port or directly on the display of the transmitter for later checking.

Enabling the alibi memory

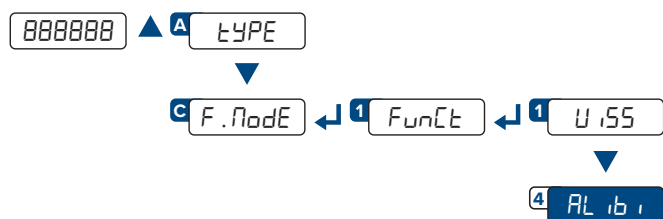

Saving a weighing operation in the alibi memory

A weighing operation is stored after receiving the **PID** serial command (see “Serial commands” page 56) or after pressing the key. The transmitter transmits on the PC port the gross weight, the tare and an ID code that uniquely identifies the weighing. The ID has the following format:

- rewrite number: 5-digit number (from 00000 to 00255) indicating the number of complete rewrites;
 - weighing number: 6-digit number (from 000000 to 131072) indicating the weighing number in the current rewrite.
- Each time it is saved, the weighing number is increased by 1; when it reaches the value 131072, it starts again from 000000 and the rewrite number is increased by 1.

Example

If the weighing that has been saved is as follows:

PIDST,1, 1.000kg, 1.000kg,00126-131072

The next one will be:

PIDST,1, 1.000kg, 1.000kg,00127-000000

A weighing operation can only be saved if the weight ≥ 0 , stable and valid (not underloaded or overloaded). To store the weighing operation by key, the function must be active (see “Reactivating printing” on page 52). In addition, if the transmitter is approved, the weight must exceed 20 divisions.

If these conditions are not met:

- the response to the PID command will have “NO” instead of the ID (**PIDST,1, 1.000kg, 1.000kg,NO**);
- there is no transmission when the key is pressed.

LEGEND:

- Indicates repeated pressing of the key.
- Parameter visible only under certain conditions.
- Parameter or menu subject to approval.
- Default value of the parameter.

Reading the alibi memory

FROM THE TRANSMITTER (MANUAL)

By pressing the **▶** key you can read a saved weight:

you will be asked to enter the rewrite number "rEB . id" (from 0 to 255) and the ID number " id" (from 0 to 131072).

The weighing data are shown. Use the **▼** and **▲** keys to scroll through the following information:

- "Ch . X", where X indicates the scale number.
- "un YY", where YY indicates the unit of measurement (Fg, G, E or Lb).
- "Gross", followed by the gross weight.
- "TARE / TAREPL", followed by the tare value.

Press the **C** key to return to weighing.

The weighing of an ID can only be verified if:

- it has a rewrite number equal to the current alibi memory number and a weighing number \leq the last value received with the PID command;
- it has a rewrite number ≥ 0 , but 1 less than the current alibi memory value, and a weighing number greater than the last value received with the PID command.

FROM PC

To read a weighing operation from a PC, see the serial command "READING A WEIGHING OPERATION IN THE ALIBI MEMORY" on page 56.

FROM PLC

To read a weighing operation from a PLC, refer to the Modbus and Fieldbus protocol manuals.

i If the alibi memory is empty, when the **▶** key is pressed the display shows "EMPTY" for one second and returns to weighing mode. If an invalid ID is entered, the display shows "no id" and returns to weighing mode.

Initialising the alibi memory

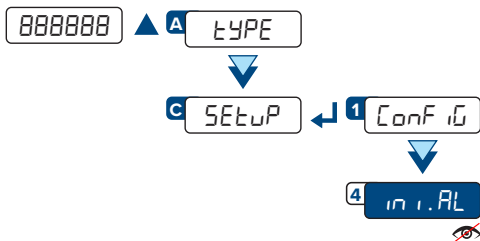

~~Not visible if the transmitter is approved.~~

i This operation deletes all saved weighing operations; it is not possible to delete a weighing operation individually.



Complete menu on pages 24 - 25

MENU ACCESS:

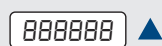

Press the **▲** key during the start-up procedure.

SAVING THE PARAMETERS:

Press the **C** key several times, until the display shows **SAVEP**. Press the **↵** key to confirm.



Use functions

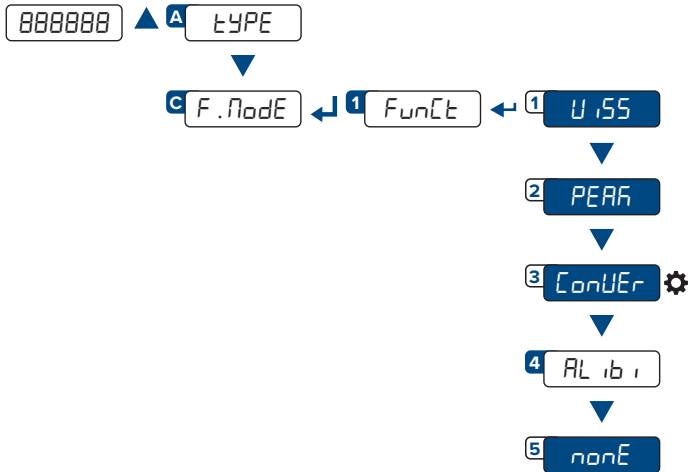

High resolution

U 155

Weight display in high resolution (x10). Press the key to activate or deactivate the function.

When the weight is displayed in high resolution, the indicator light **F** is lit.

In the case of an approved transmitter, the high-resolution weight display is automatically deactivated after 5 seconds.

Peak detection

PEAK

Detection of the maximum weight value during a time interval. Press the key to activate the function. The display shows “-PEAK-” every 5 sec and the transmitter shows the maximum weight reached since the function was activated.

To deactivate the function press the again, the display shows “PEAKoF” for a moment and shows the instantaneous weight again.

By holding down the key it is possible to select in the *P i E . E i n* parameter the minimum time of the pulse duration, expressed in hundredths of a second. The lower this value, the higher the peak function sensitivity.

Converting units of measurement

conUEr

Converting the scale unit of measurement using a free conversion factor. Press the key to convert the weight to pounds. By holding down the key, you can enter a free conversion factor, which will be multiplied by the weight.

Example: to make the display show the cubic meters of water on the scale, enter the value 997 as the conversion factor. The key can be used to switch from the main unit of measurement to the secondary unit at any time.

When the secondary unit of measurement is displayed, the indicator light **F** is lit.

Alibi memory

ALibi

(See section “Alibi memory” page 42).

No function

nonE

No function when the key is pressed.

LEGEND:

- Indicates repeated pressing of the key.
- Parameter visible only under certain conditions.
- Parameter or menu subject to approval.
- Default value of the parameter.

Input configuration

The indicator has 2 configurable inputs (bidirectional optocouplers).

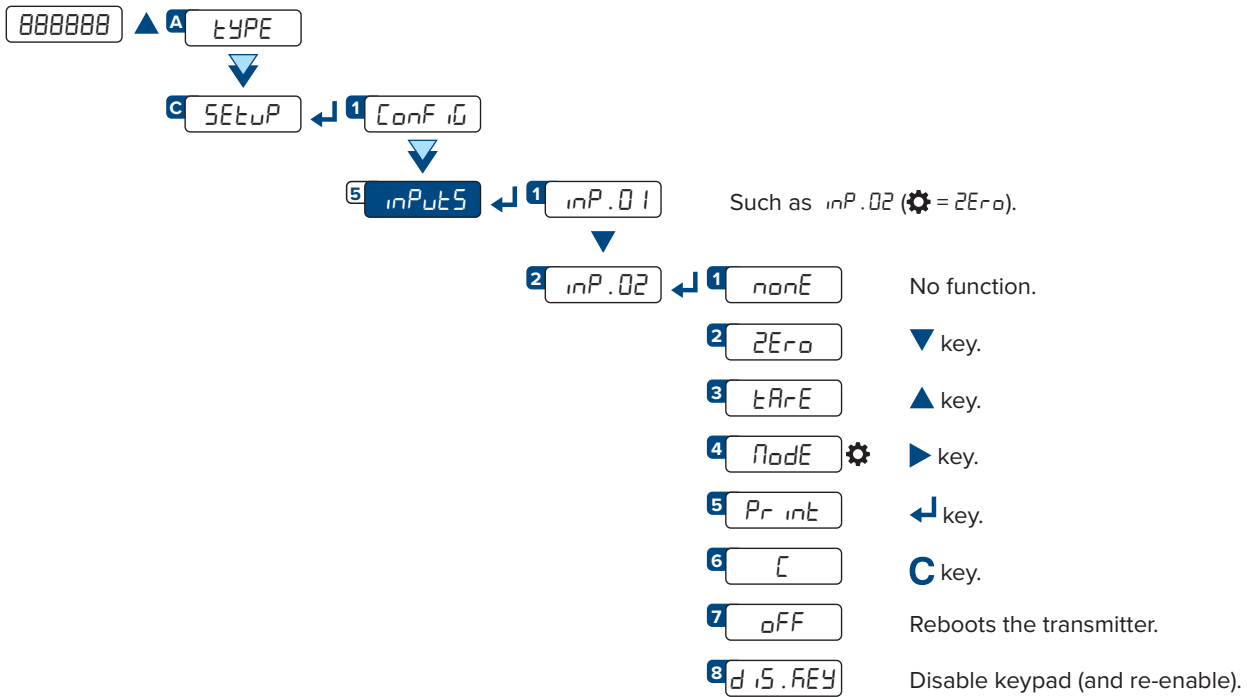

INPUT CONNECTION:

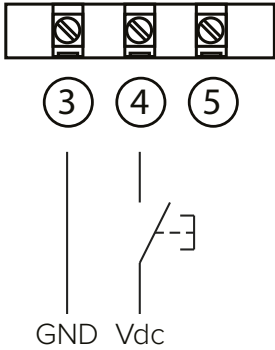

The input is activated when there is a potential difference between terminals 4 - 5 (IN1 and IN2) and terminal 3 (INCOM). The inputs are bidirectional, therefore it is possible to invert GND and Vdc.



Complete menu on pages 24 - 25

MENU ACCESS:

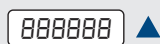

Press the ▲ key during the start-up procedure.

SAVING THE PARAMETERS:

Press the C key several times, until the display shows `SEtUP`. Press the ⬅ key to confirm.



Output configuration

The indicator has 2 programmable outputs (photomosfet).

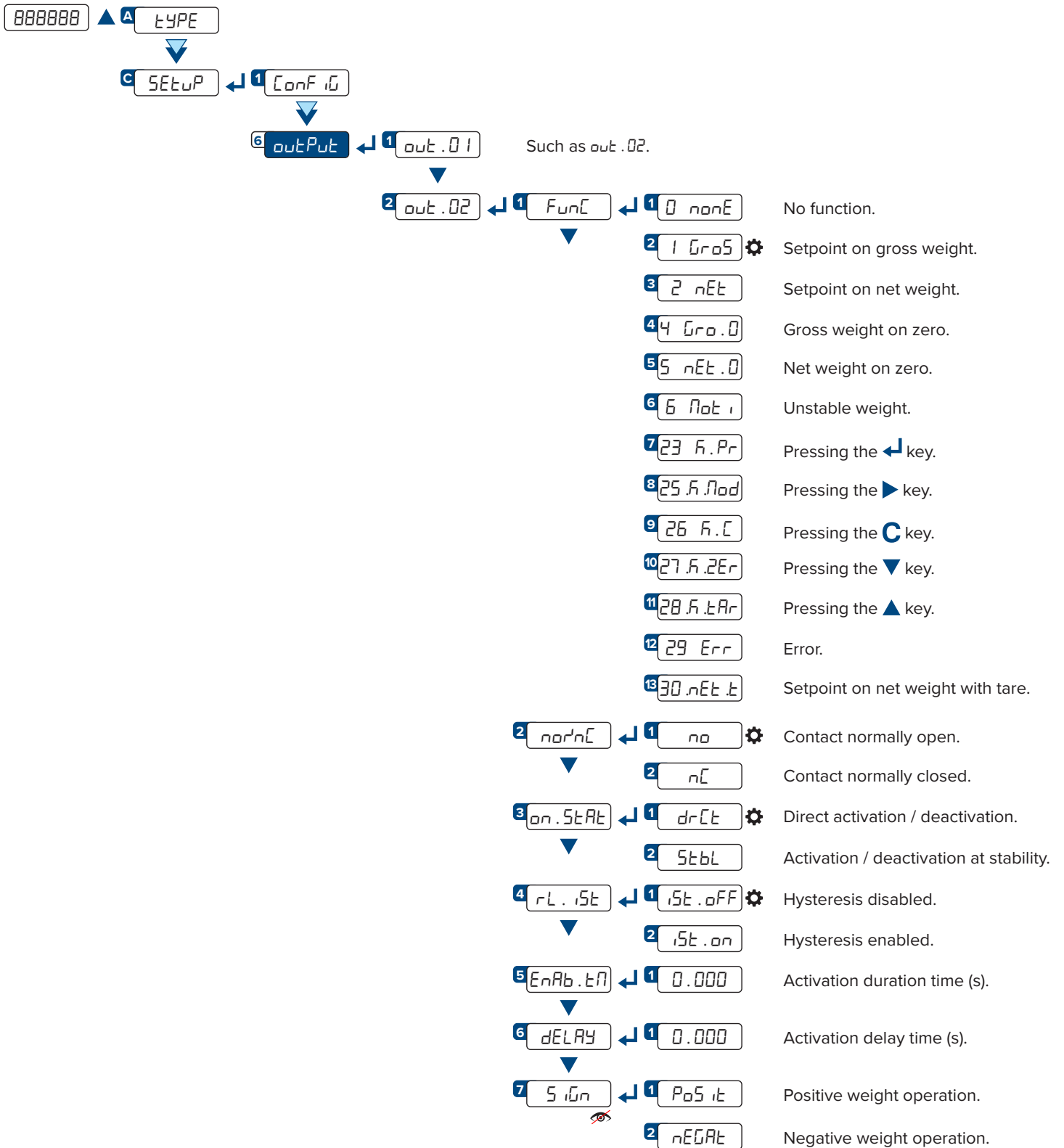

LEGEND:

- Indicates repeated pressing of the key.
- Parameter visible only under certain conditions.
- Parameter or menu subject to approval.
- Default value of the parameter.

Analog output configuration

The DGT4AN model has an analog output in voltage (0 - 5 / 0 - 10 Vdc) or current (4 - 20 / 0 - 20 mA).

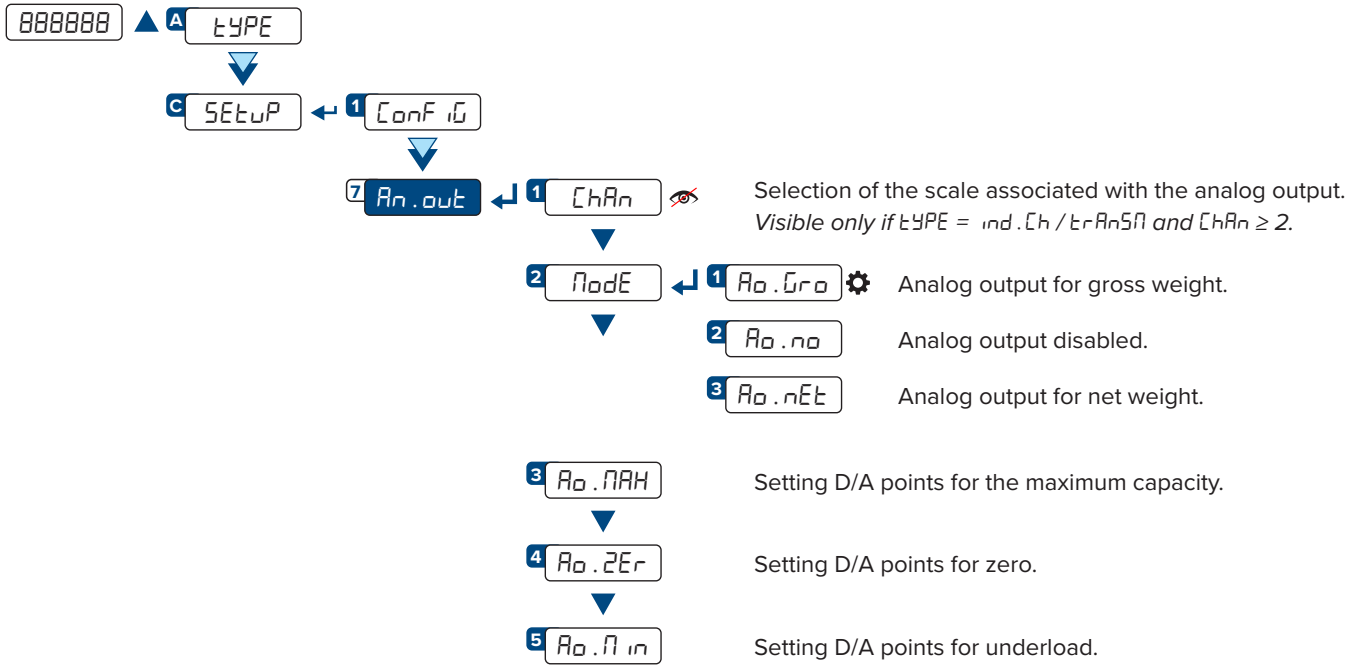

i Voltage or current operation is determined by the connection to the transmitter terminals:

Current: 9 (+) and 10 (-).

Voltage: 11 (+) and 12 (-).

CURRENT ANALOG OUTPUT

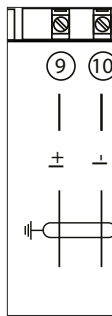

VOLTAGE ANALOG OUTPUT

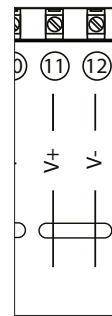

Complete menu on pages
24 - 25

MENU ACCESS:

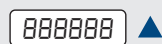

Press the ▲ key during the start-up procedure.

SAVING THE PARAMETERS:

Press the C key several times, until the display shows `5AUEP`. Press the ↵ key to confirm.



CALIBRATION PROCEDURE:

A

Connect a multimeter to the transmitter. Go to the parameter to be changed (R_0 \overline{RAN} , R_0 \overline{ZER} , R_0 \overline{LIN}) and set an approximate value.

Voltage output	Current output
62650 \approx 10 V	58600 \approx 20 mA
0 = 0 V	12700 \approx 4 mA
	0 = 0 mA

B

Press \downarrow to update the output value on the multimeter.

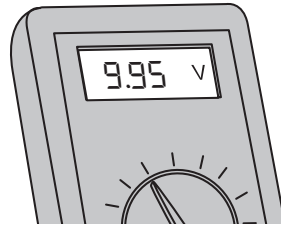

C

Increase or decrease the value to reach the desired output.

100 D/A points \sim 0.015 V / 0.035 mA
 1000 D/A points \sim 0.15 V / 0.34 mA
 10000 D/A points \sim 1.57 V / 3.42 mA

Example:
 Increase $\overline{R_0 \overline{RAN}}$ from 62650 to 62750.

D

Press \downarrow to update the output value on the multimeter.

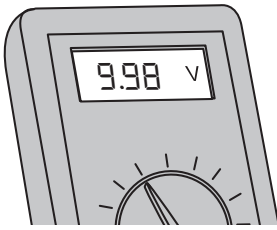

E

Repeat the procedure from point "C" until the desired value is reached, then press \downarrow to save.

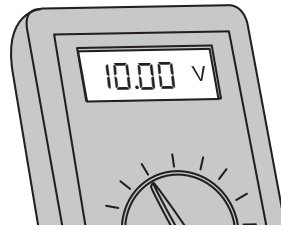

F

Save the changes (press the \overline{C} key several times until you reach the message $\overline{SAVE?}$, then press the \downarrow key to confirm).

ANALOG OUTPUT GRAPH:

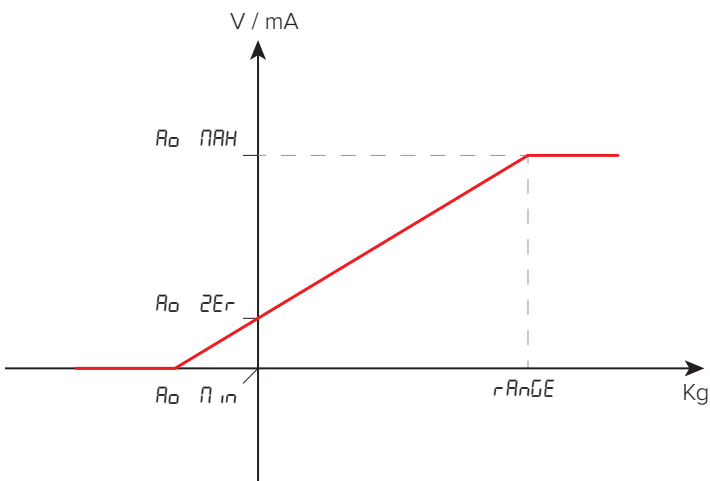

LEGEND:

-  Indicates repeated pressing of the \downarrow key.
-  Parameter visible only under certain conditions.
-  Parameter or menu subject to approval.
-  Default value of the parameter.



Serial communication configuration

The transmitter has 2 serial ports (232 and 485) that can be used indiscriminately to communicate:

- In bidirectional mode with the PC / PLC ("PC" port);
- In one-directional mode with the PC, thermal printer, repeater ("PRN" port);

It is necessary to choose which port to use as PC and, consequently, which one to use as PRN.

Selection of the PC serial port

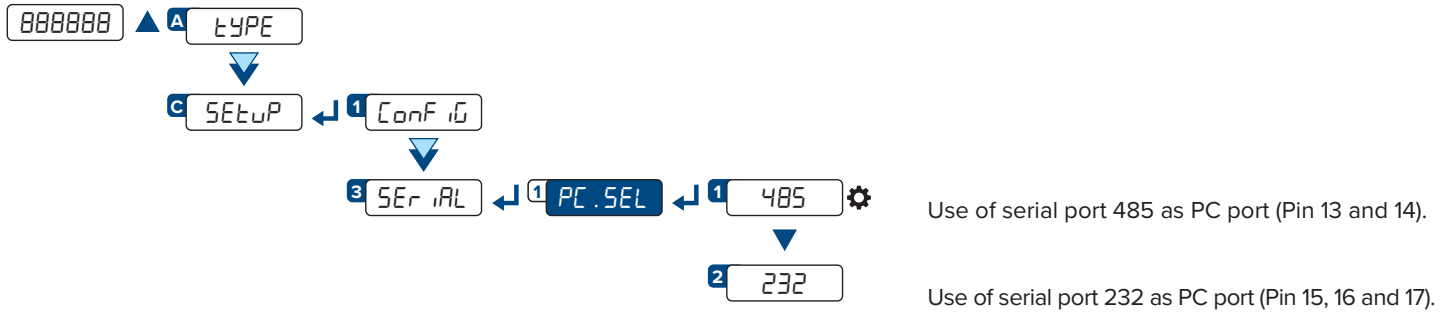

In models DGT4PB, DGT4MODTCP, DGT4ETHCAT, DGT4PRONET, DGT4ETHIP, DGT4DEVNET, DGT4CANOPN, select port 485 as PC port to communicate with the PLC through the built-in fieldbus.



Complete menu on pages
24 - 25

MENU ACCESS:

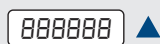

Press the ▲ key during the start-up procedure.

SAVING THE PARAMETERS:

Press the C key several times, until the display shows SETUP. Press the ↵ key to confirm.



Configuration of the printer port (COM.PRN)

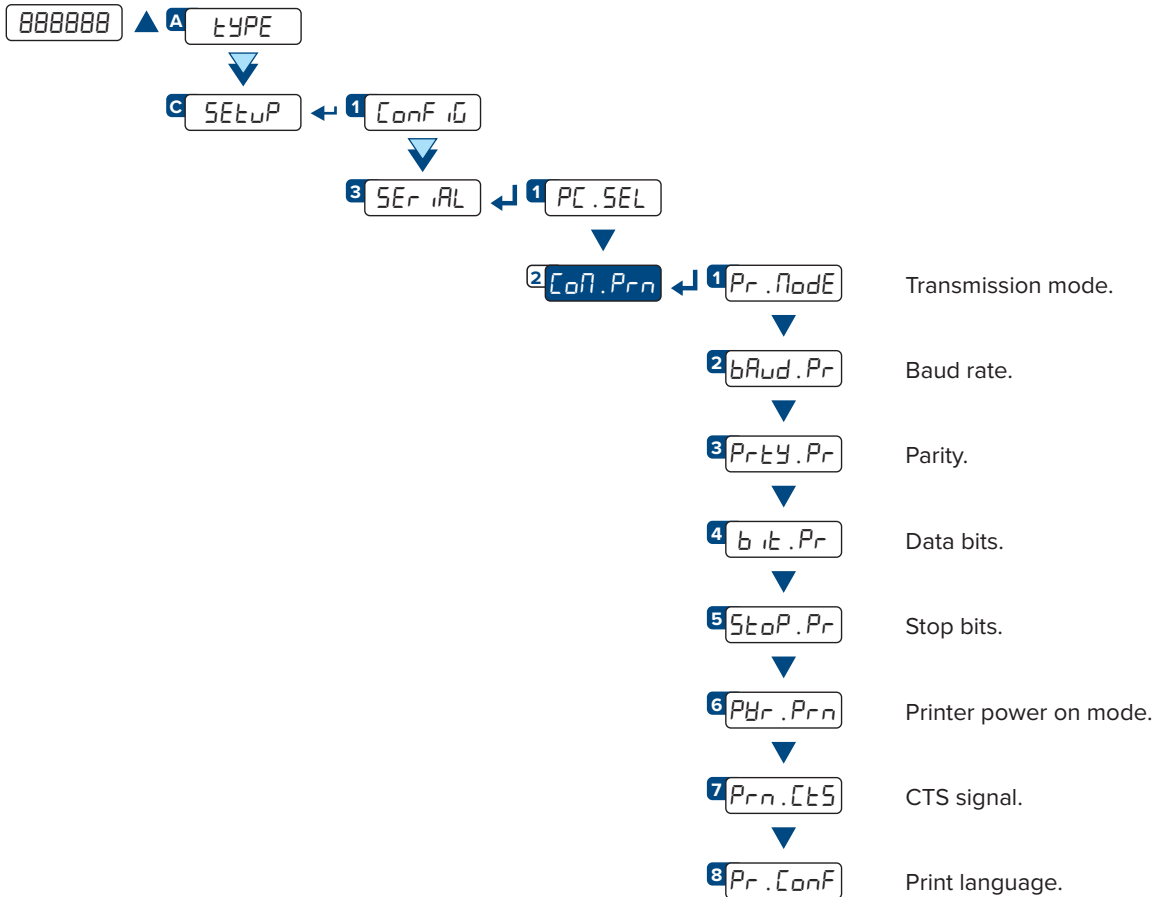

Transmission mode

- 1 Pr .ModE ← 1 Pr-no ⚙️ Transmission not enabled.
- 2 PrPC .hF Transmission of the weight value when the ⏪ key is pressed.
- 3 rEPE .B Transmission of the weight to DINI ARGEO 6-digit repeater.
- 4 PrPC .EH Extended string transmission when the ⏪ key is pressed.
- 5 PrPC .St Standard string transmission when the ⏪ key is pressed.
- 6 ALL .EHt Continuous transmission of the extended string.
- 7 ALL .Std Continuous transmission of the standard string.
- 8 tPr Enables printing on DINI ARGEO printer.

i For the specifications of transmission modes, strings and protocols see the section “TRANSMISSION PROTOCOLS”.

Setting Pr .ModE = rEPE .B automatically sets the serial port to 4800, N-8-1. It is however possible to set it differently.

LEGEND:

- ⏪ Indicates repeated pressing of the ▼ key.
- 👁 Parameter visible only under certain conditions.
- 🔒 Parameter or menu subject to approval.
- ⚙️ Default value of the parameter.

Baud rate, parity, data bits, stop bits

- 2** **bAud.Pr** ← **1** ⚙️
- 2**
- 3**
- 4**
- 5**
- 6**
- 7**
- 8**

- 3** **Prty.Pr** ← **1** ⚙️ No parity, 8 data bits, 1 stop bit.
- 2** Even.
- 3** Odd.

- 4** **bit.Pr** ← **1** ⚙️ 8 bits.
- 2** 7 bits.

- 5** **StoP.Pr** ← **1** ⚙️ 1 stop bits.
- 2** 2 stop bits.

Printer power on mode

It is possible to set the way the printer is turned on:

- 6** **Prn.Prn** ← **1** ⚙️ Printer always on.
- 2** Printer turned on at the time of printing.

CTS signal

On serial port 232 there is the CTS (Clear to send) signal in pin 16.

- 7** **Prn.CtS** ← **1** ⚙️ CTS signal not managed.
- 2** Emulation of the CTS signal.
- 3** CTS signal active high.
- 4** CTS signal active low.

 visible only if $Prn.ModE = tPr$

Print language

- 8** **Prn.ConF** ← **1** ← **1** ⚙️ Italian.
- 2** Spanish.
- 3** French.
- 4** German.
- 5** English.

 visible only if $Prn.ModE = tPr$

i Using the Dinitools software you can configure additional printing parameters.



Complete menu on pages 24 - 25

MENU ACCESS:

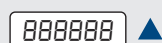

Press the ▲ key during the start-up procedure.

SAVING THE PARAMETERS:

Press the C key several times, until the display shows 5AUEP. Press the ↵ key to confirm.



Reactivation of printing

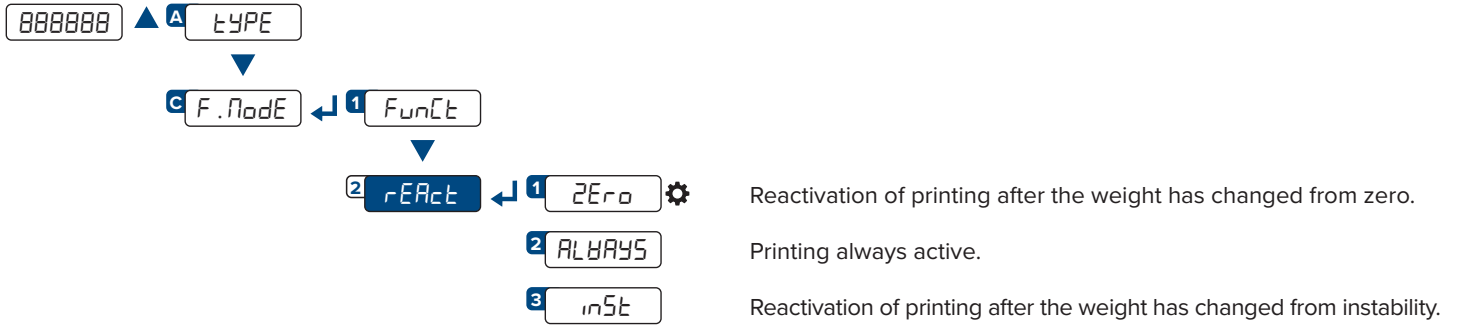

Configuration of the PC port (COM.PC)

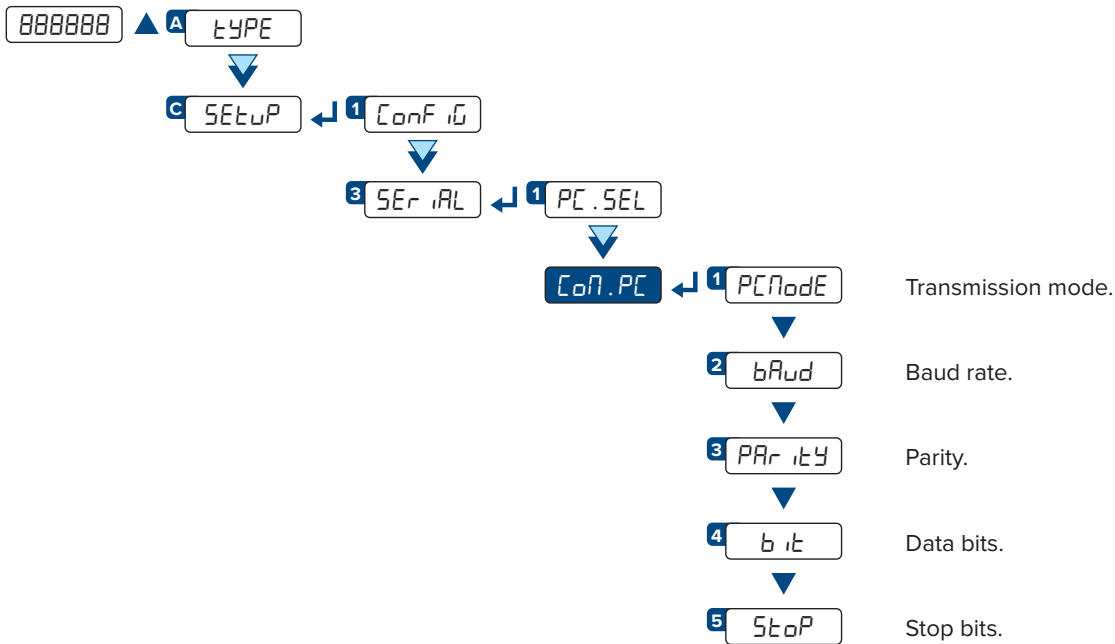

Transmission mode

- 1 PCNoDE ← 1 onDE Transmission on demand.
- 2 rEPE .6 Transmission of the weight on DINI ARGEO 6-digit repeater.
- 3 Pr in .St Standard string transmission when the ← key is pressed.
- 4 Pr in .EH Extended string transmission when the ← key is pressed.
- 5 485 Transmission with 485 protocol (enter the 485 address of the transmitter).
- 6 Modbus ⚙️ Transmission with Modbus protocol (refer to the Modbus protocol manual).
- 7 ALL .NAH Continuous high speed weight transmission for conversion applications (single channel only)
- 8 ALL .Std Continuous transmission of the standard string.
- 9 ALL .EHt Continuous transmission of the extended string.
- 10 StAb .St Stable transmission of the standard string.
- 11 StAb .EHt Stable transmission of the extended string.

LEGEND:

- ⚡ Indicates repeated pressing of the ▼ key.
- 👁 Parameter visible only under certain conditions.
- 🔒 Parameter or menu subject to approval.
- ⚙️ Default value of the parameter.



Baud rate, parity, data bits, stop bits

2 **baud** ← 1 9600 ⚙️

2 4800

3 2400

4 1200

5 115200

6 57600

7 38400

8 19200

3 **PARity** ← 1 nonE ⚙️

No parity, 8 data bits, 1 stop bit.

2 EUEn

Even.

3 odd

Odd.

4 **bit** ← 1 8 ⚙️

8 bits.

2 7

7 bits.

5 **StoP** ← 1 1 ⚙️

1 stop bits.

2 2

2 stop bits.



Complete menu on pages
24 - 25

MENU ACCESS:

888888 ▲

Press the ▲ key during the start-up procedure.

SAVING THE PARAMETERS:

Press the C key several times, until the display shows
SAUEP. Press the ↵ key to confirm.



Standard string

[01]ST,GS, 0.0,kg<CR><LF>

Where:

01	Transmitter code 485 (2 characters), only if communication mode 485 is enabled
ST	Scale status (2 characters): <u>US</u> - Unstable weight <u>ST</u> - Stable weight <u>OL</u> - Weight overload (out of range) <u>UL</u> - Weight underload (out of range)
,	Character ASCII 044
GS	Type of weight data (2 characters) <u>GS</u> - Gross <u>NT</u> - Net <u>VL</u> - Microvolts <u>RZ</u> - Converter points
,	Character ASCII 044
0.0	Weight (8 characters including the decimal point)
,	Character ASCII 044
kg	Unit of measurement (2 characters)
<CR><LF>	Transmission terminator, characters ASCII 013 and ASCII 010

Extended string

[01]1ST,1, 0.0,PT 20.8, 0,kg,01/02/19 11:12:13<CR><LF>

Where:

01	Transmitter code 485 (2 characters), only if communication mode 485 is enabled
1	Number of the active scale
ST	Scale status (2 characters): <u>US</u> - Unstable weight <u>ST</u> - Stable weight <u>OL</u> - Weight overload (out of range) <u>UL</u> - Weight underload (out of range)
,	Character ASCII 044
0.0	Weight (8 characters including the decimal point)
,	Character ASCII 044
PT	Preset tare indication
20.8	Tare (8 characters including the decimal point)
,	Character ASCII 044
0	Character ASCII 048
,	Character ASCII 044
kg	Unit of measurement (2 characters)
,	Character ASCII 044
01/02/19 11:12:13	dd/mm/yy hh:mm:ss (only with REXD command and optional clock card)
<CR><LF>	Transmission terminator, characters ASCII 013 and ASCII 010

[01]ST, 612,kg,ST, 61.4,t,ST, 6.17,g,ST, 0.617,lb

Where:

01	Transmitter code 485 (2 characters), only if communication mode 485 is enabled
ST	Scale 1 status (2 characters): <u>US</u> - Unstable weight <u>ST</u> - Stable weight <u>VL</u> - Microvolts <u>RZ</u> - Converter points , Character ASCII 044
612	Scale 1 weight (8 characters including the decimal point) , Character ASCII 044
kg	Scale 1 unit of measurement (2 characters) , Character ASCII 044
ST	Scale 2 status (2 characters): <u>US</u> - Unstable weight <u>ST</u> - Stable weight <u>VL</u> - Microvolts <u>RZ</u> - Converter points , Character ASCII 044
61.4	Scale 2 weight (8 characters including the decimal point) , Character ASCII 044
t	Scale 2 unit of measurement (2 characters) , Character ASCII 044
ST	Scale 3 status (2 characters): <u>US</u> - Unstable weight <u>ST</u> - Stable weight <u>VL</u> - Microvolts <u>RZ</u> - Converter points , Character ASCII 044
6.17	Scale 3 weight (8 characters including the decimal point) , Character ASCII 044
g	Scale 3 unit of measurement (2 characters) , Character ASCII 044
ST	Scale 4 status (2 characters): <u>US</u> - Unstable weight <u>ST</u> - Stable weight <u>VL</u> - Microvolts <u>RZ</u> - Converter points , Character ASCII 044
0,617	Scale 4 weight (8 characters including the decimal point) , Character ASCII 044
lb	Scale 4 unit of measurement (2 characters)
<CR><LF>	Transmission terminator, characters ASCII 013 and ASCII 010

Serial commands

By selecting the PC port on demand mode (*andE*), you can communicate with the transmitter via serial commands. For each command received, the transmitter emits a string containing the response (refer to the command description) or one of the following signals:

OK<CRLF>	Command sent when sending a correct command. This response does not imply that the command is executed.
ERR01<CRLF>	Command sent correctly but followed by letters entered unintentionally (e.g. READF, TARES).
ERR02<CRLF>	Incorrect command data.
ERR03<CRLF>	Command sent not allowed (transmitter busy, or not used in the selected operating mode).
ERR04<CRLF>	Command sent non-existent.

i If the 485 protocol has been selected, you must precede the command with the transmitter address (e.g. 01READ).

WEIGHT READING (standard string)

Format	R E A D
Response	Standard string.

READING OF THE EXTENDED OR MULTI-SCALE WEIGHT (if *TYPE = trAnSn*)

Format	R E X T
Response	Extended string.

WEIGHT READING IN HIGH RESOLUTION (X10)

Format	G R 1 0
Response	Standard string with weight in resolution x10.

AUTOMATIC TARE

Format	T A R E
Response	OK (or ERRxx).

MANUAL TARE

Format	T M A N t t t t t t
Where	ttttt tare value
Response	OK (or ERRxx).

ZEROING (of active channel)

Format	Z E R O
Response	OK (or ERRxx).

By entering a manual tare value of 0, the tare on the scale is cleared.

DISABLING KEYPAD

Format	K E Y E D
Response	OK (or ERRxx).

ENABLING KEYPAD

Format	K E Y E E
Response	OK (or ERRxx).

READING INPUTS

Format	I N P U n
Where	n Input (1 / 2).
Response	I N P U n v v v v
Where	n Input number. vvv Input status: 0000 = Not active. 0001 = Active. FFFF = Input reading error.

READING OUTPUTS

Format	O U T S n
Where	n Output (1 / 2).
Response	O U T S n v v v v
Where	n Output number. vvv Output status: 0000 = Not active. 0001 = Active. FFFF = Output reading error.

PRESSING A KEY

Format	K	E	Y	P	x	x
Where	xx	Key code.				
	00	▼				
	01	▲				
	02	▶				
	03	↵				
	04	C				

Response	OK (or ERRxx).
----------	----------------



To simulate pressing a key, you must send the KEYP and KEYR commands in succession. If more than 1.5 s pass after the KEYP command is sent, the transmitter will execute the function associated with prolonged pressing of the key.

RELEASING A KEY

Format	K	E	Y	R
--------	---	---	---	---

Response	OK (or ERRxx).
----------	----------------

BRIDGE BETWEEN THE SERIAL PORTS

Format	B	R	I	D	G	E	1
--------	---	---	---	---	---	---	---

Response	OK (or ERRxx).
----------	----------------

SCALE INFORMATION

Format	R	A	L	L
--------	---	---	---	---

Response	s	s	,	b	,	N	N	N	N	N	N	u	u	,	L	L	L	L	L	L	u	u	,		
	Y	Y	T	T	T	T	T	T	T	T	u	u	,	S	S	S	,	A	A	A	,	C	C	C	C
	,	,	R	R	R	R	R	-	I	I	I	I	I	I											

Where	ss	UL = Underload. OL = Overload. ST = Stable weight. US = Unstable weight.
	b	Number of the active scale.
	NNNNNNuu	Net weight with unit of measurement.
	LLLLLuu	Gross weight with unit of measurement.
	YY	PT if a manual tare is present or “ ”.
	TTTTTuu	Tare with unit of measurement.
	SSS	Scale status: 000 = scale weighing. 001 = entering a numerical value. 002 = scale in technical menu.
	AAA	Counter keys pressed: 0001 = ▼ 0002 = ▲ 0003 = ▶ 0004 = ↵ 0170 = C
	CCCC	Code of last key pressed.
	RRRRR	Last rewrite number saved to Alibi memory.
	IIIIII	Last ID number saved to Alibi memory.

READING OF MICROVOLTS

Format	M	V	O	L
Response	Standard string.			

READING OF CONVERTER POINTS

Format	R	A	Z	F
Response	Standard string.			

INITIALISING ALIBI MEMORY

Format	A	L	D	L
Response	ALDLOK / ALDLNO			

WEIGHT READING WITH DATE AND TIME

Format	R	E	X	D
Response	Extended string.			

READING A WEIGHING OPERATION IN THE ALIBI MEMORY

Format	A	L	R	D	X	X	X	X	X	-	Y	Y	Y	Y	Y	Y
Response	b	,	L	L	L	L	L	L	L	L	L	L	u	u	,	
	Y	Y	T	T	T	T	T	T	T	T	T	T	u	u		
Where	b		Scale number.													
	LLLLLLLLLuu		Gross weight with unit of measurement.													
	YY		"PT if a manual tare is present or " ".													
	TTTTTTTTTuu		Tare with unit of measurement.													

SAVING A WEIGHING OPERATION IN THE ALIBI MEMORY

Format	P	I	D																				
Response	P	I	D	S	T	,	b	,	L	L	L	L	L	L	L	L	L	L	u	u	,	Y	Y
	T	T	T	T	T	T	T	T	T	T	u	u	,	X	X	X	X	X	-	Y	Y	Y	Y
	Y	Y																					
Where	b		Scale number.																				
	LLLLLLLLLuu		Gross weight with unit of measurement.																				
	YY		"PT if a manual tare is present or " ".																				
	TTTTTTTTTuu		Tare with unit of measurement.																				
	XXXXXX		Rewrite number.																				
	YYYYYY		ID number.																				

i The alibi memory commands are executed only if $F_{unc} = AL_{ib}$.

In TRANSM mode, if the commands "ZERO", "TARE" and "TMAN" are followed by "X", the command is executed only on the indicated scale. For example:

Format	T	A	R	E	,	X
Where	X		Scale: 0 = scale 1 1 = scale 2 2 = scale 3 3 = scale 4			
Response	OK (or ERRxx).v					

Format	Z	E	R	O	,	X
Where	X		Scale: 0 = scale 1 1 = scale 2 2 = scale 3 3 = scale 4			
Response	OK (or ERRxx).v					

b The Modbus protocol and the Fieldbus protocols are described in the respective manuals.

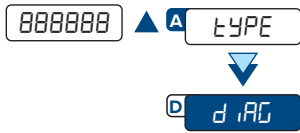

Cells / converter test

4 **RdC . uV**

Display of the μV related to the weight on the scale.

Use the ▲ and ▼ keys to display the different channels (in dEP . Ch mode the sum is also visible).

For correct operation, the value of the μV of each channel must be less than 30000 with a weight equal to the maximum capacity. This value must be stable, and increase if a load is applied to the cell.

5 **RdC . Pnt**

Display of the A/D points of the converter related to the weight on the scale.

Use the ▲ and ▼ keys to display the different channels (in dEP . Ch mode the sum is also visible).

For correct operation, the value of A/D points must be stable, and increase if a load is applied to the cell.

Firmware release

1 **PrG . UEr**

Display of firmware release (e.g. 08 . 04 . 00).

Serial number

15 **SEr . nuM**

Display of transmitter serial number.

Display

8 **d ISPLA**

Activation of all display segments and indicators.

Keypad

9 **FEYb**

The code of last key pressed is shown on the display:

▼	8001
▲	8002
▶	8003
↶	8004
C	80AA

Press the same key 3 consecutive times to exit.

Serial ports

10 `SER` Bridge between serial ports (for manufacturer's use).

CTS signal

11 `CTS.St.` Checking the CTS signal of the printer (on) connected to the PRN port.

Inputs

13 `INPUTS` Checking the status of the inputs:
value 0 indicates that the input is disabled, value 1 indicates that the input is enabled.
Use the ▲ and ▼ keys to display the two inputs.

Outputs

12 `OUTPUT` Activation of the output shown on the display (rEL.1 / rEL.2).
Use the ▲ and ▼ keys to activate the two outputs.

Analog output

14 `An.out` Analog output test.
Use the ▲, ▼, ► keys to enter the D/A point value of the analog output.
Press the ◀ key to confirm and update the V / mA value of the analog output.

Programming the Setpoints

In weighing mode, if the output functions (1 Gross / 2 net) have been set correctly, pressing ◀ for 3 seconds will enter the setpoint programming menu:

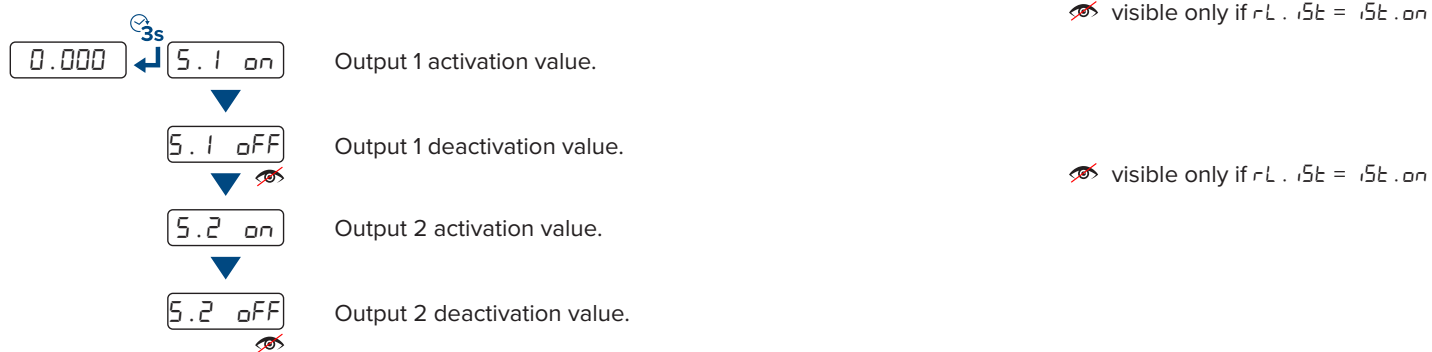

Once you have entered the desired values, press C. The display shows “5tarE” and returns to weighing mode.

Restoring factory settings

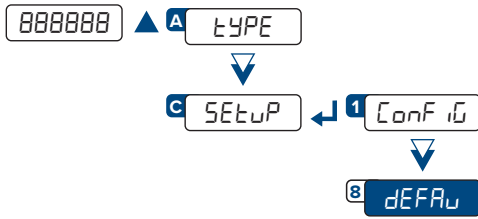

The transmitter is initialized and the default parameters (indicated by the ⚙️ symbol) are activated. Pressing the display shows “dFLtP” confirm further with or exit by pressing another key.

The actual activation of the default parameters is performed by saving the settings (SAVEP) while exiting the menu.

Date and time setting

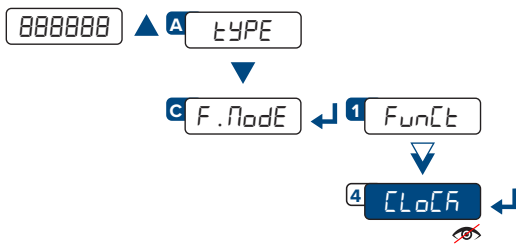

Visible only with optional clock card

- Set the day and press .
- Set the month and press .
- Set the year (with two digits) and press .
- Set the hour and press . The time format is 24h.
- Set the minutes and press .



The date and time format is: DD/MM/YY, HH:MM:SS (24h),

Alarm	Description		
<i>P r E C</i>	Displayed if you try to calibrate a point without first confirming the number of calibration points (<i>n t P</i>).		
<i>E r . N o t</i>	Calibration error: unstable weight during point acquisition.		
<i>E r P n t</i>	Calibration error: during the acquisition of a calibration point a NULL value was read from the converter.		
<i>E r r . H . 1</i>	Error that occurs if the capacity of channel <i>H</i> is not set, or there is an error in the calibration parameters of channel <i>H</i> , where <i>H</i> indicates the number of the channel to which the error refers.		
<i>a U E r H</i>	Error that occurs if the capacity of channel <i>H</i> is not set, or there is an error in the calibration parameters of channel <i>H</i> , where <i>H</i> indicates the number of the channel to which the error refers.		
<i>E r 11</i>	Calibration error: a sample weight that is too low was used; it is recommended to use a weight of at least half the scale's capacity.		
<i>E r 12</i>	Calibration error: The acquired calibration point (<i>t P 1 / t P 2 / t P 3</i>) is equal to the zero point (<i>t P 0</i>).		
<i>E r 37</i>	Scale to be calibrated (we recommend resetting the transmitter to the factory default "dEFAU" settings before proceeding).		
<i>E r 39</i>	Scale to be calibrated (we recommend resetting the transmitter to the factory default "dEFAU" settings before proceeding).		
<i>E . E r . -35</i>	Negative internal points were calculated during calibration: <ul style="list-style-type: none"> the calibration point is below the zero point; The signal is negative (check the connections). 		
<i>E . E r . -37</i>	Internal points below the minimum value were calculated during calibration: <ul style="list-style-type: none"> the calibration point is equal to the zero point; too high a capacity has been set with respect to the division. 		
<i>h b . E r r</i>	Hardware error: software not compatible with the installed hardware.		
<i>R L . E r r</i>	Displayed when the alibi memory is enabled and the transmitter does not detect the presence of the card when the power is turned on. The <i>E o n U</i> function is set automatically, but not saved in the setup environment.		
<i>b u S Y</i>	Printing in progress (printer serial port busy) or transmitter waiting to transmit a print to PC.		
<i>u n S t A b</i>	You are trying to print with an unstable weight.		
<i>u n . a U E r</i>	You are trying to print with the weight in underload or overload.		
-----	The weight is overloaded (9 divisions over the maximum capacity).		
-----	The weight is underloaded. <table border="1" style="margin-left: 20px;"> <tr> <td>Approved instrument: -9 divisions.</td> </tr> <tr> <td>Non-approved instrument: -100 divisions.</td> </tr> </table>	Approved instrument: -9 divisions.	Non-approved instrument: -100 divisions.
Approved instrument: -9 divisions.			
Non-approved instrument: -100 divisions.			
<i>G r o S . E r</i>	You are trying to print with a non-positive gross weight (less than or equal to zero).		
<i>n E r . E r r</i>	You are trying to print with a non-positive net weight (less than or equal to zero).		
<i>L o t</i>	Net weight less than the minimum weight required for printing.		
<i>n o . 0 . u n S</i>	Weight not passed by net 0 or instability.		
<i>E o n U</i>	You are trying to print while the transmitter is converting the unit of measurement.		
<i>E r r . C L K</i>	Communication problems with the clock card of the transmitter.		

Notes

This publication, or any part of it, may not be reproduced without written permission from the Manufacturer. All information in this manual is based on the data available at the time of its publication; the Manufacturer reserves the right to make changes to its products at any time, without notice and without incurring any penalty. We therefore recommend that you always check for updates. The person responsible for the use of the scale must ensure that all safety regulations in force in the country of use are applied, ensure that the scale is employed in accordance with the intended use and avoid any dangerous situation for the user. The Manufacturer declines all responsibility for any weighing errors.





A RICE LAKE WEIGHING SYSTEMS COMPANY

HEAD OFFICE

Via Della Fisica, 20
41042 Spezzano di Fiorano, Modena - Italy
Tel. +39 0536 843418 - Fax +39 0536 843521

SERVICE ASSISTANCE

Via Dell'Elettronica, 15
41042 Spezzano di Fiorano, Modena - Italy
Tel. +39 0536 921784 - Fax +39 0536 926654

www.diniargeo.com

Stamp of the authorized service center

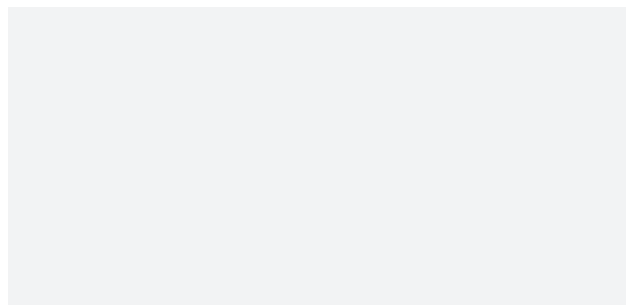

The information in this document is approximate and can be subject to variations without prior notice by Dini Argeo. In compliance with the norms in force, the official technical data are available in the updated version on the following website www.diniargeo.com or by contacting Dini Argeo Customer Service.

TECH_MAN_ENG_DGT4_V8
Rev.05.11.2020