

Tuning Fork Analytical Balance

HT/HTR-CE Series

Operation Manual

IMPORTANT

- To ensure safe and proper use of the balance, please read this manual carefully.
- After reading this manual, store it in a safe place near the balance, so you can review it as needed.

SHINKO DENSHI CO., LTD.

PREFACE

Thank you for purchasing an HT/HTR Series electronic balance.

The HT/HTR Series is a new balance equipped with a high-precision tuning fork sensor mechanism. Its windshield is made of antistatic plastic, helping to reduce its weight, and the balance is equipped with a variety of functions such as parts counting, percentage weighing, gravimeter and limit functions that are helpful in weighing fixed amounts. This multifunctional balance employs a user-friendly program, and the keys are arranged in a way that makes the balance easy to operate. In addition, the fluorescent display is eye-friendly, and the balance's high-speed and stable performance improves your work efficiency.

Check for the following accessories before use.

If any items are found to be missing or damaged, immediately contact local dealer.

(1) Main Unit

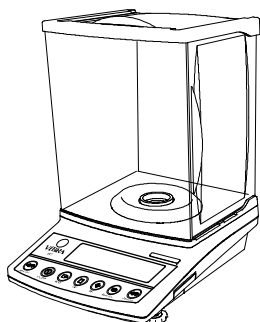

(2) Pan Base



(3) Pan



(4) AC adapter

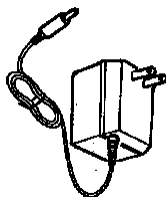

(5) Operation manual



Contents

Contents.....	1	10 Unit Converting.....	27
1 Precautions Relating to Use.....	3	11 Gravimeter.....	28
2 Names of Component Parts.....	7	11.1 Measurement procedures for specific gravity.....	28
2.1 Main Unit.....	7	11.2 Entering water temperature or the specific gravity of the media .	30
2.2 Operation Keys.....	8	12 Addition Function.....	32
2.3 Displayed Signs.....	9	12.1 Cumulate Function.....	32
3 Installation of the Balance.....	10	12.2 Net Addition Function.....	33
4 Basic Operation.....	11	13 Limit Function.....	35
4.1 Power On/Off.....	11	13.1 Setting the Limit Function.....	35
4.2 Weighing.....	11	13.2 Judgment and Saving.....	35
4.3 Zero Adjustment.....	11	13.3 Display of Judgment Results.....	35
4.4 Tare (pan).....	11	13.4 Judge by Absolute Values.....	36
4.5 Set a Gross Weight.....	12	13.5 Judge by Deviation Values.....	39
4.6 Single-touch Response Setting .	12	13.6 Bar Graph for the 2-point Scale .	43
4.7 Data Output.....	13	14 Calibration and Span Test for the Balance.....	44
4.8 Hanging Measurement.....	13	14.1 Span Adjustment with Built-In Weights.....	44
5 Function 1.....	15	14.2 Span Adjustment with External Weight.....	44
5.1 Setting and Check.....	15	14.3 Span Test with Built-In Weights .	45
5.2 Description of Function 1.....	16	14.4 Span Test with External Weight .	45
5.3 Specific Gravity Setting.....	19	14.5 Calibration of Built-In Weights	45
5.4 Limit/Addition Functions.....	19	14.6 Entry of Weight Error.....	47
5.5 Interface.....	20	14.7 Advice CAL and Full-automatic Span Adjustment.....	48
6 Function 2.....	21	14.8 Auto Repeatability Measurement (ARM).....	48
6.1 Calling and Setting.....	21	15 Date and Time Setup.....	49
6.2 Description of Function 2.....	21	15.1 Time Setup.....	49
7 Weighing and Measurement Modes.....	22	15.2 Date Setup.....	49
7.1 Weighing and Measurement Modes.....	22	16 Various Functions.....	50
7.2 Weighing Machine.....	22	16.1 Auto Backlight OFF.....	50
8 Parts Counting.....	23	16.2 Set Unit.....	50
9 Percentage Weighing.....	25	16.3 Date Display.....	50
9.1 Set a reference weight by weighing an actual sample.....	25	16.4 Time Stamp Output.....	50
9.2 Set a reference weight by entering a value.....	26	16.5 Direct Start.....	50
		16.6 Interval Output Function.....	51
		16.7 Input of ID No.	52

17	Input/Output Functions.....	53	19	Output in Compliance with ISO/GLP/GMP	70
17.1	RS232C Output.....	53	20	Removing the Windshield Door	73
17.2	Output to Peripherals.....	56	20.1	Removing the Windshield Door..	73
17.3	Type of Communication Texts ...	57	20.2	Caring for the balance	73
17.4	Output Data.....	57	21	Troubleshooting	74
17.5	Input Commands.....	61	22	Specifications.....	75
17.6	Special Format Output.....	67	22.1	Basic Specifications	75
18	Use Printers	69	22.2	Weighing Capacity and Minimum Readability by Unit.....	76
18.1	Setting up the Printer	69	23	Unit Conversion Table	77
18.2	Outputting calibration results	69			
18.3	Output of Measurement Data in Compliance with ISO/GLP/GMP	69			

1 Precautions Relating to Use

- This Section “Precautions Relating to Use” sets forth precautionary notes that the user should observe in order to prevent physical injury to the user and/or damage to property.
- The nature of problems that may result in the event of improper operation, and consequential effects on the quality and performance of the balance, are indicated under the two categories of “Caution” and “Recommended,” and explained using symbols.



Caution

This is a category to indicate improper handling that may cause physical injury or severe damage to property. Be sure to follow the directions for safe use to avoid serious consequences.

Recommended

This term indicates steps that the user should take to ensure the quality and reliability of the balance.

Meanings of Symbols

Each symbol is accompanied by an instruction.



Mandatory Symbol

Indicates a “mandatory” action that should be executed without fail.

Example



Check Level



Prohibitive Symbol

Indicates a “prohibited” action that must not be executed.

Example



Do Not Use



Caution!



Do Not Disassemble



◆ **Do not disassemble or modify the unit.**

- Could cause malfunction.
- In case of malfunction do not disassemble the unit. Contact our local dealer.



Do Not Deviate from Ratings

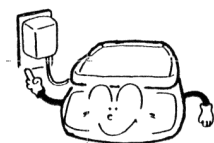

◆ **Only AC power should be used.**

◆ **Only use the dedicated AC adapter.**

- Use of other types of power or adapters may result in heat generation or malfunction of the balance.



Do Not Move



◆ **Do not move the balance when a sample is loaded.**

- The loaded sample may fall off the pan and cause an injury.



Do Not Use

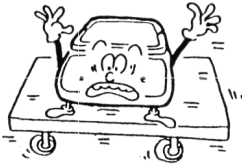

◆ **Do not place the balance on an unstable base or use the balance in a location where it may be subjected to shock.**

- The loaded sample may fall off the pan.
- Accurate measurement may be rendered impossible.



Do Not Drop



◆ **Do not lay the AC adapter cable on the surface of the passage.**

- Somebody may trip on the cable, causing the balance to fall off, thereby causing injury and/or damage to the balance.



Do Not Leave Afloat



◆ **Do not use the balance with its adjusters lifted.**

- The balance will become unstable, preventing accurate measurement.



Do Not Touch with Wet Hand

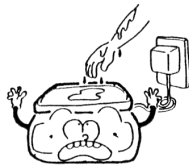

◆ **Do not touch the AC adapter or the balance with wet hands.**

- Could result in an electrical shock.



Do Not Expose to Water



◆ **Do not expose the balance to rain or water.**

- Could cause an electrical shock or short circuit.
- The balance will corrode and malfunction.















Do Not Expose to Dust

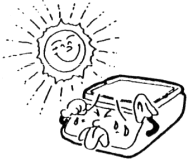

◆ **Do not use the balance in a dusty environment.**

- Could cause an explosion or fire.
- Could cause a short circuit or interfere with the balance's electrical conductivity, causing it to malfunction.

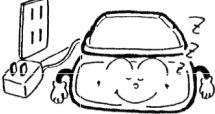
Recommended

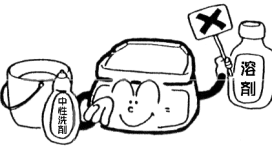
 Calibrate Balance		<ul style="list-style-type: none"> ◆ Calibrate the balance after installation or relocation. • Measurement values may contain errors, preventing accurate measurement from being conducted.
 Do Not Apply Force		<ul style="list-style-type: none"> ◆ Avoid applying excess force or impact to the balance. • Place the sample to be measured on the balance carefully to prevent breakage or malfunction.
 Do Not Use		<ul style="list-style-type: none"> ◆ Do not use the balance in a location where it may be subjected to abrupt changes in ambient temperature or humidity. • Accurate measurement may be rendered impossible. • Use the balance in an ambient temperature range of 10°C to 30°C and with 80% or lower relative humidity.
 Do Not Overload		<ul style="list-style-type: none"> ◆ Do not leave the balance overloaded. (When it is overloaded, (o-Err) is displayed.) • Take down the loaded sample immediately to prevent breakage or malfunction.
 Do Not Use		<ul style="list-style-type: none"> ◆ Do not use the balance in a location where it is subject to direct sunlight. • The indications would be illegible. • An internal temperature increase in the balance may lead to inaccurate measurement.
 Unplug Adapter		<ul style="list-style-type: none"> ◆ If the balance is to be unused for an extended period of time, unplug the adapter. • This conserves power and prevents deterioration.
 Do Not Use		<ul style="list-style-type: none"> ◆ Do not use volatile solvents for cleaning. • The body may be distorted. • To clean the unit of stains, use a piece of dry cloth or cloth soaked in a small quantity of neutral detergent.



Do Not Use

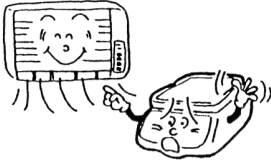

◆ **Do not use the balance in a location where it may be subject to air from an air-conditioning unit.**

- Extreme changes in the ambient temperature may result in inaccurate measurements.



Do Not Use



◆ **Do not use the balance on a soft floor.**

- When loaded with a sample, the balance may tip or move, preventing accurate measurements from being conducted.



Check Level

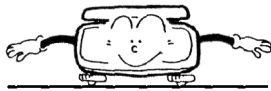

◆ **Do not use the balance when it is tilted.**

- When the balance is tilted, an error may be caused, preventing accurate measurement from being conducted. Place the balance on a level surface.





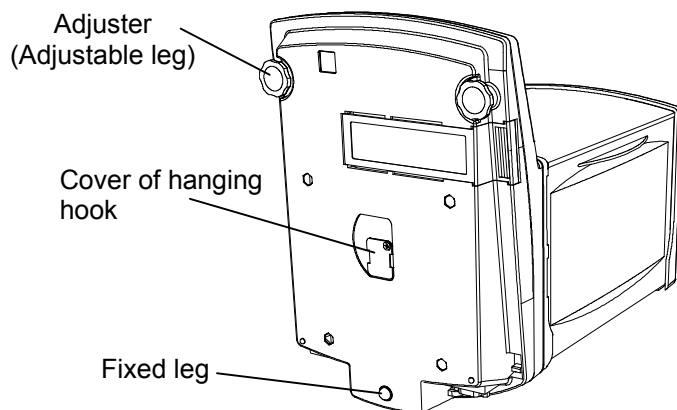
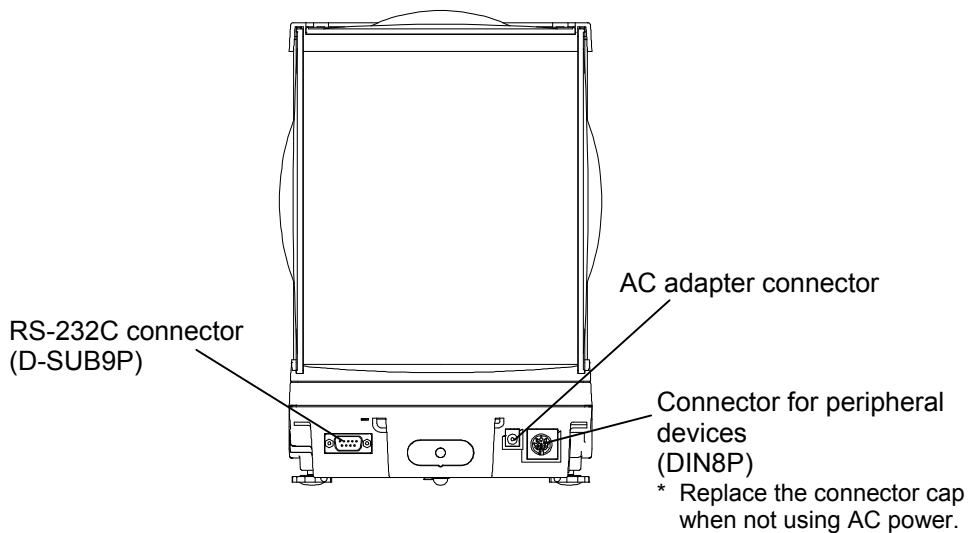
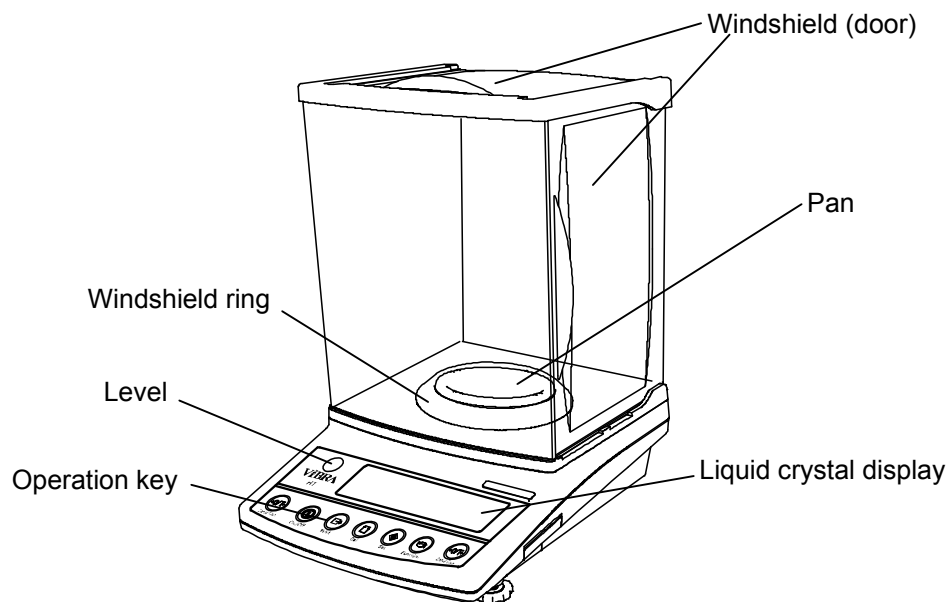





2 Names of Component Parts

2.1 Main Unit



2.2 Operation Keys

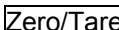

Operation key		Function
	 On/Off key	Turns the balance on or off.
	 Print key	Starts output. Pauses the setting and input operation.
	 Cal key	[Short press] Switches to the span adjustment and span test modes. [Continuous press] Starts automatically repeatable measurements.
	 Set key	[Short press] Toggles the response mode. [Short press] Stores the settings.
	 Function key	[Short press] Toggles the weighing modes. [Short press] Used to enter numerical values. [Short press] Used to select a function to set. [Continuous press] Calls functions.
	 Zero/Tare key	[Short press] Used for zero-setting or sets the display to zero by tare range. [Short press] Used to enter numerical values. [Short press] Used to select a function.

2.3 Displayed Signs



2.3.1 Displayed signs

Display	Description
	Displays the judgment results when the (five-point) limit function is enabled.
*	Displayed when the balance is in standby mode. Indicates that the addition function is enabled for accepting an additional load.
○	Indication of stable balance (If this light is off, the balance is unstable.)
+	Sign for sample addition when parts counting is performed
—	Minus
M	Display of set values from memory (If it is flashing, the value is being saved.)
→0←	Zero-point
	Bar graph (Refer to Hints on page 43).
CAL	Displayed when calibration and Advice CAL are enabled.
	Lights up when date/time is being set or displayed. Blinks during interval output.
	Displayed when data is output in compliance with ISO/GLP/GMP.
B/G	Gross weight
Net	Tare sign
#	Unit converting
Σ	Displays a sum total.
Pcs	Parts counting
mom	Momme
%	Percentage weighing
	Displays the selected unit.
mg	Milligram, gram
	Displayed according to the function.
	Lights up only when the auxiliary scale interval is being displayed.

3 Installation of the Balance

1. Attach the pan base and pan.

Attach the pan base and pan to the main unit as shown in the figure.

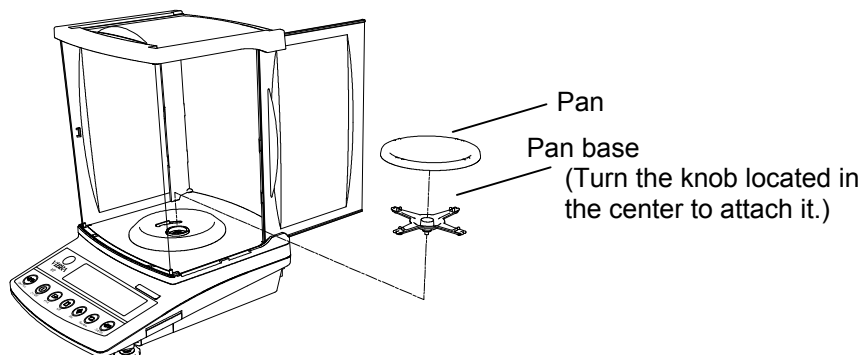

2. Level the Balance.

Turn the adjuster so that the air bubble in the level gauge is within the circle.

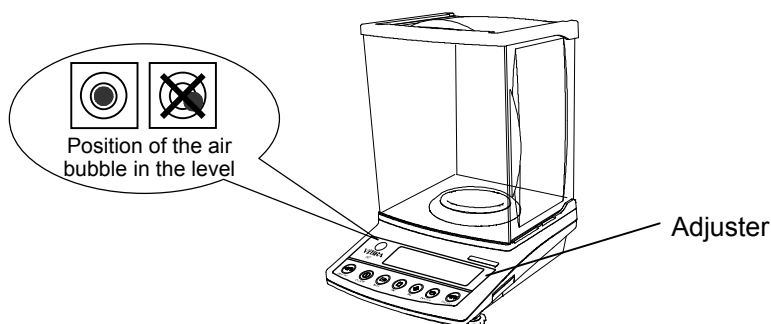

3. Connect the AC adapter.

Connect the AC adapter to the balance.

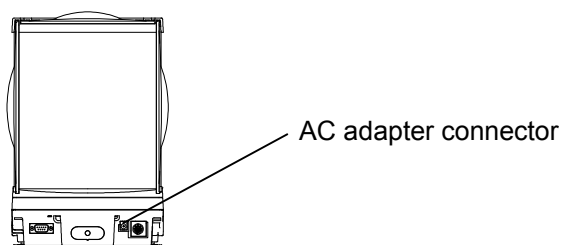

After the balance has been moved, open the windshield door to allow it to adapt to the ambient temperature for stable measurement.
In addition, allow five minutes after turning on the power for the balance to warm up.

4 Basic Operation

4.1 Power On/Off

Press the **On/Off** key to turn the power on and off.

The * sign is displayed when the balance is powered by the AC adapter and is in standby mode.



When an object is lying on the pan, the blinking [on 0] is displayed. In such cases, remove all the objects on the pan.

If a unit other than “g” (gram), “mg” (milligram) or “ct” (carat) is selected as Unit A, the unit automatically changes to “g”.

4.2 Weighing

Place a sample on the balance and close the windshield door.

A circle will be displayed after the measurement has stabilized.

Read the measurement while the circle is displayed.

The circle will not be displayed or will flicker if the balance is subject to disturbance such as vibration. Take appropriate measures to stabilize the balance.

The bar graph indicates the current load in relation to the balance’s weighing capacity. As the load approaches the weighing capacity, the bar extends towards the right.

When the weight of an object exceeds the balance’s weighing capacity, [o-Err] is displayed.

If the pan is removed and the zero-point falls below the original zero-point, [u-Err] is displayed.



Stable



Unstable

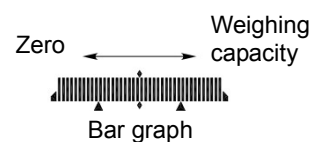

4.3 Zero Adjustment

Press the **Zero/Tare** key.

Wait until the display becomes stable (the M sign flashes), and set the display to “0”.

While the zero point is accurately maintained, the [→0←] sign is displayed.



4.4 Tare (pan)

Place the *tare* (pan) on the balance and press the **Zero/Tare** key.

When the display becomes stable, “0” is displayed.

(Continued on next page.)



This operation is called “tare” and “Net” is displayed while the weight of the pan is being set.

After the weight of the pan has been set, if a sample is placed in the container the balance will display the weight (net weight).

* When a tare range is set, the weighing capacity is reduced accordingly.

Weighing capacity = original weighing capacity – pan weight

Even after the weight of the pan has been set and the display is set to “0,” the value indicated by the bar graph includes the pan weight.

4.5 Set a Gross Weight

Press the **Function** key while the weight of the pan is being set.

The gross weight, which is the sum of the pan weight and the weight of the sample put in it, is displayed.

The B/G sign is displayed while the gross weight is being displayed.

Pressing the **Function** key will toggle the display between net weight and gross weight. (Unit B (net weight) is also displayed if it has been selected.)

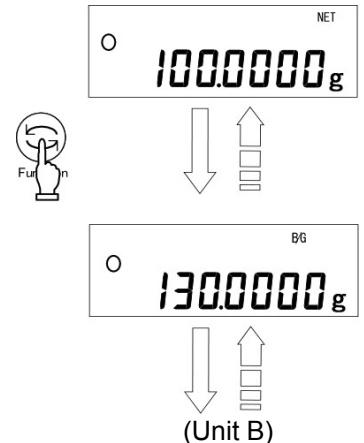

Caution:

1. A gross weight can only be displayed when the balance functions as a weighing machine.
2. When a gross weight is displayed, you cannot set a tare range. You can only adjust the zero-point.

4.6 Single-touch Response Setting

This function allows you to switch the response of the balance with a single touch of the **Set** button.

The balance will be subject to different levels of vibration depending on where it is placed. Adjusting the balance’s response according to the magnitude of vibration reduces the variation in its display and the time required for the display to stabilize.

Pressing the **Set** key once displays the current settings ([norMAL] etc.).

Pressing the **Set** key again toggles the display between [norMAL→SLoW→FASt].

After the balance settings have been completed, the display automatically returns to the weighing mode.

This function corresponds to the settings [5. rE. *] and [6. Env. *] of Function 1, and the settings in Function 1 are also changed at the same time.

(Continued on next page.)

Set key	Meanings	Description	Corresponding settings in Function 1	
			6. EnV.	5. rE.
FAST	FAST	The balance responds quickly but it is easily affected by vibration	0	1
norMAL	NORMAL	The balance's response is somewhere between fast and slow	0	3
SLoW	SLOW	The balance responds slowly but is not easily affected by vibration	1	3

(Refer to "Section 5: Function 1" on page 15 for further information on Function 1.)

In [6. EnV. *],	[0] indicates a fast response. Use this setting when the balance is subject to a low level of vibration. [1] indicates a slow response. Use this setting when the balance is subject to a high level of vibration.
In [5. rE. *],	[1] indicates the fastest response. Use this setting when the balance is subject to a low level of vibration. As the number approaches [5], the balance's response becomes slower but it is also less affected by vibration.

* To adjust the response more finely, use Function 1.

Caution

This function is unavailable when the gravimeter or addition function is enabled.

4.7 Data Output

Measured data and GLP data can be output to a personal computer, printer, or similar device via the built-in RS-232C interface. In the factory default setting, pressing the **Print** key once will output the current measured value when the measurement becomes stable.

[→] is displayed while the data is being output.

Refer to "Section 5.5: Interface" on page 20 for further information on the output settings.

4.8 Hanging Measurement

The balance is equipped with a hanging hook to suspend a hanging pan for weighing. Perform hanging measurements when weighing electromagnetic, electrostatic, or high-temperature samples that cannot be accurately weighed on the normal pan.

Remove the pan and gently tilt the balance backward.

Take care that the door does not fall off.

(Continued on next page.)

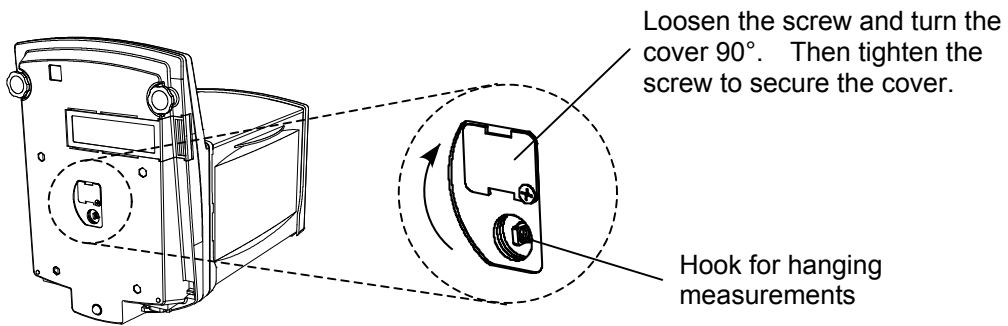

Caution

1. Tools (hanging pan etc.) suspended from the hook are regarded as a *tare* (pan). Weights equal to the weighing capacity cannot be measured.

$$\boxed{\text{Measurable weight} = \text{Weighing capacity} - \text{Total weight of tools suspended}}$$

2. Be sure to close the cover of the hanging hook when not in use to prevent dust from entering the balance.

5 Function 1

5.1 Setting and Check

1. Call Function 1.

Press and hold the **Function** key for a few seconds. When the display is changed to [Func] , release the key.

The display switches to the Function 1 setting screen and the first setting item [1. SEt 1] is displayed.

(Refer to “Section 5.2: Description of Function 1” on page 16).

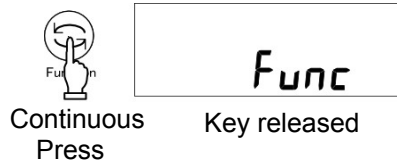

2. Select the next setting item.

Every time you press the **Function** key, you are moved one item forward.

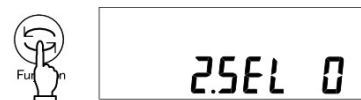

3. Change settings.

Pressing the **Zero/Tare** key toggles the right-hand value. Choose the appropriate setting.



4. Complete the setting of functions.

Press the Set key, or press the Function key several times until the balance enters measurement mode.



The setting of functions is completed, and the balance goes back into measurement mode.



The setting values of Function 1 are stored after the power is turned off. Therefore, you do not need to reenter the settings the next time the balance is used unless you wish to change them.

5.2 Description of Function 1

Contents of Function 1 (1/3)

Item	Set Value	Description	
Weighing Mode	1. SEt	1 Weighing machine (only supports weight measuring)	
		2 Parts counting (parts counting and weight measuring)	
		3 Percentage weighing (weight percent measuring and weight measuring)	
		4 Unit converting (coefficient multiplying and weight measuring)	
		5 Gravimeter (Measuring specific gravity of a solid)	→ Proceed to "Section 5.3: Specific Gravity Setting."
		6 Gravimeter (Measuring specific gravity of a liquid)	
Additional Functions	2. SEL	0 Disable additional functions	
		1 Addition function ⇒ [26. Ad.M]	
		2 Limit function	Refer to "Section 5.4, Limit/Addition Functions."
		3 Addition and limit functions	
Auto-Zero (Zero Tracking)	3. A.0	0 Disable	
		1 Enable	
Stability Judgment	4. S.d.	2 Wide (Mild)	
		3 	
		4 Narrow (Strict)	
Response Speed	5. rE.	0 Measurement by consecutive weighings	
		1 Fast	Linked to the single-touch response setting function.
		2 	
		3 	
		4 Slow	
		5	
Vibration Response Setting	6. EnV.	0 Use when the balance is subject to a low level of vibration	
		1 Use when the balance is subject to a high level of vibration	
Interface	7. I.F.	0 Stop input/output	
		2 Numeric 7-digit format	→ Refer to "Section 5.5: Interface."
		3 Extended 7-digit numeric format	
		4 Special formats	

 factory setting.

Contents of Function 1 (2/3)

Item	Set Value		Description		
Special Formats	7.	I.F.	41	Special formats 1	Displayed when [7. 1F 4] is selected.
			42	Special formats 2	
Span Adjustment Span Test (HT Series 0,3,and 4 can be selected only.)	8.	CA.	0	Disable the Cal key.	
			☆A 1	Span adjustment using built-in weights	
			2	Span test using built-in weights	
			☆B 3	Span adjustment with external weight	
			4	Span test with external weight	
Bar Graph	9.	b.G.	0	No display	
			1	Displays the bar graph	
Auto Power Off	A.	A.P.	0	Not Available in HT(R)-CE	
			1		
Auto Backlight OFF Function	b.	A.b.	0	Disable	
			1	Enable (The backlight goes off if the balance is not used for about three minutes.)	
Unit A	C1.	u.A	1	[mg]	
			2	[g]	
			4	[ct] [carat]	
			5	[oz] [ounce]	
			6	[lb] [pound]	
			7	[oz t] [troy ounce]	
			8	[dwt] [penny weight]	
			9	[GN] [grain]	
			A	[ti] [tael](Hong Kong)	
			b	[ti] , ►Upper right [tael](Singapore, Malaysia)	
			C	[ti] , ►Lower right [tael](Taiwan)	
			d	[mom] [momme]	
E	[to] [tola]				

■ factory setting. ☆A is factory setting of HTR series. ☆B is factory setting of HT series.

Contents of Function 1 (3/3)

Item	Set Value		Description
Unit B	C3. u.b	0	None
		1	The settings of [1, 2, 4-E] are the same as those of Unit A.
		E	
		E	
Auxilliary indication setting	d. Ai.	0	Disable.
		1	Enable
Advice CAL and Full-automatic Span Adjustment (HT series 0, 1 only be selected.)	E. Ad.C.	☆B 0	Disable
		1	Advice CAL
		☆A 2	Full-automatic Span Adjustment (Displayed only with the HTR series)
Compliance with ISO/GLP/GMP	F. GLP	0	Disable
		1	Enable
Output of Span Adjustment and test results	F1. out	0	Disable
		1	Enable
Data compliant with GLP	F2. od.	0	Disable
		1	Enable
Printed Language	F3. P.F.	1	English
		2	Japanese (Katakana)
Date Display	G. dAtE	1	Output in Year-Month-Day format.
		2	Output in Month-Day-Year format.
		3	Output in Day-Month-Year format.
Time Stamp Output	H. t.o.	0	Disable
		1	Outputs time together with measurement data.
Direct Start	n. d.St.	0	The balance enters standby mode when the AC adapter is plugged in.
		1	The balance is turned on when the AC adapter is plugged in.
Backlight	P. b.L.	0	Always OFF
		1	ON
		2	ON
Auxilliary scale interval output format ☆3	r. Pr.F.	1	No output when an auxilliary scale interval is being displayed
		2	Output in the normal format even when an auxilliary scale interval is being displayed.
		3	A slash "/" output in the digit preceding the auxilliary scale interval.

Displayed when [F. GLP1] is selected.

factory setting. ☆A is factory setting of HTR series. ☆B is factory setting of HT series.

5.3 Specific Gravity Setting

Displayed when [1. SEt *] is set to [5] or [6].

Item	Set Value	Description
Media	11. MEd.	0 Water
		1 Any liquid other than water
Output data	12. d.o.d.	0 Only a specific gravity value
		1 Specific gravity, weight, water temperature or specific gravity of medium (liquid), and volume
Auto output	13. A.o.	0 Disabled (Print key is used for output.)
		1 Output once after a specific gravity measurement.

5.4 Limit/Addition Functions

To be displayed when [2. SEL *] is other than [0].

Item	Set Value	Description
Condition	21. Co.	1 Always judge (even when the balance is unstable).
		2 Judge only when the balance is stable.
Range to Cover	22. Li.	0 Detect when the limit is exceeded by more than five divisions. (Do not detect when the limit is exceeded by five or fewer divisions or the limit is not reached.)
		1 Detect both when the limit is exceeded and when it is not reached.
Point Scale	23. Pi.	1 1-point scale (Only the lower limit is judged.)
		2 2-point scale (Upper and lower limits are judged.)
		3 3-point scale (scale of 1 to 4)
		4 4-point scale (scale of 1 to 5)
Judge by	24. tyP.	1 Judge by absolute values.
		2 Judge by deviation values
How to Indicate Results	25. LG.	1 Upper and lower limits or a rank is displayed.
		2 Controlled by an external input signal.
Addition operation	26. Ad.M	1 Cumulate function
		2 Net addition function

 factory setting.

5.5 Interface

Displayed when [7. I.F. *] is [2-4].

Item	Set Value	Description	
Output Control	71. o.c. ★1	0	Stop output
		1	Output continuously at all times
		2	Output continuously if stable (Stop output if unstable)
		3	Output once when the Print key is pressed (whether the balance is stable or unstable).
		4	Output once when the balance is stable. Output when a substance is lifted to cause the display to indicate a value below 0, and then another substance is put on to make the balance stable.
		5	Output once when the balance is stable. Stop output when unstable. Output once when the balance is stabilized again even if it is not reloaded (the output includes zero).
		6	Output once when the balance is stable. Output continuously when unstable. Output is stopped after a single output when the balance is stable even if it is not reloaded.
		7	Output once when the Print key is pressed if the balance is stable.
		A	Output once immediately after a specified interval.
		b	Output once immediately after a specified interval if the balance is stable.
Baud Rate	72. b.L.	1	1200 bps
		2	2400 bps
		3	4800 bps
		4	9600 bps
		5	19200 bps
Parity	73. PA.	0	None
		1	Odd
		2	Even
Data Length	74. d.L.	7	7 bits
		8	8 bits
Stop Bits	75. St.	1	1 bit
		2	2 bits
Unused High Order Digits	76. n.u.	0	Embed 0 (30H).
		1	Embed space (20H).
Response Commands	77. r.ES	1	Use A00 and Exx. (XX indicates the numerical values.)
		2	Use ACK and NAK.

 factory setting.

The data output interval is 0.1 to one second for continuous output. (The interval varies with the measurement conditions, etc.)

★1 To connect this instrument to a printer, select one numeral or letter among 0, 2, 4, 5, 7, and b.

6 Function 2

6.1 Calling and Setting

1. Call Function 2.

Press the **Function** key while holding down the **Zero/Tare** key.

When [Func2] is displayed, release the key.

The display is changed to [1. Id 0].

Press the **Function** key while holding down the **Zero/Tare** key.

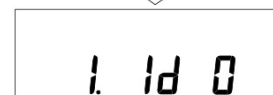

2. Change settings.

Select setting items to change with the **Function** key.

Change the setting in the right end with the **Zero/Tare** key.

3. Complete the setting of functions.

Press the **Set** key, or press the **Function** key several times until the balance enters measurement mode.

The setting of Function 2 is completed, and the balance goes back into the measurement mode.

6.2 Description of Function 2

Item	Set Value	Description	
Setup of ID No.*	1. Id	☆0	The function is disabled.
		1	Enable
Setting instrumental error of the weight in use*	2. o.M.P.	☆0	The function is disabled.
		1	Enable
Calibration of Built-In Weights ☆1	3. r.CA.	☆0	The function is disabled.
		1	Enable
Use of weight error	4. M.E.H.	☆0	Do not use.
		1	Use the weight error entered at the time of the span adjustment etc., in which an external weight was used.

A star (☆) denotes a factory setting.

The setting values for the items marked by an asterisk (*) are reset to factory defaults every time you call it.

☆1 This function is available for HTR series only when the balance is not sealed.

7 Weighing and Measurement Modes

You can select from one of five weighing modes: weighing machine, parts counting, percentage weighing, unit converting, and gravimeter. In addition, the balance is equipped with addition and limit functions as additional functions. All the weighing modes except gravimeter support the additional functions (the addition function and the limit function) depending on the display unit.

7.1 Weighing and Measurement Modes

When you select a weighing mode and additional functions, you can weigh samples in different ways as shown below. Every time you press the **Function** key, the measurement mode is switched.

Weighing Mode	Measurement Mode		Additional Functions	
	Unit	Function	Addition	Limit
Weighing machine	Unit A	Weight measuring	○	○
	Unit A B/G	Gross weight	×	×
	Unit B	Weight measuring	×	×
	Unit A Σ	Cumulative weight	Display	×
Parts counting	Pcs	Counting	○	○
	Pcs Σ	Cumulative count	Display	×
	Unit A Pcs	Average unit weight	×	×
	Unit A	Weight measuring	×	×
Percentage weighing	%	Percent measuring	○	○
	% Σ	Cumulative percent	Display	×
	Unit A	Weight measuring	×	×
Unit converting	#	Coefficient multiplying	○	○
	# Σ	Cumulative sum	Display	×
	Unit A	Weight measuring	×	×
Gravimeter (Solid/Liquid)	g (Fixed)	Measurement of specific gravity	×	×

The ○ or × signs indicate whether the additional functions are available or not.

(○: Measurement and display are available. ×: Neither support measurement nor display is available. Display: The addition value is displayed.)

You can select [g], [mom], or another unit for Unit A and Unit B.

7.2 Weighing Machine

The weighing machine function only supports [g], [kg], and other units of weight. Pressing the **Function** key displays the gross weight (refer to page 12).

Other units of weight can also be selected for Unit B.

Pressing the **Function** key toggles the display between (Net) Weight of Unit A ⇒ Gross weight ⇒ (Net) Weight of Unit A.

8 Parts Counting

When a specified number of samples are put on the balance, the balance divides the total weight of the samples by the number of samples to obtain the average sample weight. The balance stores the average sample weight based on the number of samples initially set. Additional samples, up to three times the initial number, can be added and the balance will automatically update the average sample weight. This mechanism allows accurate counting.

* Select [1. SEt 2] (Parts Counting) in Function 1.

1. Start sampling.

Make sure that the [Pcs] sign is displayed and press and hold the [Function] key for a few seconds.

(This operation may be performed with a container placed on the balance.)

When the display indicates [U. SEt], release the key.

The display then blinks [on 10].

This indicates to put 10 samples on the balance.

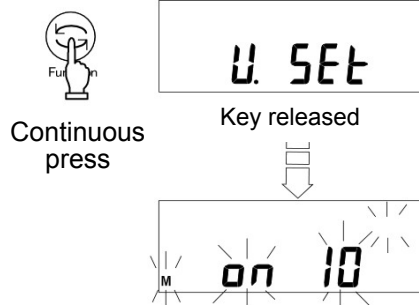

2. Change the number of samples as required.

The number of samples can be changed by pressing the [Zero/Tare] key.

If the samples vary considerably in size or are lightweight, or if more accurate counting is required, press the [Zero/Tare] key to sufficiently increase the number of samples.

If you do not need to change the number, skip this step.

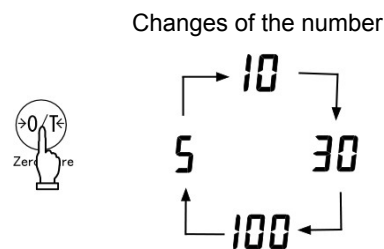

3. Put a sample on the balance.

Put as many samples as displayed in [on **] on the balance and press the [Function] key.

The display then blinks [10^{Pcs}].

4. Put additional samples on the balance.

Add up to three times the displayed number of samples and wait until the display stabilizes again.

The [+] sign is displayed and the memory is updated.

Every time the [+] sign is displayed, you may add more samples.

Repeating this operation will improve the resolution of parts counting for more accurate measurements.

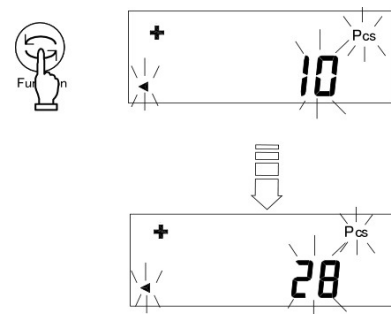

5. Finish sampling.

Press the **Function** key to finish updating the memory.

The average sample weight is saved and the balance returns to measurement mode.



6. Counting the number of samples.

After the average sample weight has been saved, the number of samples put on the balance will be displayed.

Pressing the **Function** key toggles the display between number of samples, average sample weight, and total weight.



Average sample weight

☆ **Hints** ☆

1. The [Sub] display that may be shown during a memory update of average unit weight indicates that you added more than three times as many samples as the displayed number and thus the counting accuracy is low. Do not add too many samples at a time. Gradually increase the number of samples to increase counting accuracy.
2. If a sample is lightweight the balance may display [Add] during a memory update of average sample weight. This indicates that the number of samples is too small and the counting accuracy is low. [Add] display is turned off to improve the counting accuracy.
3. When these indications are displayed, you can press the **Function** key to store the average unit weight. In this case, however, counting accuracy is low, and a counting error may be caused.
4. When [L-Err] may be displayed to indicate that the average unit weight is too small for the balance to count the samples. ([L-Err] will be displayed until a key is pressed.) For more information on the minimum unit weight supported by the parts counting function, refer to “Section 22: Specifications” on page 75.
5. Pressing the **Print** key during sampling cancels the sampling.
6. The average sample weight will be stored even after the power is turned off. If you want to count different types of samples, perform sampling again.

9 Percentage Weighing

The weight of a reference sample is saved as 100%. When a sample is placed on the balance, the balance indicates the percentage of that sample with respect to the reference sample weight. A reference sample weight can be set by weighing an actual sample or entering a value.

* Select [1. SEt 3] (Percentage Weighing) in Function 1.

9.1 Set a reference weight by weighing an actual sample

You can make the display indicate the weight percentage (%) of a sample with respect to a reference sample weight.

1. Start sampling.

Make sure that the [%] sign is displayed and press and hold the **Function** key for a few seconds.

(This operation may be performed with a container placed on the balance.)

The display then blinks [P. SEt].

The previously-saved reference sample weight blinks.

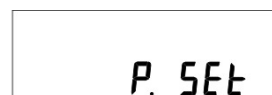

Key released



2. Put a sample on the balance.

Put the reference sample on the balance.

3. Save the reference weight.

Press the **Function** key.



4. Put a sample to weigh on the balance.

The display indicates the percentage of the sample weight with respect to the saved reference sample weight.

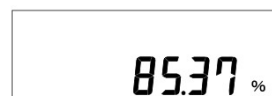

Caution:

The minimum unit is automatically selected, depending on the saved reference weight.

Min. Indication	Range of Reference Weight
L-Err	Reference weight < Lower weight limit
1%	Lower weight limit ≤ Reference weight < Lower weight limit × 10
0.1%	Lower weight limit × 10 ≤ Reference weight < Lower weight limit × 100
0.01%	Lower weight limit × 100 ≤ Reference weight

You cannot set a value below the lower weight limit as a reference weight.

* The lower weight limit depends on the model. For more information, refer to Section 22: Specifications on page 75.

9.2 Set a reference weight by entering a value

You can enter a reference weight in the balance, and then make the display indicate the weight percentage (%) of a sample with respect to the reference.

1. Displaying a reference sample weight.

Make sure that the [%] sign is displayed and press and hold the **[Function]** key for a few seconds. (This operation may be performed with a container placed on the balance.)

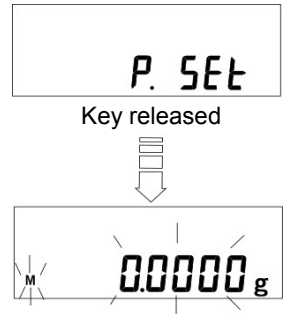

The display then blinks [P. SEt].

The previously-saved reference sample weight blinks.

2. Enter a reference weight.

Press the **[Zero/Tare]** key. The digit furthest to the right blinks.



3. Select a number.

Press the **[Zero/Tare]** key. Pressing the key changes the displayed number as shown on the right.

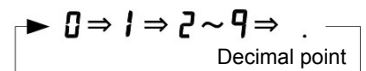

4. Select digit places to specify a reference weight.

Pressing the **[Function]** key shifts the blinking digit to the left, allowing you to set a higher-order digit. If the digit furthest to the left is blinking, pressing the key makes the digit furthest to the right blink.



5. Save the reference weight.

Press the **[Set]** key.*



(* Pressing the **[Print]** key cancels the setting of a reference sample weight.)

6. Put a sample to weigh on the balance.

Put a sample to weigh on the balance. The display indicates the weight percentage (%) of the sample with respect to the reference. Pressing the **[Function]** key toggles the display between percentage weight and total weight.

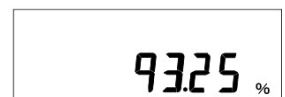

10Unit Converting

The function to convert units multiplies the weight of a sample on the balance by the saved coefficient, and displays the result.

* Select [1 Set 4] (Unit Converting) in Function 1.

1. Displaying the coefficient setting.

Make sure that the [#] sign is displayed and press and hold the [Function] key for a few seconds. (This operation may be performed with a container placed on the balance.)

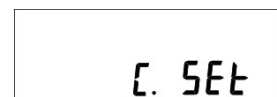

Key released

The display then blinks [C SEt].

The previously-saved reference sample weight blinks.



2. Enter a coefficient.

Press the [Zero/Tare] key. The digit furthest to the right blinks.



3. Changing numbers.

Pressing the [Zero/Tare] key changes the number as shown on the right.

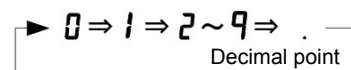

4. Select digit places to specify a coefficient.

Pressing the [Function] key shifts the blinking digit to the left, allowing you to set a higher-order digit. After a number is set, the minus sign [M] blinks. Pressing the key again makes the digit furthest to the right blink.



5. Save the coefficient.

Press the [Set] key.*



(* Pressing the [Print] key cancels the setting of a reference sample weight.)

6. Put a sample to weigh on the balance.

Put a sample to weigh on the balance. The weight of the sample is multiplied by the coefficient, and the result is displayed. For example, Displayed value (250.0000) = Coefficient (2.5) x Sample (100.0000 g)



Caution

The increment of the minimum readability is automatically set to 1, 2, or 5 depending on the entered coefficient.

11Gravimeter

A sample's specific gravity can be measured by using the balance as a gravimeter. Hang the sample from the balance using an optional hooking device. You may need to use a net, cage, string, or container to hang the sample from the balance.

* Select [1 SEt 5] (Solid Specific Gravity Measurement) in Function 1.

[11. MEd.] should be set to [0: Water] or [1: Not water] according to the medium used.

This manual describes the procedures for measuring the specific gravity of a solid by hanging it from the balance. If you are using the optional specific gravity kit or are measuring the specific gravity of a liquid, refer to the operation manual that comes with the optional specific gravity measurement kit.

11.1 Measurement procedures for specific gravity

1. Preparation for specific gravity measurements.

Put the balance on a pedestal and attach the hanging hook. Hang a cage or the like that is used for holding the sample.

As the sample weight is also measured in water, prepare a container with water whose size is enough to put the entire cage into the water.

In gravimeter mode, [d] is displayed.

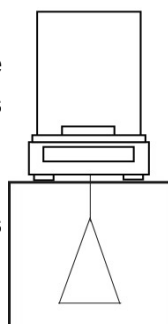

Hanging measurement



Medium (water)

2. Measure the water temperature in the container and enter the value into the balance.

Press and hold the **Zero/Tare** key to enter the temperature setting mode and then enter the water temperature (for any media other than water, enter the specific gravity value of the media). (Refer to the descriptions on page 29 for the procedures to enter the value.)

The value entered is held even after the power is turned off.



Continuous press



3. Reset the display to "0".

Press the **Zero/Tare** key with only the cage hung to reset the display to "0".

(Continued on next page.)

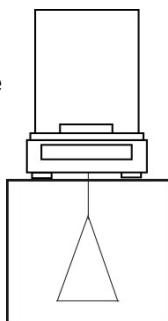

4. Measure the weight of the sample in the air.

Put a sample in a cage or on a pan, and measure the weight of the sample in air. After the weight display is stable, press the **Set** key to enter the weight. Then, [in] blinks in the display for a few seconds and the measured weight is displayed. When the weight is entered, [◀] is displayed in the lower left of the display.

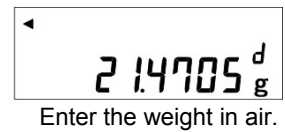
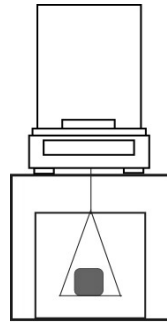

5. Submerge only the hanging cage and set to "0".

Before the measurement in water, submerge only the cage and press the **Zero/Tare** key. This is for removing any residual error due to the hanging cage.

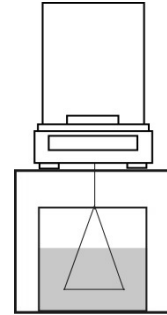

* Pressing the **Print** key interrupts the measurement.

6. Measure the weight of the sample in water.

Put the sample on the hanging cage and submerge the entire volume. Be careful that the cage does not touch the bottom of the container. After the weight display is stable, press the **Set** key to enter the weight.

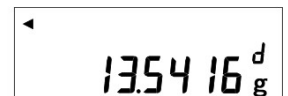
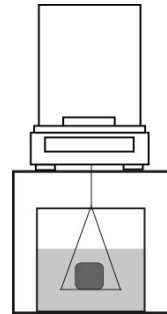

7. Displaying specific gravity

When the weight is saved, the resulting specific gravity will be displayed. Pressing the **Function** key toggles the display between the specific gravity and volume of the sample.

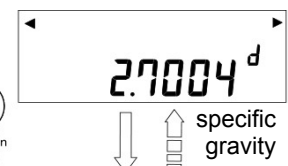

8. Return to weight display.

You press the **Set** key while a specific gravity value is displayed. The display returns to showing the sample's normal weight.

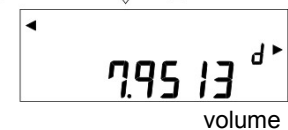

★ Hints ★

Measurements with smaller size samples may result in some variations in the measured specific gravity values. In particular, any sample whose specific gravity is larger tends to show more variation.

Use as large a sample as possible for obtaining more stable measurements.

11.2 Entering water temperature or the specific gravity of the media

This is for entering correction data for the liquid media to be used for the measurement. Enter water temperature if the media is water. Otherwise, enter the specific gravity value of the liquid. Use Function 1 [11. MEd. *] for selecting the media as follows:

1. Call the mode to enter a correction value.

Press and hold the **Zero/Tare** key to enter the temperature setting mode and then enter the water temperature (for any media other than water, enter the specific gravity value of the media).

If the media is water, [dt] is displayed on the right side of the display. Otherwise, [\blacktriangleleft d \blacktriangleright] will be indicated instead.

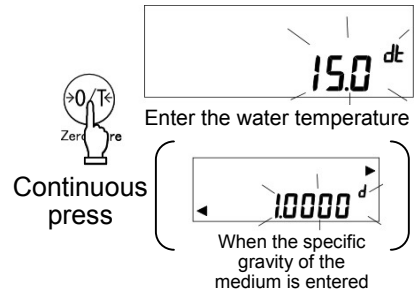

Begin entering a value.

Press the **Zero/Tare** key.

The [0] indication blinks.



2. Enter the value.

Change the value using the **Zero/Tare** key.

Pressing the key changes the value as shown on the right.

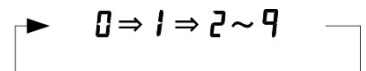

Press the **Function** key to enter a higher-order digit.

3. Save the value.

Upon completing the entry, press the **Set** key to return to the weight display mode.



Caution

The acceptable range of numeric entry is specified as follows:

Media	Input Data	Range
Water	Water temperature	0.0 to 99.9°C
Any liquid other than water	Specific gravity	0.0001 to 9.9999

If any value outside the above specified range is entered, either the minimum or the maximum value within the range will be set.

The value set is held even after the power is turned off.

Gravimeter measurement data output

(1) Output before gravimeter measurement

With the gravimeter function, the operation is with the “Pressing the **Print** key outputs the data” mode, regardless of the setting by [71. o.c. *]

(2) Output while specific gravity is displayed

[12. d.o.d.] is used for selecting the output contents.

The output method can also be selected by [13. A.o.]

(3) Output (print) format

When “specific gravity, weight, and actual water temperature or density of media” are all selected in [12. d.o.d.],.... If “specific gravity,only”is selected,only the first and second line values will be output.

In addition, if any statistical calculation is made for the printer, the values in the second line will be printed being prefixed by a serial number.

Language selection between English and Japanese for printing is made by the GLP function [F3. P.F.] of Function 1.

When water is selected

English	Japanese (Katakana)	
DENSITY SOLID 2.751	コタイビシ ユウ 2.751	(Specific gravity of solid)
SAMPLE WEIGHT 21.4705 g	ジ ユウリヨウ 21.4705 g	(Sample weight)
TEMPERATURE NOW 15.0 c	ジ ツスイオン 15.0 c	(Actual temperature)

When other than water is selected

English	Japanese (Katakana)	
DENSITY SOLID 2.414	コタイビシ ユウ 2.414	(Specific gravity of solid)
SAMPLE WEIGHT 30.0023 g	ジ ユウリヨウ 30.0023 g	(Sample weight)
DENSITY MED. LIQ 1.325	ハ イタイビシ ユウ 1.325	(Specific gravity of medium)
VOLUME/cm ³ 10.2198	タイセキ/cm ³ 10.2198	(Volume)

When the specific gravity of a liquid is selected

English	Japanese (Katakana)	
DENSITY LIQUID 1.2351	エキタイビシ ユウ 1.2351	(Specific gravity of liquid)

12 Addition Function

The addition function adds up the weights of samples put on the balance, allowing you to find the cumulative weight. Except for the gravimeter function, all other functions, i.e., weighing machine, parts counting, percentage weighing, and unit converting functions support the addition function.

12.1 Cumulate Function

With the cumulate function, a cumulative weight can be obtained while samples are reloaded. Select [2. SEL 1 or 3] and [26. Ad.M 1] in Function 1.

1. Reset the display to 0.

Press the **Zero/Tare** key.



2. Put samples on the balance, and obtain the weight.

Put samples to weigh on the balance. When the asterisk (*) sign is displayed, you can put additional samples on.



When [0] is displayed, press the **Set** key. The displayed weight is added, and the cumulative weight is displayed with a [Σ] sign for several seconds.

3. Put another sample on the balance.

Unload the balance, check that the display indicates "0", and put different samples on.

4. Read the weight.

When [0] is displayed, press the **Set** key.

After the cumulative weight is displayed with a [Σ] sign, the weight of the sample on the balance will be displayed.



5. Display the cumulative weight.

Press the **Function** key several times.

The cumulative weight is displayed with a [Σ] sign.



6. Clear the cumulative weight.

Press the **Zero/Tare** key with the cumulative weight displayed.

Pressing the **Function** key returns the display to the weight of the sample on the balance.

(Continued on next page.)



Obtain a total weight without reloading the balance

Press the **Zero/Tare** key in step 3 without unloading the balance. This will reset the display to "0".

Put additional samples on, and press the **Set** key. Then, the weight is cumulated.

Caution

1. Put additional samples on when the display indicates "0".
2. When [t-Err] is displayed when you press the **Set** key, it indicates that you put additional samples on twice, that you unloaded some samples, or that you pressed the key without adding samples.
3. You can add samples when an asterisk (*) is displayed.

12.2 Net Addition Function

The net addition function automatically performs tare range after an addition, so additions can be performed without having to replace samples. Function 1 is [2. SEL 1] and [26.Ad.M 2].

1. Reset the display to "0".
Press the **Zero/Tare** key.



2. Put samples on the balance, and obtain the weight.
Put samples to weigh on the balance. When the asterisk (*) sign is displayed, you can put additional samples on.



When [0] is displayed, press the **Set** key. The displayed weight is added, and the cumulative weight is displayed with a [Σ] sign for several seconds.

3. The balance automatically sets tare range.
The balance automatically sets the tare range.



4. Put additional samples on the balance to obtain the weight.
When [0] is displayed after adding the sample, press the **Set** key.



The displayed value is added, and the cumulative weight is displayed with a [Σ] sign for several seconds.

(Continued on next page.)

5. Display the cumulative weight.

Pressing the **Function** key several times displays the cumulative weight with a [Σ] sign.



6. Clear the cumulative weight.

Press the **Zero/Tare** key with the cumulative weight displayed.



* The cumulative weight will be cleared when “zero adjustment” or “tare range” is performed while the weight of the sample on the balance is displayed. Press the **Function** key to return to the weight display mode.

Caution

1. When [t-Err] is displayed when you press the **Set** key, it indicates that you put additional samples on twice, that you unloaded some samples, or that you pressed the key without adding samples.
2. You can add samples when an asterisk (*) is displayed.

13 Limit Function

The limit function judges a measured weight based on the limit values stored in the balance. The limit function can be set by selecting [2. SEL *] or [2] or [3] in Function 1.

The limit judgment result will be indicated by the [◀] symbol. The number of judgment points can be set from one to four.

13.1 Setting the Limit Function

Make the settings of the limit function in Function 1.

While the limit function provides various setting items, carefully read Section 5.4: Limit/Addition Functions, on page 19, before actually performing the settings.

13.2 Judgment and Saving

A limit value can be judged in the following two ways. Select an appropriate one in Function 1.

- (1) Judge by absolute values.....Specify an upper weight limit or a lower weight limit directly.
- (2) Judge by deviation values.....Specify an upper limit or a lower limit with respect to a reference weight.

A limit value can be stored in the following two ways. They can be used in combination with either of the above judgment methods.

- 1) Put actual samples on the balancePut an actual sample on the balance, and save the weight as a limit value.
- (2) Enter values.....Enter a limit value using the keys.
 - Once a limit value is entered, it is held after the balance is turned off.
 - You can set separate limit values for the weighing machine, parts counting, percentage weighing, and unit converting functions.
 - When you enter a limit value, it is treated differently between the two judgment methods. (Refer to Caution 9 on page 42.)

13.3 Display of Judgment Results

When one or two points are set, the [◀] symbol indicates one of the three judgment points in the left of the display.

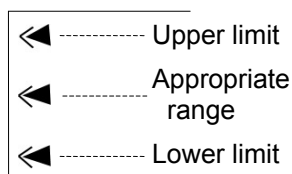

Judgment Result	When one point (lower limit) is set	When two points (lower and upper limits) are set
Above the upper limit	N/A	Upper limit < Weight
Appropriate range	Lower limit ≤ Weight	Lower limit ≤ Weight ≤ Upper limit
Below the lower limit	Weight < Lower limit	Weight < Lower limit

When 3- or 4-points are set, triangles [◀] are displayed in four or five levels according to the judgment result.

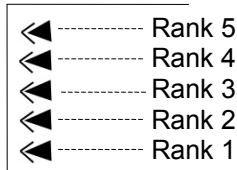

Judgment Result	(3- or 4-point setting)
Rank 5 (4-point setting)	Fourth point ≤ Weight
Rank 4	Third point ≤ Weight < Fourth point
Rank 3	Second point ≤ Weight < Third point
Rank 2	First point ≤ Weight < Second point
Rank 1	Weight < First point

The [◀] sign stays on in the range where the [◀] sign is displayed depending on the number of points set.

13.4 Judge by Absolute Values

13.4.1 Set two limit values by putting actual samples on the balance – Judge by Absolute Values –

1. Start the limit function.

Press and hold the **Set** key for a few seconds.

When the display indicates [L. SEt], release the key.

The currently saved lower limit is displayed.



2. Put the lower limit sample on the balance.

Put the lower limit sample on the pan.

3. Save the lower limit.

Press the **Function** key.

When a lower limit is saved, the value is displayed for a while.

(When one point is set, the setting is completed.)



4. Set an upper limit.

The display then indicates [H. SEt], and you can now set an upper limit.

The currently saved upper limit is displayed.

5. Put the upper limit sample on the balance.

Put the upper limit sample on the pan.

6. Save the upper limit.

Press the **Function** key.

(Continued on next page.)



When an upper limit is saved, that value is displayed for a while. Then the balance returns to measurement mode.

- * For the case of three or four point setting, repeat the above steps 2 through 3. Saved limit values are displayed as [L1 SEt] - [L3 SEt] or [L4 SEt] rather than [L. SEt] or [H. SEt]. In addition, a triangle [◀] in the left side of the display will be lit at the same time for indicating the setting level.

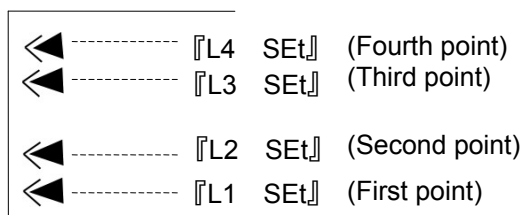

13.4.2 Set two limit values by entering values

- Switch to the setting screen of limit values.
 Press the **Set** key for a few seconds. When [L. SEt] is displayed, release the key.
 The currently saved lower limit is displayed.
- Enter a numerical value.
 Press and hold the **Zero/Tare** key.
 The digit furthest to the right blinks.
- Select a number.
 Press the **Zero/Tare** key.
 Pressing the key changes the number as shown on the right.
- Select a digit to enter a value
 Press the **Function** key.
 The blinking digit shifts to the left, allowing you to set a higher-order digit.
 After a number is set, the minus sign [M] blinks.
 Pressing the key again makes the digit furthest to the right blink.
- Save the lower limit.
 Press the **Set** key.
 The entered lower limit value is displayed. The next item will be then displayed.
 (When one point is set, the setting is completed.)

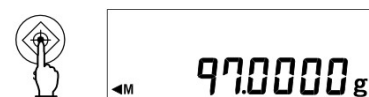
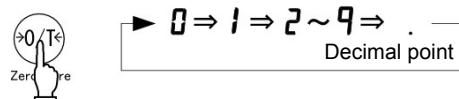

6. Setting an upper limit

[H. SEt] is automatically displayed and the currently saved upper limit blinks.

Set an upper limit in the same way as step 4 above.

After the upper limit is set, press the Set key.



* For the case of three or four point setting, repeat the above steps 2 through 5.

Saved limit values are displayed as [L1 SEt] - [L3 SEt] or [L4 SEt] rather than [L. SEt] or [H. SEt]. In addition, a triangle [◀] in the left side of the display will be lit at the same time for indicating the setting level.

To make judgments using absolute values, enter the unchanged upper and lower limits of the values that you want to judge.

Example:

When making a judgment with a lower limit of 97.0000 g and an upper limit of 105.0000 g with a 2-point setting, enter the limit values as shown below:

	Lower Limit	Upper Limit
Absolute weight	97.0000 g	105.0000 g
Input Data	97.0000 g	105.0000 g

13.5 Judge by Deviation Values

13.5.1 Set two limit values by putting actual samples on the balance – Judge by Deviation Values –

1. Start limit value setting.

Press and hold the **Set** key for a few seconds.

When [r.SET] is displayed, release the key.

The current reference value blinks.

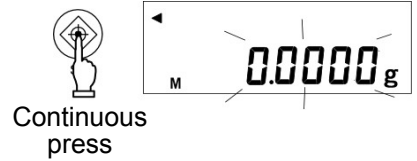

Continuous
press

2. Enter a reference weight.

Put a sample that provides a reference weight on the balance, and press the **Function** key.

When a reference weight is saved, the value is displayed. The next item will then be displayed.



3. Enter a lower limit value.

The display first indicates [L. SET], and then the current lower limit blinks. Put a sample that provides a lower limit on the balance, and press the **Function** key.



The error between the lower limit value and the reference weight is displayed. Then, you can set an upper limit.

4. Enter an upper limit value.

The display first indicates [H. SET], and then the current upper limit blinks. Put a sample that provides an upper limit on the balance, and press the **Function** key.



The error between the upper limit value and the reference weight is displayed in the same way as the setting of a lower limit. Then the balance returns to measurement mode.

(Continued on next page.)

- * For the case of three or four point setting, repeat the above steps 3 and 4.
 Saved limit values are displayed as [L1 SEt] - [L3 SEt] or [L4 SEt] rather than [L. SEt] or [H. SEt]. In addition, a triangle [◀] in the left side of the display will be lit at the same time for indicating the setting level.

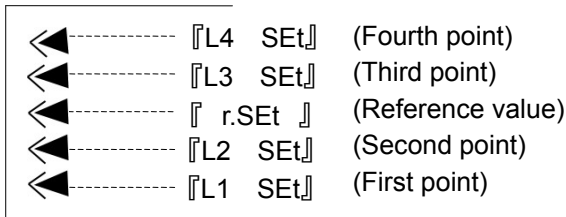

13.5.2 Set two limit values by entering values – Judge by Deviation Values –

1. Start limit value setting.

Press and hold the **Set** key for a few seconds.
 When [r.SEt] is displayed, release the key.
 The current reference value blinks.

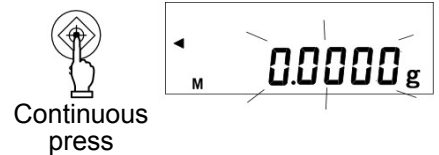

2. Switch to the value input screen.

Press the **Zero/Tare** key.
 A [0] blinks in the right end of the display.



3. Enter a reference weight.

Perform the same procedures as given in steps 3 and 4 in Section 13.4.2, “Set two limit values by entering values” on page 37 to enter a reference weight.

After the reference weight is entered, press the **Set** key to save it.



4. Enter a lower limit value.

Repeat step 3 above to set a lower limit.

When you have entered the lower limit value, press the **Set** key to save the value.

(When one point is set, the balance returns to measurement mode.)



For making judgments by deviation values, enter the errors between the reference weight and the upper and lower limits.

For example:

(Continued on next page.)

When a judgment is made with a reference weight of 100.0000 g, a lower limit of 97.0000 g and an upper limit of 105.0000 g with a 2-point setting, enter the limit values as shown below:

	Reference Weight	Lower Limit	Upper Limit
Absolute weight	100.0000 g	97.0000 g	105.0000 g
Input Data	100.0000 g	-3.0000 g	5.0000 g

5. Enter an upper limit value.

Set an upper limit in the same way as in step 3 above.

When you have entered the upper limit, press the **Set** key.

* For the case of three or four point setting, repeat the above steps 2 through 5.

Saved limit values are displayed as [L1 SET] - [L3 SET] or [L4 SET] rather than [L. SET] or [H. SET]. In addition, a triangle [◀] will be lit at the same time for indicating the setting level.

Caution

1. The initial limit values are all zero.
2. You can set separate limit values for the weighing machine, parts counting, percentage weighing, and unit converting functions. However, absolute values and deviation values are saved in the same storage area. So if you switch between absolute values and deviation values, limit values are deleted.
3. When the balance is not in measurement mode, you cannot set limit values by key operation. When a cumulative sum is being displayed, for example, you cannot set limit values.
4. Before you set limit values, adjust the zero-point or set a tare range as required. (You can adjust the zero-point or set a tare range in sampling for parts counting or weight percent measuring.)
5. You can check limit values by pressing the **Set** key.
The lower limit is displayed after the display indicates [L. SET], and the upper limit is displayed after [H. SET].
When you set three or four points, saved limit values are displayed as [L1 SET] – [L3 SET] or [L4 SET] rather than [L. SET] or [H. SET].
6. When you made a mistake in an operation, press the **Print** key.
As the operation will be cancelled, start the operation from the beginning.
(Continued on next page.)

7. If you press the **Function** key when a value is blinking in the display, the weight of the sample on the balance is set as an actual sample weight. If you press the **Zero/Tare** key here, you can now enter a limit value.
8. If the limit value entries are not lined up in the order of magnitude, five triangles [◀] will be lit regardless of the number of judgment points. Check the values and enter them again.
9. When you enter a limit value, it is treated differently between the two judgment methods. To judge by absolute values, enter limit values directly. On the other hand, to judge by deviation values, you have to specify a range with respect to a reference weight.

(Example)

To set a lower limit of 97.0000 g and an upper limit of 105.0000 g with respect to a reference weight of 100.0000 g, enter the limit values as shown below:

	Reference Weight	Lower Limit	Upper Limit
Absolute weight	100.0000 g	97.0000 g	105.0000 g
Judgment by absolute values	100.0000 g	97.0000 g	105.0000 g
Judgment by deviation values	100.0000 g	-3.0000 g	5.0000 g

13.6 Bar Graph for the 2-point Scale



You can set two points for the limit function, and display a bar graph to indicate the result in a range specified by the two points.

Except for the gravimeter function, all other functions, i.e., weighing machine, parts counting, percentage weighing, and unit converting functions can support this function.

You can put actual samples on the balance or enter values to set upper and lower limits.

You can also judge by absolute values or deviation values.

A bar graph is displayed in one of the following ways:

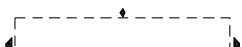

Bar graph	Weight range	Description
	Upper limit < Weight	The whole bar graph is displayed.
	Lower limit \leq Weight \leq Upper limit	A bar graph to indicate the judgment result is displayed.
	Weight < Lower limit	The bar graph is not displayed.

Caution

1. When the lower limit is the same as the upper limit, no bar graph will be displayed.
2. When a 2-point bar graph is being displayed, a normal bar graph to indicate the rate of a weight to the weighing capacity is not displayed.
3. When a 2-point bar graph is being displayed, the limit function does not work.

☆ Hints ☆

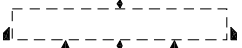
Different bar graph frames are used depending on whether the balance is in the measurement mode or in the 2-point bar graph display mode, as shown below:

Bar graph frame	Balance condition
	Measurement mode
	2-point bar graph

14 Calibration and Span Test for the Balance

Span Adjustment

An electronic balance, which is influenced by the acceleration of gravity, indicates different values depending on the location it is used. For this reason, you should calibrate your balance every time you relocate it. You should also calibrate it after a long time of no use or when it does not indicate correct values.

To calibrate a balance is called span adjustment, which is required for highly accurate measurements.

Span Test

The span test is used to check the amount of offset in the span of the balance with respect to the reference weight. Performing this function will not calibrate the balance.

* To adjust the span or perform a span test, wait at least five minutes after the power is turned on.

Select [8. CA. *] in Function 1 to set the span adjustment and conduct a span test. When the GLP compatible item is set to [F. GLP 1] and [F1.out 1], the results will be output in a GLP-compatible format. Refer to Section 18.2: "Outputting calibration results" on page 69 for further information.

14.1 Span Adjustment with Built-In Weights *This function is available only with the HTR series.

1. Press the [Ca] key.
[Aut. CAL] is displayed.
2. When [PuSH C] is displayed, press the [Ca] key again.
The built-in weight unit starts to operate, and the balance will automatically start span adjustment.
The display changes in the order of [Aut. CAL]→[CH. 0]→[CH. F.S.]→[buSy]→[End.].
When span adjustment is completed, the display returns to normal.

14.2 Span Adjustment with External Weight

1. Press the [Ca] key.
[CAL EXT] is displayed.
2. When [PuSH C] is displayed, press the [Ca] key again.
The display first indicates [CAL EXT]→[on 0], and the balance starts adjusting the zero-point.
(If a weight error is used, the corresponding weight error entered will be displayed for about two seconds.)
3. When [on F.S.] is displayed, put a weight on the pan.
The balance starts adjusting the weighing capacity.

The display indicates [buSy]→[End.] in sequence. When span adjustment is completed, the balance goes back to the normal display.

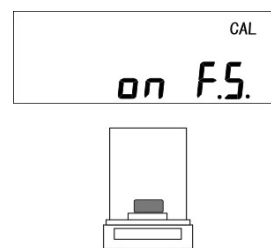

14.3 Span Test with Built-In Weights

*This function is available only with the HTR series.

1. Press the **Cal** key.
[t. Int] is displayed.
2. When [PuSH C] is displayed, press the **Cal** key again.
The built-in weight unit starts to operate, and the balance will automatically start span test. The display changes in the order of [t. Int]→[t. 0]→[t. F.S.]→[dIFF.]→[Weight error]. Pressing any key returns the display to measurement mode.

14.4 Span Test with External Weight

1. Press the **Cal** key.
[t. EXT] is displayed.
2. When [PuSH C] is displayed, press the **Cal** key again.
The display first indicates [t. EXT]→[on 0], and the balance starts testing the zero-point. (If a weight error is used, the corresponding weight error entered will be displayed for a few seconds.)
3. When [on F.S.] is displayed, put a weight on the pan.
The balance starts a weighing capacity point test.

The display first indicates [dIFF.] and then an error.
When you press a key, the balance goes back into the measurement mode.



- * After [dIFF.] is completed, the definition of a weight error is as follows:

$$\text{Weight error} = \text{True value} - \text{Current weight}$$

In other words, when a weight error is more than "0", the displayed weight is less than the actual weight.

14.5 Calibration of Built-In Weights

*This function is available only with the HTR series.

This function allows you to calibrate the built-in weight using external weights. You should perform this operation when the balance has been subjected to a strong impact.

1. Select [3. r.CA. 1] in Function 2.
Select [3. r.CA. 1] in Function 2 and press the **Function** key.
[rEF. CAL] is then displayed.
2. Calibrate the built-in weight.
While pressing the **Zero/Tare** key, press the **Function** key. Then, release both keys at the same time. [on 0] blinks and [on F.S.] is then displayed.
3. When [on F.S.] is displayed, put a weight on the pan.
[on F.S.] blinks and [on 0] is then displayed.
When [on 0] is displayed, remove the weights from the pan. The display changes in the order of [CH. 0]→[CH. F.S.]→[End.]. When the calibration has been completed, [4. M.E.H. *] is displayed. Upon completion, press the **Function** key to return to measurement mode.

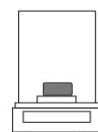

* Refer to "Section 14.6: Entry of Weight Error" on page 47 for information on [4. M.E.H. *].

☆ **Hints** ☆

1. When you press the **Print** key during span adjustment or a span test, the display indicates [StOP], and the span adjustment or test is cancelled. Then the balance goes back to the normal display.
 2. To perform span adjustment or a span test with an external weight, use a weight for calibration that weighs 50% of the weighing capacity or heavier. To calibrate more accurately, use a weight that is close to the weighing capacity.
* Please contact your local dealer, if you wish inquire about or place an order for calibration weights.
 3. When an error is found in span adjustment or in a span test, the following messages are displayed:
 - (1) [1-Err]: You used a weight weighing less than 50% of the weighing capacity for span adjustment.
 - (2) [2-Err]: An error over 1.0% was detected in span adjustment with an external weight, or the balance failed.
 - (3) [3-Err]: An object was placed on the pan during span adjustment.
 - (4) [4-Err]: The weight error exceeded 1.0% during span adjustment, or the balance failed.
 - (5) [A-Err]: The internal drive unit malfunctioned during span adjustment. (Pressing any key while an error message is displayed returns the display to measurement mode.)
- * When one of these messages is displayed, calibration will not be performed. Check that you are using a proper weight, and start span adjustment or a span test again. If span adjustment with a proper weight results in the same error message, contact our local dealer.
4. With the GLP-compatible output selected, [buSy ] is displayed if span adjustment is performed, and "Weight error" is displayed if a span test is performed while the data is being output. While the data is being output, the balance may seem to not be moving but this does not mean it has malfunctioned. Wait until the output is completed. (Refer to Section 18: "Use Printers" on page 69.)

14.6 Entry of Weight Error

By entering the weight error of an external reference weight to be used in span adjustment or span test, a more accurate calibration can be performed. Enter the weight error obtained from the following equation: (Weight errors are entered in the unit of mg.)

$$\text{Weight Error} = \text{Actual Weight} - \text{Nominal Value}$$

Example: For a 100 g weight, a weight error may be $= 100.00012 - 100$
 $= 0.00012 = +0.12 \text{ mg}$

1. Select [2. o.M.P. 1] in Function 2.

2. Display the weight error.

(When you only want to check the current weight error, press the **Function** key. [3. r.CA. 0] for the next item.)



3. Start entering the weight error.

Press the **Zero/Tare** key. The leftmost digit blinks first.



4. Enter a numerical values.

Pressing the **Zero/Tare** key allows you to change the blinking value.

Pressing the **Function** key makes a higher-order digit blink.

After a number is set, the minus sign [M] blinks. Pressing the key again makes the digit furthest to the right blink.

Pressing the **Print** key returns the display to Step 2.

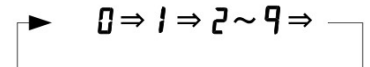

5. Save the weight error

Press the **Set** key.

([3. r.CA. 0] shown on the next page is displayed [refer to page 45].)

Press the **Set** key to return the display to measurement mode.



Using a saved weight error

For using the weight error entered, set to Function 2 to [4. M.E.H. 1].

☆ Hints ☆

If more than one weight is used in combination, enter the total error of the weights to be used. The range of the weight error should be within ± 100.00 mg. If any value outside the range is entered, it will result in the display of [r-Err]. When [r-Err] is displayed, press any key to return the display to Step 2.

14.7 Advice CAL and Full-automatic Span Adjustment

When Advice CAL determines that a certain amount of time (4 hours) has elapsed or that the temperature has changed (5°C or more) since the previous span adjustment, the “CAL” sign flashes, indicating that the balance needs to be calibrated. Perform a span adjustment immediately when the “CAL” sign begins flashing.

To use this function, set Function 1 to [E. Ad.C. 1].

“Full-automatic span adjustment” is available only with the HTR series.

This function automatically performs a span adjustment with built-in weights when “Advice CAL” determines that the balance needs to be calibrated, causing the “CAL” sign to flash.

The span adjustment using built-in weights will be performed about 10 minutes after the [CAL] sign begins flashing, once the balance has stabilized with no load.

“Full-automatic span adjustment” can be performed only when [8. CA. 1] (span adjustment with built-in weights) is enabled.

14.8 Auto Repeatability Measurement (ARM) *This function is available only with the HTR series.

This is a function to calculate a standard deviation by loading and unloading the built-in weight and repeating span adjustment 10 times. Stable measurement can be performed by adjusting the response through the single-touch response setting function.

Press and hold the **[Cal]** key for a few seconds. When [ArM] is displayed, release the key.



Continuous
press



After a while, the display switches to [Cnt. 1] and the measurement starts. As the repeatability measurement proceeds, the number of measurements displayed in [Cnt. *] increases accordingly until it reaches [10].

When the measurement is completed, the standard deviation, for example, [0.000073g], is displayed.

Pressing any key returns the display to measurement mode.

To cancel the measurement, press the **[Print]** key.

Refer to page 12 for setting the single-touch response.

15 Date and Time Setup

15.1 Time Setup

Set the time in Hour-Minute-Second format on a 24-hour basis.

1. Display the time.

Press the **Function** key for a few seconds. When the display switches from [Func] to [d-SEt], release the key.



Continuous
press

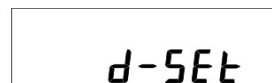

Key released



Press the **Function** key one time.

[t IME] is displayed, and then the clock time is displayed.

2. Set the time.

Press the **Set** key. You can change a blinking digit.

Use the **Zero/Tare** key to change the blinking digit.

Use the **Function** key to blink the next digit to the right. If you press the **Function** key when the rightmost digit is blinking, the leftmost digit blinks.

When you press the **Print** key before saving a time, the original time is displayed.



3. Save the time.

Press the **Set** key.

The date is displayed. Press the **Function** key to exit the setting screen.

15.2 Date Setup

The last two digits of the year are displayed. You can change the date format in Function 1.

1. Display the date.

Performing step 1 of Section 15.1 to display [d-SEt].

(If this operation is performed after Section 15.1, skip this step 2.)



Continuous
press

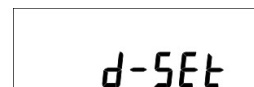

Key released

Press the **Function** key to display the clock time and press the **Function** key again.

The display automatically indicates a date after indicating [dAtE].

2. Set a date.

Press the **Set** key. You can change a blinking digit.

Use the **Zero/Tare** key to change the blinking digit.

Use the **Function** key to blink the next digit to the right.

If you press the **Function** key when the rightmost digit is blinking, the leftmost digit blinks.

When you press the **Print** key before saving a date, the original date is displayed.

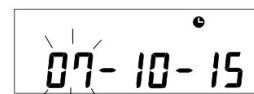

3. Save the date.

Press the **Set** key.

16 Various Functions

16.1 Auto Backlight OFF

This function turns off the backlight if the balance is left untouched in measurement mode for about three minutes.

To use the Auto Backlight OFF function, enable it in Function 1 [b. A.b. 1].

When the backlight goes off in Auto Backlight OFF mode, touching the balance or pressing any key turns it back on again.

Caution

Under the following conditions, the Auto Backlight OFF function will not work even if [b. A.b. 1] is enabled.

1. During the setting of Function 1, Function 2, the time or date, or the interval function.
2. An object is put on the pan, and the display is not stable.

16.2 Set Unit

This is a function to allow you to select two units (unit A and unit B) and switch between the units.

Which unit to display can be set in Function 1. You can also set the same unit for unit A and unit B. Pressing the **Function** key switches the unit between unit A and unit B.

Caution

To use unit B, select the weighing machine function in Function 1 [1. SET 1]. Unit A can be used in all the measurement types of the balance.

16.3 Date Display

This is a function to set the date format to be displayed in the balance or output to a printer.

Set date format in Function 1 [G. dAtE *]:

16.4 Time Stamp Output

This is a function to output measurement data with the current time. You should set the time before this function is used.

To use this function, enable it in Function 1 [H. t.o. 1].

16.5 Direct Start

This is a function to turn on the balance automatically when it is connected to the AC power. You can use this function when the balance is used in conjunction with other devices. To use this function, enable it in Function 1 [n. d.St. 1].

16.6 Interval Output Function

This function outputs data at regular intervals. Intervals can be set in hours, minutes, or seconds. To use the interval output function, select [71. o.c. A] or [71. o.c. b] in Function 1.

1. Call the interval function.

Press and hold the **[Set]** key for a few seconds. When [Int.VAL] is displayed, release the key for a few seconds.

The display indicates an interval with the leftmost digit blinking.



2. Set an interval.

Press the **[Zero/Tare]** key to change the value of the blinking digit.

[Function] key to blink the next digit to the right.

If you press the **[Function]** key while the rightmost digit is blinking, the leftmost digit blinks.

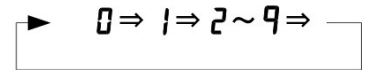

(Pressing the **[Print]** key cancels the entered value and returns the display to measurement mode.)



3. Save the settings, and go back to measurement mode.

Press the **[Set]** key.

To start interval output

Press the **[Print]** key.

The display indicates [StArt], and starts interval output.

A [●] blinks during interval output. A [↔] lights up when data is output.

To stop interval output

Press the **[Print]** key.

The display indicates [End.], and the balance goes back to measurement mode.

Caution

1. The output stops while Function 1 or 2 are displayed.
2. [6-Err] is displayed if the interval is set to "0". Set another interval. (Press any key to delete the error message.)

* The current time can be output with the measurement data. To output the time with the measurement data, refer to 16.7: "Time Stamp Output" on page 52.

16.7 Input of ID No.

An ID number is used when data is printed in compliance with ISO/GLP/GMP. Set an ID number when you print data.

When an ID number is displayed, two triangles, [◀] and [▲] are displayed in the upper left part of the display.

You can use up to six digits in an ID number. You can use [] (blank) → [0-9] → [A-F] → [-], which are displayed in this order.

1. Select [1. Id 1] in Function 2.

Press the **Function** key to display the ID number.



2. Display an ID number.

The current ID number is displayed.*¹

3. Start to enter an ID number.

Press the **Zero/Tare** key.

The leftmost digit blinks first.

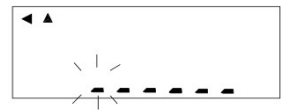

4. Enter an ID number.

Press the **Zero/Tare** key to change the blinking value.

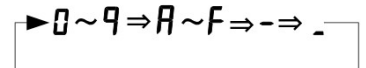

Function key to blink the next digit to the right. If you press the **Function** key when the rightmost digit is blinking, the leftmost digit blinks.



(Pressing the **Print** key returns the display to Step 2.)

5. Save the ID number.

Press the **Set** key.

(The display switches to the next item [2. o.M.P. 0].)

Pressing the **Set** key again returns the display to measurement mode.



* If you only want to check the ID number, hold the **Function** key.

The display switches to the next item [2. o.M.P. 0].

17 Input/Output Functions

17.1 RS232C Output

17.1.1 Connector pin numbers and functions

Pin No.	Signal Name	Input/Output	Function & Remarks
1	-	-	-
2	RXD	Input	Receiving data
3	TXD	Output	Transmitting data
4	DTR	Output	HIGH (When the balance is powered ON)
5	GND	-	Signal ground
6	-	-	-
7	-	-	-
8	-	-	-
9	-	-	-

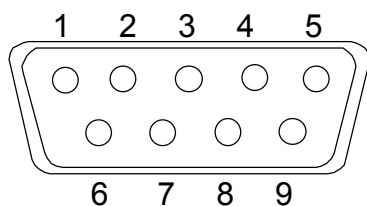

D-SUB9P Male Connector: Rear Panel

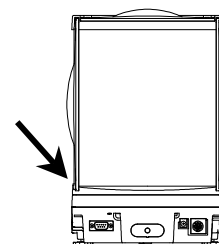

Caution

Be sure to disconnect the AC adapter from the power outlet before plugging or unplugging the connector.

17.1.2 Connecting between the balance and a PC

■■■ Sample connection with an IBM-PC/AT compatible machine ■■■

IBM-PC/AT compatible machine

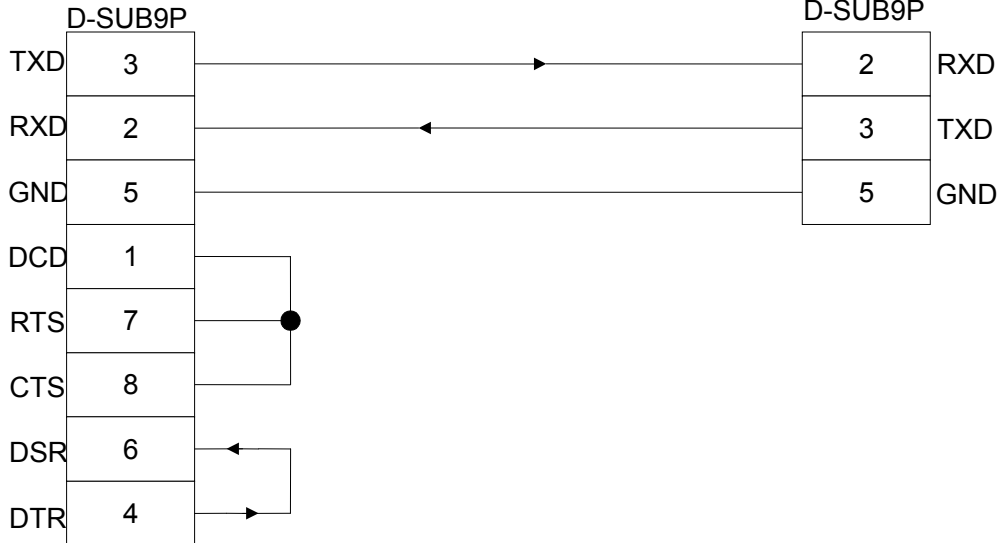

■■■ Sample wire connection with PC9801 ■■■

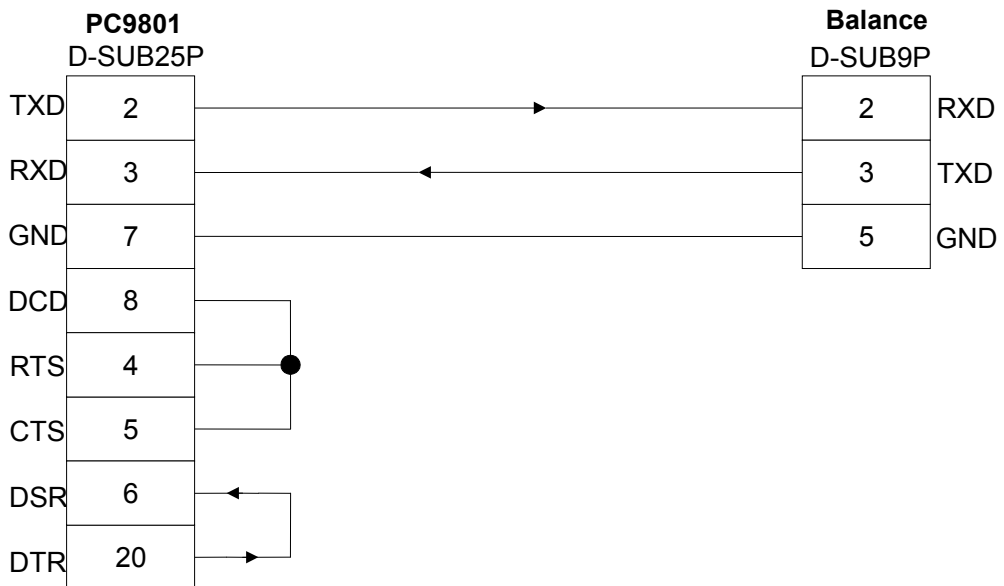

17.1.3 Interface specifications

- | | |
|-------------------------|--|
| (1) Transmission system | Serial transmission, Start-stop synchronization |
| (2) Transmission rate | 1200/2400/4800/9600/19200 bps |
| (3) Transmission codes | ASCII codes (8/7 bits) |
| (4) Signal level | Compliant with EIA RS-232C.
HIGH level (data logic 0) +5 to +15 V
Low level (data logic 1) -5 to -15 V |
| (5) Bit configuration | Start bit one bit
Data bits 8/7 bits
("7 bit" can be specified only for the extended 7-digit numeric format.)
Parity bit 0/1 bit
Stop bits 2/1 bit
("one bit" can be specified only for the extended 7-digit numeric format.) |
| (6) Parity bit | None/Odd/Even |

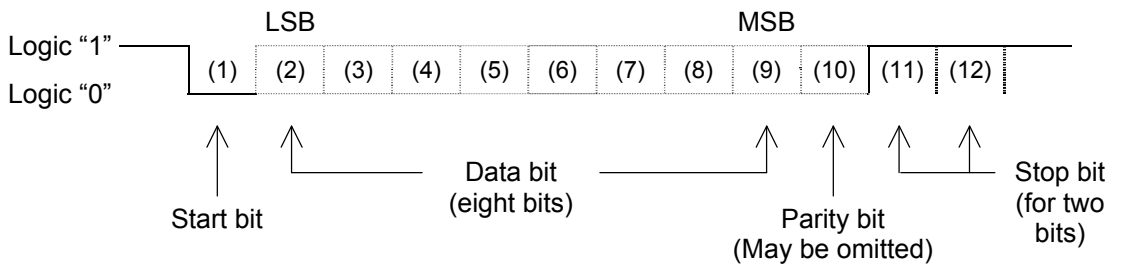

17.2 Output to Peripherals

Our standard peripheral units can be connected to the balance. *1

These peripheral units include: CSP-160

17.2.1 Connector pin numbers and functions

Pin No.	Signal Name	Input/Output	Function & Remarks
1	EXT.TARE	Input	Tare setting from an external device *2
2	-	-	-
3	-	-	-
4	TXD	Output	Transmitting data
5	GND	-	Signal ground
6	-	-	-
7	-	-	-
8	-	-	-

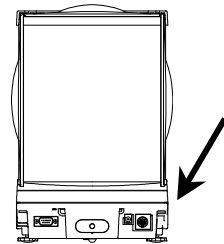
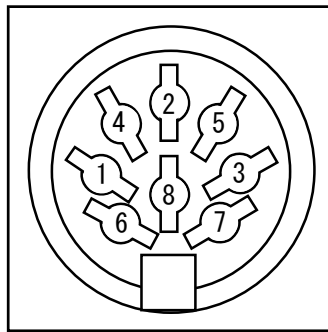

DIN8P output to peripheral devices

- *1 To connect a peripheral unit to the balance, use the connection cable supplied with the unit.
- *2 You can set a tare range or adjust the zero-point from an external device by connecting a contact or a transistor switch between pin 1 and pin 5. In this case, allow at least 400 ms for connection (ON) time (Maximum voltage when the balance is turned OFF: 15 V, sink current when it is turned ON: 20 mA.)

Caution

Be sure to disconnect the AC adapter from the power outlet before plugging or unplugging the connector.

17.3 Type of Communication Texts

This interface function uses the following three types of communication texts:

- (1) Output data Data, such as weight values, that is output from the balance to an external unit
- (2) Input commands Commands to control the balance from an external unit
- (3) Response Response that is output from the balance to an input command

Caution

1. All of these communication texts can be used for RS232C output.
2. Only output data (1) can be used for a peripheral output unit.

17.4 Output Data

You can select one from the following three formats in Function 1:

17.4.1 Data format

- (1) 7-digit numeric format

Consists of 15 characters including terminators (CR=0DH, LF=0AH). A parity bit can be appended.

1	2	3	4	5	6	7	8	9	10	11	12	13	14	15
P1	D1	D2	D3	D4	D5	D6	D7	D8	U1	U2	S1	S2	CR	LF

- (2) Extended 7-digit numeric format

Consists of 15 characters including terminators (CR, LF). A parity bit can be appended. This is an extended version of the 7-digit numeric format. The extended version is different from the 7-digit numeric format in that:

- the data length can be seven bits rather than eight bits, and
- the stop bit length can be one bit rather than two bits.

The extended version is the same as the normal 7-digit format in other bits. However, if you select Japanese (katakana) for [E3. P.F.] (printed language) in Function 1, the data length is automatically set to eight bits.

- (3) Format with 7-digit value with auxiliary scale interval that is compatible with type approval

This format is composed of 16 characters, including the terminators (CR=0DH, LF=0AH).

A parity bit can be added. A slash “/” is inserted before the auxiliary scale interval.

While the format with 7-digit value is selected, the auxiliary scale is output in this format.

1	2	3	4	5	6	7	8	9	10	11	12	13	14	15	16
P1	D1	D2	D3	D4	D5	D6	D7	D8	D9	U1	U2	S1	S2	CR	LF

- (4) Extended format with 7-digit value with auxiliary scale interval that is compatible with type approval

This format is composed of 16 characters, including the terminators (CR=0DH, LF=0AH). A parity bit can be added. A slash “/” is inserted before the auxiliary scale interval.

While the extended format with 7-digit value is selected, the auxiliary scale is output in this format. The settings for data length and stop bit are the same as those for the extended format with 7-digit value.

1	2	3	4	5	6	7	8	9	10	11	12	13	14	15	16
P1	D1	D2	D3	D4	D5	D6	D7	D8	D9	U1	U2	S1	S2		

17.4.2 Polarity (P1: 1 character)

P1	ASCII code	Description
+	2BH	When data is zero or positive.
-	2DH	When data is negative.

17.4.3 Numeric data

6-digit numeric format: (D1-D7: seven characters)

7-digit numeric format: (D1-D8: eight characters)

D1 to D7(D8)	ASCII code	Description
0 – 9	30H to 39H	Digits 0 – 9
•	2EH	* Decimal point (floating) * Omitted when numeric data does not contain decimal places. In this case, space is output to the least significant digit.
SP (Space)	20H	* A space heading a numeric value * When numeric data does not contain decimal places, space rather than a decimal point is output to the least significant digit.*1

*1 A numeric value is headed by 0 (30H) by factory default setting. You can change the function setting so that it is headed by space (20H) rather than “0”.

17.4.4 Unit (U1, U2: 2 characters)

U1	U2	ASCII code		Unit	Balance indicators
M	G	4DH	47H	milligram	mg
(SP)	G	20H	47H	gram	g
C	T	43H	54H	carat	ct
O	Z	4FH	5AH	ounce	oz
L	B	4CH	42H	pound	lb
O	T	4FH	54H	troy ounce	oz t
D	W	44H	57H	pennyweight	dwt
G	R	4BH	52H	Grain	GN
T	L	54H	4CH	tael (Hong Kong)	ti
T	L	54H	4CH	tael (Singapore, Malaysia)	ti ►Top right
T	L	54H	4CH	tael (Taiwan)	ti ►Bottom right
M	O	4DH	4FH	momme	mom
t	o	74H	6FH	tola	to
P	C	50H	43H	parts counting	Pcs
(SP)	%	20H	25H	percentage weighing	%
(SP)	#	20H	23H	Coefficient computation result	#

17.4.5 Judgment result when the limit function is enabled (S1: 1 character)

S1	ASCII Code	Description	
L	4CH	Too little (LO)	1- or 2-point scale
G	47H	Proper (OK)	
H	48H	Too much (HI)	
1	31H	Rank 1	3- or 4-point scale
2	32H	Rank 2	
3	33H	Rank 3	
4	34H	Rank 4	
5	35H	Rank 5	
T	54H	Cumulative value	Data type
U	55H	Unit weight	
(SP)	20H	No judgment result or no data type specified	
d	64H	Gross	

17.4.6 Status (S2:1 character)

S2	ASCII Code	Description
S	53H	Data stable *
U	55H	Data unstable *
E	45H	Data error (Indicates that data other than S2 is invalid.) ([o-Err], [u-Err])
(SP)	20H	No status specified

* Data that is independent of whether the weighing condition is stable or not, such as cumulative values and unit weights, is independent of whether S2 is S or U when it is output.

17.4.7 Output data other than measurement data

The following data is accompanied by our proprietary printer control commands prior to and after the data when output.

(1) Interval output

When each interval output is started or stopped, a header and a footer are output.

Header

'.' is output for 15 characters and terminators (CR=0DH, LF=0AH).

1	2	3	4	5	6	7	8	9	10	11	12	13	14	15
-	-	-	-	-	-	-	-	-	-	-	-	-	-	-

Footer

Two linefeeds are inserted.

Time output

When the time stamp function is enabled, the time is output one line above the output data.

1	2	3	4	5	6	7	8	9	10
h	h	:	m	m	:	s	s	CR	LF

* hh: hour (00-23), mm: minute (00-59), ss: second (00-59)

17.5 Input Commands

The following eight input commands are supported:

- | | |
|----------------------------------|----------------------------------|
| (1) Tare range command | (5) Request time output command |
| (2) Set output control command | (6) Set interval command |
| (3) Set measurement mode command | (7) Span adjustment/test command |
| (4) Request date output command | (8) Setting limit values |

17.5.1 Procedure for transmission

- (1) An input command is sent from an external device.

The full-duplex transmission system allows you to send an input command at any time independently of the data transmit timing of the balance.

- (2) Upon successful completion of an input command, the balance will send out either a normal completion response or the data requested by the command. If the operation has not resulted in normal completion, or if the received input command is invalid (in error), the balance will transmit an error response.

When the balance is in normal display mode, it usually sends a response to an input command within one second after it is received.

However, if the balance receives a tare range command when the Set Tare function is set so that the display is reset to "0" when the balance is stabilized after the Zero/Tare key is pressed, or if it receives an input command that takes a long time, it sends a response after the command is completely processed.

If the balance receives an input command when you are setting a function, when it is under span adjustment, or it is busy for other reasons, it sends a response after that operation is completed.

- 1) Commands to which a response is sent back after a specified operation is executed:
 - Tare range command, span adjustment/test command
- 2) Commands to which a response is sent back immediately or in one second after they are received:
 - Commands other than those specified in (1) above
- 3) Once you have sent an input command from an external device, do not send another input command to the balance until the external device receives a response to the command from the balance.

17.5.2 Response

You can select the response format of either the [A00/Exx format] or the [ACK/NAK format] in Function 1.

(1) [A00/Exx format]

Consists of five characters including terminators (CR, LF).

1	2	3	4	5
A1	A2	A3	CR	LF

Response types

A1	A2	A3	ASCII code			Meaning
A	0	0	41H	30H	30H	Successful completion
E	0	1	45H	30H	31H	* Command error (when an errant command is received)
E	0-9	0-9	45H	30H 39H	30H 39H	(Errors other than E01) * Numeric format error * Processing interrupted * Processing terminated abnormally * Other errors

(2) ACK/NAK format

Consists of one character (Does not contain a terminator).

1
A1

Response types

A1	ASCII code	Meaning
ACK	06H	Successful completion
NAK	15H	* Command error (when an errant command is received) * Numeric format error * Processing interrupted * Processing terminated abnormally * Other errors

* The following descriptions and tables assume that the [A00/Exx format] is selected as the response format.

Think of A00 as ACK, and E00 as NAK.

17.5.3 Command format

(1) Tare range (zero-setting) command

C1	C2	ASCII code		Description	Value	Response
T	(SP)	54H	20H	<ul style="list-style-type: none"> Set Tare Range Adjust the zero-point 	None	A00: Successful completion E01: Command error E04: A tare range cannot be set or the zero-point cannot be adjusted (because of a range violation or a weight error).

(2) Set output control command

C1	C2	ASCII code		Description	Response
O	0	4FH	30H	Stop output	A00: Successful completion E01: Command error E02: Interval time error (only with OA or OB)
O	1	4FH	31H	Output continuously at all times	
O	2	4FH	32H	Output continuously if stable (Stop output if unstable)	
O	3	4FH	33H	Output once when the Print key is pressed (whether the balance is stable or unstable).	
O	4	4FH	34H	Output once when the balance is stable. Output when a substance is lifted to cause the display to indicate a value below zero, and then another substance is put on to make the balance stable.	
O	5	4FH	35H	Output once when the balance is stable. Stop output when unstable. Output once when the balance is stabilized again (the output includes zero) even if it is not reloaded.	
O	6	4FH	36H	Output once when the balance is stable. Output continuously when unstable. Output is stopped after a single output when the balance is stable even if it is not reloaded.	
O	7	4FH	37H	Output once when the Print key is pressed if the balance is stable.	
O	8	4FH	38H	Output once immediately	
O	9	4FH	39H	Output once after stabilized	
O	A	4FH	41H	Interval function (Output once each time the output time elapses.)	
O	B	4FH	42H	Interval function (Output once if stable each time the output time elapses.)	

* Commands O0 to O7 control output in the same way as the settings in Function 1.

* Commands O8 and O9 are used to request data from the balance.

* Once executed, O0 to O7, OA, or OB commands is held until the next command is input. However, output control is reset to the function setting when the balance is turned on again.

* When command OA or OB is input, the balance initiates the interval function, and when the same command is input again, it terminates the function.

* When either an O8 or O9 command is executed, it returns to the state of "O0".

17.5.4 Set measurement mode command

Command Main Body				Description	Value	Response
first character	second character	ASCII code				
M	1	4DH	31H	Set to Mode 1	None	A00: Successful completion E01: Command error E02: (error)
M	2	4DH	32H	Set to Mode 2		
M	3	4DH	33H	Set to Mode 3		
M	4	4DH	34H	Set to Mode 4		

* The measurement mode to be activated by the above mode settings 1 to 4 depends on the weighing mode currently in use.

Mode setting	Weighing machine	Parts counting	Percentage weighing	Unit converting	Gravimeter
Mode 1	Weight measuring	Weight measuring	Weight measuring	Weight measuring	(Error)
Mode 2	Gross weight	Parts counting	Percent measuring	Coefficient multiplying	(Error)
Mode 3	Cumulative weight ^{*1}	Cumulative count ^{*1}	Cumulative percent ^{*1}	Cumulative sum ^{*1}	(Error)
Mode 4	Display in unit B ^{*2}	Average unit weight	(Error)	(Error)	(Error)

*1 Mode 3 (M3) can be specified only when the addition function is to be used. If the addition function is not enabled, it results in an error.

*2 If a unit is not specified for unit B, the balance is set for the weight measuring mode. When you specify a mode that is not supported by the current Weighing Mode, an error is returned from the balance.

17.5.5 Request date or time output command

Command Main Body				Description	Value	Response
first character	second character	ASCII code				
D	D	44H	44H	Date output request	None	A00: Successful completion E01: Command error
D	T	44H	54H	Time output request		

(1) Date format

DATE:yyyy.mm.dd(CR)(LF)

English

ヒツ ㇿ:yyyy.mm.dd(CR)(LF)

Japanese (Katakana)

(2) Time data

TIME:(SP)(SP)(SP)(SP)(SP)hh:mm(CR)(LF)

English

ｼ ｺㇿ:(SP)(SP)(SP)(SP)(SP)hh:mm(CR)(LF)

Japanese (Katakana)

The above data is accompanied by a control command of our printer when output.

*1 You can select whether you want to output data in English or in Japanese (katakana) in the Printed Language [F3. P.F.] Function setting.

*2 Date format depends on the setting of Date Display in Function 1 [G. dAtE].

17.5.6 Setting intervals

Command Main Body				Description	Value	Response
first character	second character	ASCII code				
I	A	49H	41H	Interval time setup	Interval time	A00: Successful completion E01: Command error E02: Interval time error

Caution

Insert a comma between the entries for hours, minutes, and seconds; e.g., IA, hh, mm, ss.

17.5.7 Span adjustment/test command

Command Main Body				Description	Value	Response
first character	second character	ASCII code				
C	0	43H	30H	Disables Cal key and command inputs. ^{*1*2}	None	A00: Successful completion E01: Command error E02: Operation is disabled. E03: Cancelled by operation E04: Abnormal completion
C	1	43H	31H	Span adjustment with built-in weights ^{*3}		
C	2	43H	32H	Span test with built-in weights ^{*3}		
C	3	43H	33H	Span adjustment with external weight		
C	4	43H	34H	Span test with external weight		

This command takes time because the balance sends back a response after an appropriate operation is completed.

If the **Cal** key is disabled in Span Adjustment/Span Test of Function 1 [8. CA.], a span adjustment and test command does not work.

*1 If the **Cal** key is disabled, however, the setting is reset to the function setting when the balance is turned on again or [8. CA.] is changed directly.

*2 Span adjustment/test command will also be invalid.

*3 "C1" and "C2" commands are available only with the HTR series.

17.5.8 Setting limit values

Command Main Body				Description	Value	Response
first character	second character	ASCII code				
L	A	4CH	41H	First setting point/lower limit	Limit values	A00: Successful completion E01:Command error E02:Set value error
L	B	4CH	42H	Second setting point/upper limit		
L	C	4CH	43H	Reference value		
L	D	4CH	44H	Third setting point		
L	E	4CH	45H	Forth setting point		

Caution

1. Insert a comma between command entries and limit values; e.g., LA, nnn.
2. Enter numerical values only. You do not need to enter units.
3. In weighing machine mode, the unit set in Unit A is applied to the entered value. For example, when "LA, 20.00" is transmitted, it is recognized as 20.00 g if gram is selected in Unit A, and 20.00 ct if carat is selected in Unit A.
4. The units used for parts counting, percentage weighing, and unit converting are PCS, %, and # respectively.

17.5.9 Sample input commands

T(SP)(CR)(LF)	Set tare range or adjust to zero-point.
O1(CR)(LF)	Set the balance to continuous output.
O8(CR)(LF)	Output data (once immediately).
IA,01,30,00(CR)(LF)	Set an interval of 01 hrs: 30 min: 00 sec.
OA(CR)(LF)	Start the interval function.
DD(CR)(LF)	Output the date.
DT(CR)(LF)	Output the time.
LA,80.5(CR)(LF)	Set the first setting point to 80.5. (The unit varies depending on the weighing mode.)

17.6 Special Format Output

17.6.1 Special format 1

This output format is applied when [7. I.F. 41] is selected in Function 1.

1	2	3	4	5	6	7	8	9	10	11	12	13	14	15	16
P1	SP	D1	D2	D3	D4	D5	D6	D7	D8	SP	U1	U2	U3	CR	LF
Set value error	Space	Measurement data (including decimal point)								Space	Unit			Terminator	

- P1 (One character): Set value error Polarity plus/zero: [+] (2BH), Minus: [-] (2DH)
- SP (One character): Space [] (20H)
- D1-D8 (Eight character): Measurement data, numerical value [0 to 9] (30H–39H), and decimal point (2EH)

* Numerical values are right-aligned.

A space (20H) is used when there is no numerical value.

- SP (One character): Space [] (20H)
- U1-U3 (Three character): Unit

(**H) : ASCII code △ : Space

Unit	Output	ASCII code
mg	mg△	(6DH) (67H) (20H)
g	g△△	(67H) (20H) (20H)
carat	ct△	(63H) (74H) (20H)
ounce	oz△	(6FH) (7AH) (20H)
pound	lb△	(6CH) (62H) (20H)
troy ounce	ozt	(6FH) (7AH) (74H)
penny weight	dwt	(64H) (77H) (74H)
grain	GN△	(47H) (4EH) (20H)
tael(Hong Kong)	tlh	(74H) (6CH) (68H)
tael(SG)	tls	(74H) (6CH) (73H)
tael(Taiwan)	tlt	(74H) (6CH) (74H)
momme	mom	(6DH) (6FH) (6DH)
tola	tol	(74H) (6FH) (6CH)
parts counting	pcs	(70H) (63H) (73H)
percentage weighing	%△△	(25H) (20H) (20H)
unit converting	#△△	(23H) (20H) (20H)

* When the output is unstable, a unit (three characters) may be a space (20H).

- <CR><LF>: terminator

Example:

```
[123.4567g]      : +△123.4567△g△△<CR><LF>
[o-Err]          : △△△△△△H△△△△△△△<CR><LF>
[u-Err]          : △△△△△△L△△△△△△△△<CR><LF>
                  six characters  seven characters
```

17.6.2 Special format 2

This output format is applied when [7. I.F. 42] is selected in Function 1.

1	2	3	4	5	6	7	8	9	10	11	12	13	14	15	16	17	18	19	20
S1	S2	S3	SP	D1	D2	D3	D4	D5	D6	D7	D8	D9	D10	SP	U1	U2	U3	CR	LF
Stability information			Space	Measurement data (including polarity and decimal point)										Space	Unit (One to three characters)			Terminator	

- S1-S3 (three character): Stable: [S△S] (53H) (20H) (53H), Unstable: [S△D]: (53H) (20H) (44H)
- SP (One character): Space [] (20H)
- D1-D10 (10 character): Set value error Polarity plus/zero: Space [] (20H), Minus: [−] (2DH)
numerical value [0 to 9] (30H–39H), and decimal point (2EH)

* Numerical values are right-aligned.

A space (20H) is used when there is no numerical value.

- SP(One character) : Space[](20H)
- U1-U3 (One to three character): Unit

(**H) : ASCII code △ : Space

Unit	Output	ASCII code
mg	mg	(6DH) (67H)
g	g	(67H)
carat	ct	(63H) (74H)
ounce	oz	(6FH) (7AH)
pound	lb	(6CH) (62H)
troy ounce	ozt	(6FH) (7AH) (74H)
penny weight	dwt	(64H) (77H) (74H)
grain	gr	(67H) (72H)
tael(Hong Kong)	tlh	(74H) (6CH) (68H)
tael(SG)	tls	(74H) (6CH) (73H)
tael(Taiwan)	tlt	(74H) (6CH) (74H)
momme	mom	(6DH) (6FH) (6DH)
tola	tla	(74H) (6CH) (61H)
parts counting	pcs	(70H) (63H) (73H)
percentage weighing	%	(25H)
unit converting	#	(23H)

* This format has a variable length, with the number of characters varying from one to three depending on the unit.

- <CR><LF>: terminator

Example:

[123.4567g] : S△S△△△123.4567△g<CR><LF>

[o-Err] : S△+<CR><LF>

[u-Err] : S△-<CR><LF>

18 Use Printers

18.1 Setting up the Printer



- (1) Use CSP-160 with the balance.
- (2) Set proper print functions (print control) with the balance referring to the instruction manual for your printer.
The factory default of our printer is manual printing (printer control).
- (3) Make the baud rate and other settings compatible between the balance and the printer.

18.2 Outputting calibration results

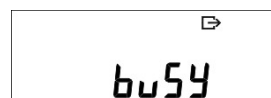
1. Set Function 1.
Set the ISO/GLP/GMP-compatible item to [F. GLP 1] and the GLP-compatible item for measurement data to [F1. out 1].
2. Performs span adjustment/span test.
The data is output in a GLP-compatible manner with [buSy ] displayed when span adjustment is completed, or with the weight error remaining displayed when a span test is completed.
While the data is being output, the balance may seem to not be moving but this does not mean it has malfunctioned. Wait until the output is completed.



18.3 Output of Measurement Data in Compliance with ISO/GLP/GMP

1. Set Function 1.
Set the ISO/GLP/GMP-compatible item to [F. GLP 1] and the GLP-compatible item for measurement data to [F2. od. 1].
2. Header output.
Press and hold the  key for a few seconds. [HEAd] is displayed and the header is then output.
3. Measurement data output.
Measurement data can be output at any time during measurements.
4. Footer output.
Press and hold the  key for a few seconds after the measurement is completed. The display indicates [Foot] and a footer is output.



Continuous press



Continuous press



Caution

- (1) Upon printing calibration/span test results or ISO/GLP/GMP compatible outputs, date and time data is also printed.
Check the date and time set in the balance before printing. (Refer to Section 15: Date and Time Setup on page 49).
- (2) Do not press any keys on the printer during printing. Refer to Section 19 “Output in Compliance with ISO/GLP/GMP” described from page 70 for sample prints.
- (3) While the data is being output in a special format, the measurement data cannot be printed.

19 Output in Compliance with ISO/GLP/GMP

When a span adjustment or span test is successfully completed, the results are printed in the following manner. The printed items vary with the model and calibration methods. ERR and weight error lines are printed only when weight error is selected in Function 2.

(1) Span adjustment using built-in weights

English	Japanese (Katakana)
CALIBRATION	*** コウセイ ***
DATE: 08. 08. 2008	ヒツケ: 2008. 08. 08
TIME: 13:30	ジヨク: 13:30
SHINKO DENSHI	SHINKO DENSHI
TYPE: HTR-220CE	カタシキ: HTR-220CE
S/N: 7300501	セイハン: 7300501
ID: 101	ID: 101
CAL. INTERNAL	コウセイ(ナイフ フントウ)
REF: 220.0000 g	キジュン: 220.0000 g
COMPLETE	シュウリョウ
DATE: 08. 08. 2008	ヒツケ: 2008. 08. 08
TIME: 13:31	ジヨク: 13:31
SIGNATURE	シヨメイ
*****	*****

(2) Span adjustment with external weight

English	Japanese (Katakana)
CALIBRATION	*** コウセイ ***
DATE: 08. 08. 2008	ヒツケ: 2008. 08. 08
TIME: 13:30	ジヨク: 13:30
SHINKO DENSHI	SHINKO DENSHI
TYPE: HTR-220CE	カタシキ: HTR-220CE
S/N: 7300501	セイハン: 7300501
ID: 101	ID: 101
CAL. EXTERNAL	コウセイ(カ イフ フントウ)
REF: 220.0000 g	キジュン: 200.0000 g
ERR: 3.21mg	キサ: 3.21mg
COMPLETE	シュウリョウ
DATE: 08. 08. 2008	ヒツケ: 2008. 08. 08
TIME: 13:31	ジヨク: 13:31
SIGNATURE	シヨメイ
*****	*****

(3) Span test using built-in weights

English

```

**CAL. TEST*****
DATE:08. 08. 2008
TIME:    13:30
  SHINKO DENSHI
TYPE:
  HTR-220CE
S/N:    7300501
ID:      101

CAL. INT. TEST
REF:
  220.0000 g
DIFF:
  0.0081 g

COMPLETE
DATE:08. 08. 2008
TIME:    13:31

SIGNATURE

*****

```

Japanese (Katakana)

```

***   テスト   ***
ヒツケ:2008. 08. 08
ジコク:    13:30
  SHINKO DENSHI
カタシキ:
  HTR-220CE
セイバン:  7300501
ID:        101

テスト(ナイフ フントウ)
キシユン:
  220.0000 g
ゴサ:
  0.0081 g

シュウリョウ
ヒツケ:2008. 08. 08
ジコク:    13:31

シヨメイ

*****

```

(4) Span test with external weight

English

```

**CAL. TEST*****
DATE:08. 08. 2008
TIME:    13:30
  SHINKO DENSHI
TYPE:
  HTR-220CE
S/N:    7300501
ID:      101

CAL. EXT. TEST
REF:
  200.0000 g
ERR:    3.21mg
DIFF:
  0.0081 g

COMPLETE
DATE:08. 08. 2008
TIME:    13:31

SIGNATURE

*****

```

Japanese (Katakana)

```

***   テスト   ***
ヒツケ:2008. 08. 08
ジコク:    13:30
  SHINKO DENSHI
カタシキ:
  HTR-220CE
セイバン:  7300501
ID:        101

テスト(ガ イフ フントウ)
キシユン:
  200.0000 g
キサ:    3.21mg
ゴサ:
  0.0081 g

シュウリョウ
ヒツケ:2008. 08. 08
ジコク:    13:31

シヨメイ

*****

```

(5) Calibration with built-in weight

English

```
****REF. CAL****  
DATE:08.08.2008  
TIME: 13:30  
SHINKO DENSHI  
TYPE:  
HTR-220CE  
S/N: 7300501  
ID: 101  
  
REF:  
220.0000 g  
ERR: 3.21mg  
  
COMPLETE  
DATE:08.08.2008  
TIME: 13:31  
  
SIGNATURE  
  
*****
```

Japanese (Katakana)

```
*ナイブ フント ウコウセイ*  
ヒツケ:2008.08.08  
ジコク: 13:30  
SHINKO DENSHI  
カタシキ:  
HTR-220CE  
セイハン: 7300501  
ID: 101  
  
キシ ユン:  
220.0000 g  
キサ: 3.21mg  
  
シュウリョウ  
ヒツケ:2008.08.08  
ジコク: 13:31  
  
シヨメイ  
  
*****
```

(6) Measurement data

1) Header

English

```
SHINKO DENSHI  
TYPE:  
HTR-220CE  
S/N: 7300501  
ID: 101  
  
START  
DATE:08.08.2008  
TIME: 13:30
```

Japanese (Katakana)

```
SHINKO DENSHI  
カタシキ:  
HTR-220CE  
セイハン: 7300501  
ID: 101  
  
カイシ  
ヒツケ:2008.08.08  
ジコク: 13:30
```

2) Footer

English

```
END  
DATE:08.08.2008  
TIME: 14:30  
  
SIGNATURE  
  
*****
```

Japanese (Katakana)

```
シュウリョウ  
ヒツケ:2008.08.08  
ジコク: 14:30  
  
シヨメイ  
  
*****
```

20 Removing the Windshield Door

20.1 Removing the Windshield Door

1. Remove the pan and pan base.

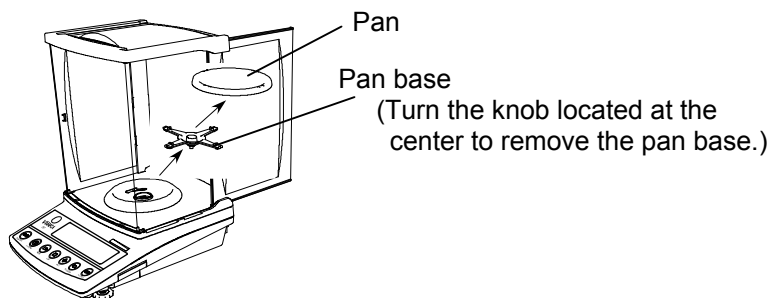

2. Turn the windshield ring counterclockwise until it stops.

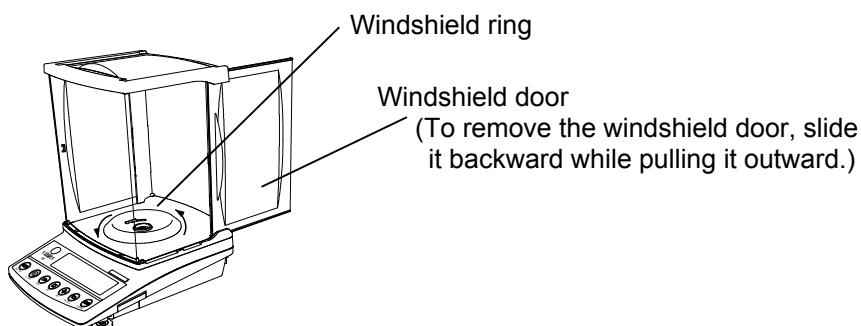

3. Pull the windshield straight up to remove it.

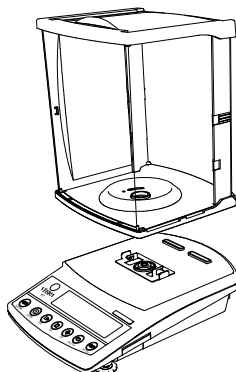

When the windshield is removed, take care that no dust or liquid gets in the balance.

- * When installing the windshield, firmly secure it to the main body of the balance so that it does not fall off.

20.2 Caring for the balance

Clean the windshield and main body of the balance by wiping them with a damp, soft cloth. Do not use items such as chemical agents, solvents, or wipes that could damage the windshield panel.

Contact your local dealer, if you need to replace the windshield.

21 Troubleshooting

* Parentheses contain a page to refer to.

Symptom	Cause	Measures to Take
No display	<ul style="list-style-type: none"> The AC adapter is not connected. 	→ Ensure that the AC adapter is connected.
The display is unstable. The display takes time to be stabilized. The display does not move with the M sign flashing.	<ul style="list-style-type: none"> The balance is influenced by wind or vibration. The balance is placed on an unstable base. The pan, tare, or sample put on the balance is in contact with an external object. 	→ Read Precautions Relating to Use (pages 3 to 6). Adjust the response using the single-touch response setting function (page 12).
Weight indication contains an error.	<ul style="list-style-type: none"> The display error is caused because the balance has not been used for a long period of time or has been relocated to another location. The adjusters are not settled, and the balance is not kept horizontal. The tare weight is set or not. 	→ Perform span adjustment of the balance (page 44). → Check that the balance is kept horizontal (page 10). → Set the tare range correctly.
The balance cannot be calibrated. (An error message appears.)	<ul style="list-style-type: none"> The balance is affected by wind or vibration. There is large weight error for the external reference weights. Mechanical parts have failed. 	→ Check how to calibrate the balance before performing calibration. Refer to Hints on page 46.
[o-Err] is displayed.	<ul style="list-style-type: none"> The measured weight exceeds the weighing capacity. (Measurable range = Weight of container + Weight of samples) Mechanical parts fail. 	→ Check the total weight. → Change the container.
[u-Err] is displayed.	<ul style="list-style-type: none"> The pan or pan base is removed. Mechanical parts have failed. 	→ Install the pan and pan base properly.
[C2-Err] is displayed.	<ul style="list-style-type: none"> The backup battery to power the clock has run out. 	→ Reset the date and time. If an error message appears frequently, contact the local dealer from whom the balance was purchased.
[b-Err] is displayed. [d-Err] is displayed.	<ul style="list-style-type: none"> The balance is influenced by static electricity or noise. The electric components of the balance have failed. 	→ Contact our local dealer.
[A-Err] is displayed.	The built-in weight or drive unit has failed.	→ Contact our local dealer.

22 Specifications

22.1 Basic Specifications

Model Item	HTR-80CE HT84RCE	HTR-120CE HT124RCE	HTR-220CE HT224RCE	HT-80CE HT84CE	HT-120CE HT124CE	HT-220CE HT224CE
Weighing capacity	80 g	120 g	220 g	80 g	120 g	220 g
Minimum capacity	0.01g	0.01g	0.01g	0.01g	0.01g	0.01g
Verification scale interval	0.001g	0.001g	0.001g	0.001g	0.001g	0.001g
Actual scale interval	0.0001 g	0.0001 g	0.0001 g	0.0001 g	0.0001 g	0.0001 g
Minimum unit weight (for parts counting)	0.0001g	0.0001 g	0.0001 g	0.0001 g	0.0001 g	0.0001 g
Lower weight limit (for percent balance)	0.01 g	0.01 g	0.01 g	0.01 g	0.01 g	0.01 g
Built-in weights	Equipped			Unequipped		
Accuracy class	Class I					
Dimensions of the pan	φ80 mm					

- (1) Weighing system Tuning fork system
- (2) Tare range Full capacity
- (3) Display The LCD segment can display up to eight digits.
The segment is 16.5 mm high, and displays 8 digits for a weight.
Can display a bar graph of up to 40 bars and various messages.
- (4) Display when overloaded [o-Err] is displayed when the weighing capacity is exceeded by 9 divisions.
- (5) Output Bi-direction RS232C output, output for peripherals
- (6) Supported printer CSP-160 II
- (7) Temperature and humidity ranges ... 10 to 30°C, 80% rh or lower
- (8) AC adapter Dedicated AC adapter: 120V AC / 9V - 12V DC, or
230V AC / 9V - 12V DC
- (9) Options • Specific gravity measurement kit

22.2 Weighing Capacity and Minimum Readability by Unit

The view of the table

Top line:	Capacity
Middle line:	Verification scale interval
Bottom line:	Auxiliary scale interval

Unit \ Model	HT(R)-80CE HT84(R)CE	HT(R)-120CE HT124(R)CE	HT(R)-220CE HT224(R)CE
mg	80000	120000	220000
	1	1	1
	0.1	0.1	0.1
gram (g)	80	120	220
	0.001	0.001	0.001
	0.0001	0.0001	0.0001
carat (ct)	400	600	1100
	0.01	0.01	0.01
	0.001	0.001	0.001
ounce (oz)	2.8	4.2	7.7
	0.0001	0.0001	0.0001
	0.00001	0.00001	0.00001
pound (lb)	0.17	0.26	0.48
	0.00001	0.00001	0.00001
	0.000001	0.000001	0.000001
troy ounce (ozt)	2.5	3.8	7
	0.0001	0.0001	0.0001
	0.00001	0.00001	0.00001
penny weight (dwt)	51	77	140
	0.001	0.001	0.001
	0.0001	0.0001	0.0001
grain (GN)	1200	1800	3300
	0.1	0.1	0.1
	0.01	0.01	0.01
tael (tl) (Hong Kong)	2.1	3.2	5.8
	0.0001	0.0001	0.0001
	0.00001	0.00001	0.00001
tael (tl) (Singapore, Malaysia)	2.1	3.1	5.8
	0.0001	0.0001	0.0001
	0.00001	0.00001	0.00001
tael (tl) (Taiwan)	2.1	3.2	5.8
	0.0001	0.0001	0.0001
	0.00001	0.00001	0.00001
momme (mom)	21	32	58
	0.001	0.001	0.001
	0.0001	0.0001	0.0001
tola (to)	6.8	10	18
	0.0001	0.0001	0.0001
	0.00001	0.00001	0.00001

23 Unit Conversion Table

Unit	gram	carat	ounce	pound	troy ounce	penny weight
1g	1	5	0.03527	0.00220	0.03215	0.64301
1ct	0.2	1	0.00705	0.00044	0.00643	0.12860
1oz	28.34952	141.74762	1	0.06250	0.91146	18.22917
1lb	453.59237	2267.96185	16	1	14.58333	291.66667
1ozt	31.10348	155.51738	1.09714	0.06857	1	20
1dwt	1.55517	7.77587	0.05486	0.00343	0.05	1
1GN	0.06480	0.32399	0.00229	0.00014	0.00208	0.04167
1tl (Hong Kong)	37.429	187.145	1.32027	0.08252	1.20337	24.06741
1tl (SGP,Mal)	37.79936	188.99682	1.33333	0.08333	1.21528	24.30556
1tl (Taiwan)	37.5	187.5	1.32277	0.08267	1.20565	24.11306
1mom	3.75	18.75	0.13228	0.00827	0.12057	2.41131
1to	11.66380	58.31902	0.41143	0.02571	0.37500	7.5

Unit	grain	tael (Hong Kong)	tael (Singapore, Malaysia)	tael (Taiwan)	momme	tola
1g	15.43236	0.02672	0.02646	0.02667	0.26667	0.08574
1ct	3.08647	0.00534	0.00529	0.00533	0.05333	0.01715
1oz	437.5	0.75742	0.75	0.75599	7.55987	2.43056
1lb	7000	12.11874	12	12.09580	120.95797	38.88889
1ozt	480	0.83100	0.82286	0.82943	8.29426	2.66667
1dwt	24	0.04155	0.04114	0.04147	0.41471	0.13333
1GN	1	0.00173	0.00171	0.00173	0.01728	0.00556
1tl (Hong Kong)	577.61774	1	0.99020	0.99811	9.98107	3.20899
1tl (SGP,Mal)	583.33333	1.00990	1	1.00798	10.07983	3.24074
1tl (Taiwan)	578.71344	1.00190	0.99208	1	10	3.21507
1mom	57.87134	0.10019	0.09921	0.1	1	0.32151
1to	180	0.31162	0.30857	0.31103	3.11035	1

