

















USER MANUAL
MS4900
Stand-on Floor Scale



Please keep the instruction manual at hand all the time for future reference.

Explanation of Graphic Symbols on Label/Packaging

	<p>Caution, consult accompanying documents before use</p>		<p>Separate collection for waste of electrical and electronic equipment, in accordance with Directive 2002/96/EC</p>
	<p>Manufacturer of medical device</p>		<p>Manufacturing year of medical device</p>
	<p>Carefully read user manual before installation and usage, and follow instructions for use.</p>		<p>Medical electrical equipment part with Type B applied part</p>
	<p>Device catalogue number</p>		<p>Authorized representative in the European Community</p>
	<p>Manufacturer's batch or lot number</p>		<p>Device is a medical device</p>
	<p>Serial number</p>		<p>Unique Device Identifier</p>
		<p>Device conforms to 93/42/EEC as amended by 2007/47/EC Medical Device Directive. Four digit number refers to Notified Body.</p>	
		<p>Device complies with International Organization of Legal Metrology (Class III) requirements (verified models only)</p>	
		<p>Device complies with EC directives (verified models only)</p> <p>M: Conformity label in compliance with Directive 2014/31/EU for non-automatic weighing instruments</p> <p>18: Year in which conformity verification was performed and the CE label was applied. (ex: 18=2018)</p> <p>0122: Refers to Notified Body for metrology</p>	

Copyright Notice

Charder Electronic Co., Ltd.

No.103, Guozhong Rd., Dali Dist., Taichung City 41262 Taiwan

Tel: +886-4-2406 3766

Fax: +886-4-2406 5612

Website: www.chardermedical.com E-mail: info_cec@charder.com.tw

Copyright© Charder Electronic Co., Ltd. All rights reserved.

This user manual is protected by international copyright law. All content is licensed, and usage is subject to written authorization from Charder Electronic Co., Ltd. (hereinafter Charder) Charder is not liable for any damage caused by a failure to adhere to requirements stated in this manual. Charder reserves the right to correct misprints in the manual without prior notice, and modify the exterior of the device for quality purposes without customer consent.



Charder Electronic Co., Ltd.
No. 103, Guozhong Rd., Dali Dist.,
Taichung City, 41262 Taiwan

CONTENTS

I. Safety Notes	5
A. General Information	5
B. EMC Guidance and Manufacturer's Declaration	8
II. Installation.....	12
A. Assembly	12
B. Inserting Batteries	15
C. Using Adapter	16
D. Attaching Height Rod to Column	17
E. Attaching Thermal Printer	20
III. Indicator.....	23
A. Indicator and Key Functions	23
B. Display layout.....	24
IV. Using Device	25
A. Basic Operation	25
B. Hold	25
C. BMI	26
D. Tare	26
E. Print.....	26
V. Device Setup	27
VI. Setup RS232 Connection to PC.....	28
VII. Troubleshooting	30
VIII. Product Specifications	32
Standard Accessories	33
IX. Declaration of Conformity	36



I. Safety Notes

A. General Information

Thank you for choosing this Charder Medical device. It is designed to be easy and straightforward to operate, but if you encounter any problems not addressed in this manual, please contact your local Charder service partner.

Before beginning operation of the device, please read this user manual carefully, and keep it in a safe place for reference. It contains important instructions regarding installation, proper usage, and maintenance.

Intended Use

This device is intended to measure the weight of subjects who can stand unassisted, for diagnosis of weight-related issues by professionals..

General Handling

- Device should be placed on stable, flat, solid, non-slippery surface.
- Usage on soft surfaces (ex: carpet) may result in inaccurate results.
- Ensure all parts are properly locked and tightened before operating the device.
- Device is intended to measure one subject at a time.

Safety Instructions

- Batteries should be kept away from children. If swallowed, promptly seek medical assistance.
- Expected service life: 5 years.
- Always comply with appropriate regulations when using electrical components under increased safety requirements.
- Ensure voltage marked on power supply matches mains power supply.
- The device is intended for indoor use only.
- Observe permissible ambient temperatures for use

Environmental

- All batteries contain toxic compounds; batteries should be disposed of via designated competent organizations. Batteries should not be incinerated.

Cleaning

- Device surface should be cleaned using alcohol-based wipes. Corrosive cleansing liquids should not be used. Pressure-washers

should not be used.

- Do not use large amounts of water when cleaning the device, as it may cause damage to the internal electronics.
- Always disconnect device from mains power before cleaning.

Maintenance

- Device does not require routine maintenance. However, regular checking of accuracy is recommended; frequency to be determined by level of use and state of device. If results are inaccurate, please contact local distributor.

Warranty/Liability

- The period of warranty shall be eighteen (18) months, beginning on the date of purchase. Please retain your receipt as proof of purchase.
- No responsibility shall be accepted for damage caused through any of the following reasons: unsuitable or improper storage or use, incorrect installation or commissioning by the owner or third parties, natural wear and tear, changes or modifications, incorrect or negligent handling, chemical, electrochemical, or electrical interference.
- All maintenance, technical inspections, and repairs should be conducted by an authorized Charder service partner, using original Charder accessories and spare parts. Charder is not liable for any damages arising from improper maintenance or usage.

Disposal

- This product is not to be treated as regular household waste, but should be taken to a designated collection points for electronics. Further information should be provided by local waste disposal authorities.



Warning

- Only the original adapter should be used with the device. Using an adapter other than the one provided by Charder may cause malfunction.
- Do not touch the power supply with wet hands.
- Do not crimp the power cable, and avoid sharp edges.
- Do not overload extension cables connected to the device.
- Route cables carefully, to avoid tripping.
- Keep device away from liquids.
- Do not remove the plug by yanking on the cable.
- Use only a correctly wired (100-240VAC) outlet, and do not use a

multiple outlet extension cable.

- Do not under any circumstances dismantle or alter the device, as this could result in electric shock or injury as well as adversely affect the precision of measurements.
- Do not place the device in direct sunlight, or in close proximity to an intense heat source. Excessively high temperatures may damage the internal electronics.

Incident Reporting

- Any serious incident that has occurred in relation to the device should be reported to the manufacturer, EU representative (if device is used in EU member state), and competent authority of user/subject's member state.

B. EMC Guidance and Manufacturer's Declaration

Guidance and manufacturer's declaration-electromagnetic emissions		
The MS4900 Stand-on Floor Scale is intended for use in the electromagnetic environment specified below. The customer or the user of the device should assure that it is used in such an environment.		
Emission test	Compliance	Electromagnetic environment-guidance
RF emissions CISPR 11	Group 1	The device uses RF energy only for its internal function. Therefore, its RF emissions are very low and are not likely to cause any interference in nearby electronic equipment.
RF emissions CISPR 11	Class B	The device is suitable for use in all establishments, including domestic establishments and those directly connected to the public low-voltage power supply network that supplies buildings used for domestic purposes.
Harmonic emissions IEC 61000-3-2	Class A	
Voltage fluctuations /flicker emissions IEC 61000-3-3	Compliance	

Guidance and manufacturer's declaration-electromagnetic immunity			
The MS4900 Stand-on Floor Scale is intended for use in the electromagnetic environment specified below. The customer or the user of the device should assure that it is used in such an environment.			
Immunity test	IEC 60601 test level	Compliance level	Electromagnetic environment-guidance
Electrostatic discharge(ESD) IEC 61000-4-2	<u>± 8 kV contact</u> <u>± 2 kV, ± 4 kV,</u> <u>± 8 kV, ± 15 kV</u> <u>air</u>	<u>± 8 kV contact</u> <u>± 2 kV, ± 4 kV,</u> <u>± 8 kV, ± 15 kV</u> <u>air</u>	Floors should be wood, concrete or ceramic tile. If floors are covered with synthetic material, the relative humidity should be at least 30%

Electrical fast transient/burst IEC 61000-4-4	± 2kV for power supply lines + 1kV for input/output lines	+ 2kV for power supply lines + 1kV for input/output lines	Mains power quality should be that of a typical commercial or hospital environment.
Surge IEC 61000-4-5	± 1kV line(s) to line(s) ± 2kV line(s) to earth	+ 1kV line(s) to line(s) + 2kV line(s) to earth	Mains power quality should be that of a typical commercial or hospital environment.
Voltage Dips, short interruptions and voltage variations on power supply input lines IEC 61000-4-11	<u>0% UT for 0,5 cycle</u> <u>0% UT for 1 cycle</u> <u>70% UT(30% dip in UT) for 25 cycles</u> <u>0% UT for 5 s</u>	<u>0% UT for 0,5 cycle</u> <u>0% UT for 1 cycle</u> <u>70% UT(30% dip in UT) for 25 cycles</u> <u>0% UT for 5 s</u>	Mains power quality should be that of a typical commercial or hospital environment. If the user of the device requires continued operation during power mains interruptions, it is recommended that the device be powered from an uninterruptible power supply or a battery.
Power frequency(50/60 Hz) magnetic field IEC 61000-4-8	<u>30 A/m</u>	<u>30 A/m</u>	The device power frequency magnetic fields should be at levels characteristic of a typical location in a typical commercial or hospital environment.
NOTE UT is the a.c. mains voltage prior to application of the test level.			

Guidance and manufacturer's declaration-electromagnetic immunity

The MS4900 Stand-on Floor Scale is intended for use in the electromagnetic environment specified below. The customer or the user of the device should assure that is used in such an environment.

Immunity test	IEC 60601 test level	Compliance level	Electromagnetic environment-guidance
Conducted RF IEC 61000-4-6	3 Vrms 150 KHz to 80 MHz	3 Vrms 150 KHz to 80 MHz	Portable and mobile RF communications equipment should be used no closer to any part of the device including cables, than the recommended separation distance calculated from the equation applicable to
Radiated RF IEC 61000-4-3	<u>6 V in ISM bands between 0,15 MHz and 80 MHz</u> <u>80 % AM at 1 kHz</u> 3 V/m	<u>6 V in ISM bands between 0,15 MHz and 80 MHz</u> <u>80 % AM at 1</u>	

	80MHz to 2,7 GHz	<u>kHz</u> 3 V/m <u>80MHz to 2,7 GHz</u>	the frequency of the transmitter. Recommended separation distance: $d = 1,2 \sqrt{P}$ $d = 1,2 \sqrt{P}$ 80MHz to 800 MHz $d = 2,3 \sqrt{P}$ 800MHz to 2,5 GHz Where P is the maximum output power rating of the transmitter in watts (W) according to the transmitter manufacturer and d is the recommended separation distance in metres (m). Field strengths from fixed RF transmitters, as determined by an electromagnetic site survey ^a , should be less than the compliance level in each frequency range ^b . Interference may occur in the vicinity of equipment marked with the following symbol: 
--	------------------	--	--

NOTE1 At 80 MHz and 800 MHz, the higher frequency range applies.

NOTE2 These guidelines may not apply in all situations. Electromagnetic propagation is affected by absorption and reflection from structures, objects and people.

a Field strengths from fixed transmitters, such as base stations for radio (cellular/cordless) telephones and land mobile radios, amateur radio, AM and FM radio broadcast and TV broadcast cannot be predicted theoretically with accuracy. To assess the electromagnetic environment due to fixed RF transmitters, an electromagnetic site survey should be considered. If the measured field strength in the location in which the device is used exceeds the applicable RF compliance level above, the device should be observed to verify normal operation. If abnormal performance is observed, additional measures may be necessary, such as re-orienting or relocating the device.

b Over the frequency range 150 kHz to 80 MHz, field strengths should be less than 3 V/m.

Recommended separation distance between portable and mobile RF communications equipment and the MS4900 Stand-on Floor Scale

The device is intended for use in an electromagnetic environment in which radiated RF disturbances are controlled. The customer or the user of the device can help prevent electromagnetic interference by maintaining a minimum distance between portable and mobile RF communications equipment (transmitters) and the device as recommended below, according to the maximum output power of the communications equipment.

Rated maximum output power of transmitter W	Separation distance according to frequency of transmitter m		
	150 kHz to 80 MHz $d = 1,2\sqrt{P}$	80 MHz to 800 MHz $d = 1,2\sqrt{P}$	800 MHz to 2,5 GHz $d = 2,3\sqrt{P}$
0,01	0,12	0,12	0,23
0,1	0,38	0,38	0,73
1	1,2	1,2	2,3
10	3,8	3,8	7,3
100	12	12	23

For transmitters rated at a maximum output power not listed above, the recommended separation distance d in metres (m) can be estimated using the equation applicable to the frequency of the transmitter, where p is the maximum output power rating of the transmitter in watts (W) according to the transmitter manufacturer.

NOTE1 At 80 MHz and 800 MHz, the separation distance for the higher frequency range applies.

NOTE2 These guidelines may not apply in all situations. Electromagnetic propagation is affected by absorption and reflection from structures, objects and people.

II. Installation

A. Assembly

Standard Column

1. Fasten and tighten four screws at the bottom of the base. Ensure four adjustable feet and stability foot are at same level before using device.

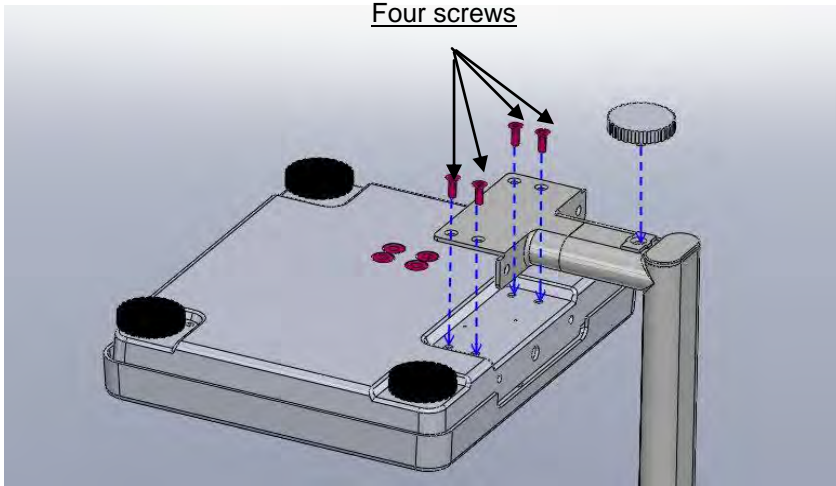

Castor wheel column

1. Fasten and tighten four screws at the bottom of the base

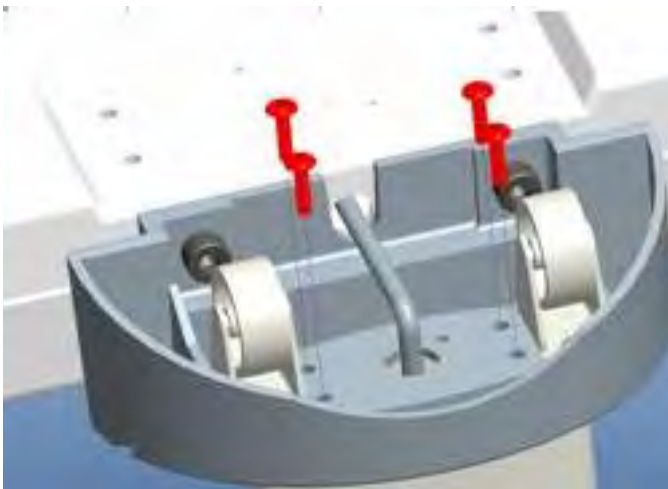

2. Ensure four adjustable feet and stability foot are at the same level before using the device. Rotate counter-clockwise to extend, clockwise to retract

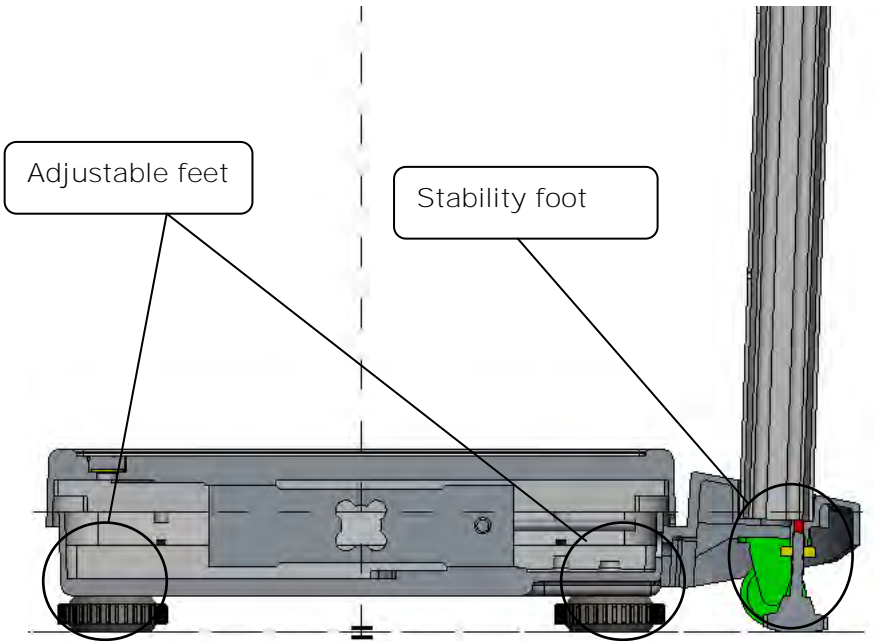
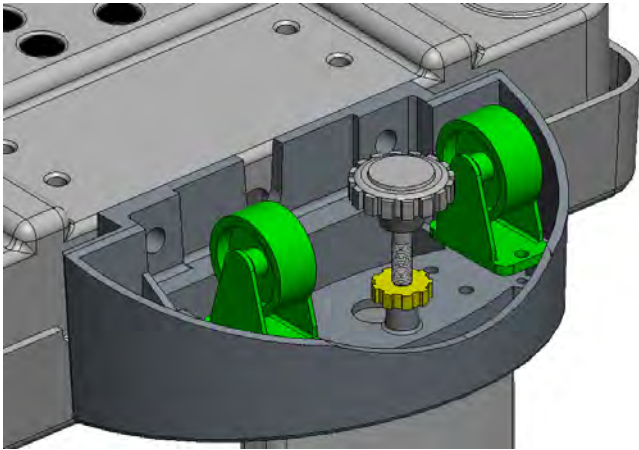

3. Retract stability foot before moving device using castor wheels

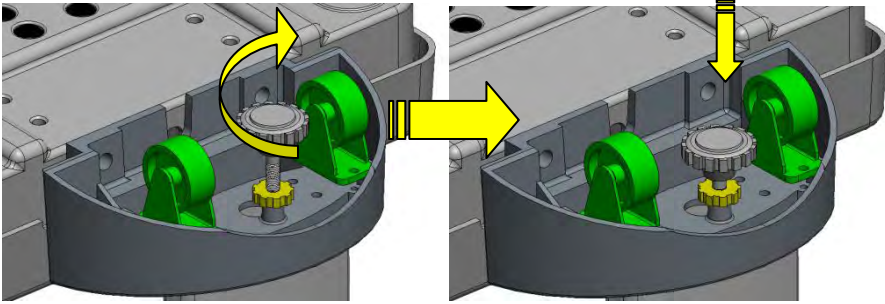

Note: rotate counter-clockwise to extend, clockwise to retract

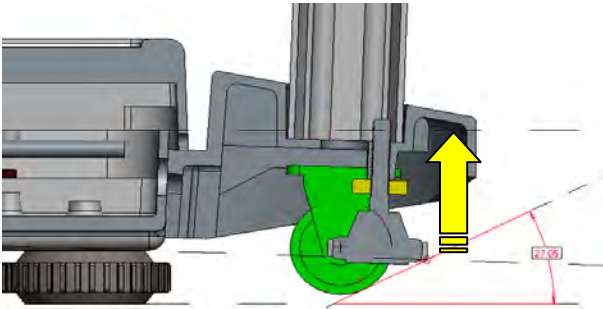

Ensure stability foot is retracted before using castor wheels

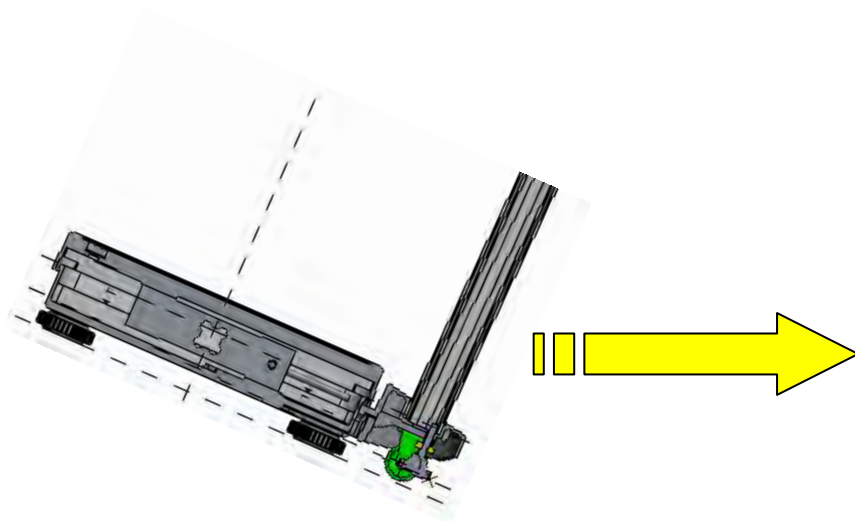

B. Inserting Batteries

1. Open battery housing cover

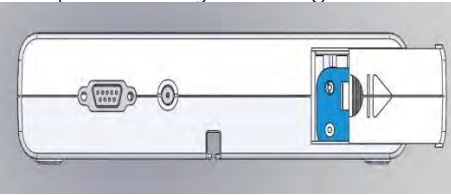

2. Remove battery housing

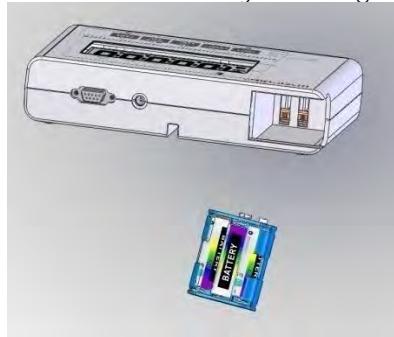

3. Insert batteries



4. When inserting battery housing, ensure contact with housing pins is correct.

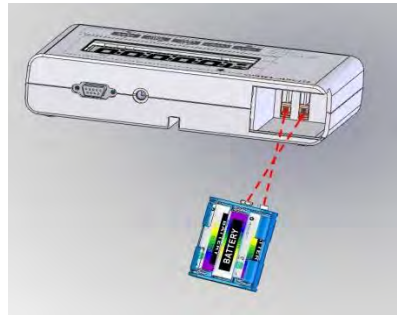

5. Re-insert battery housing.

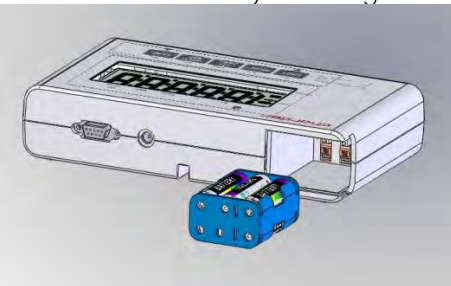

6. Close battery housing cover.



C. Using Adapter

1. Connect adapter to indicator before connecting to mains power supply
2. Disconnect adapter from mains power supply before unplugging adapter pin from indicator.

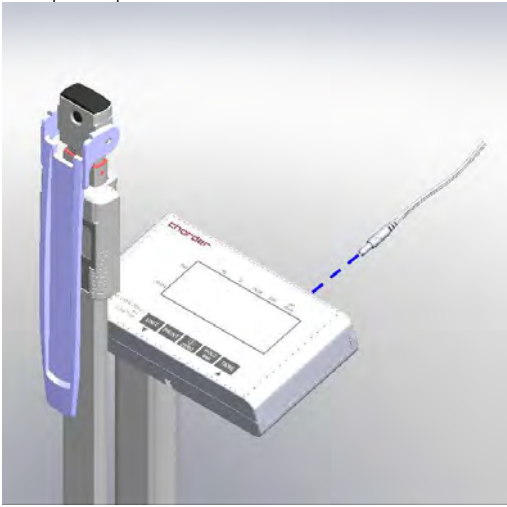

D. Attaching Height Rod to Column

Standard (Narrow) Column

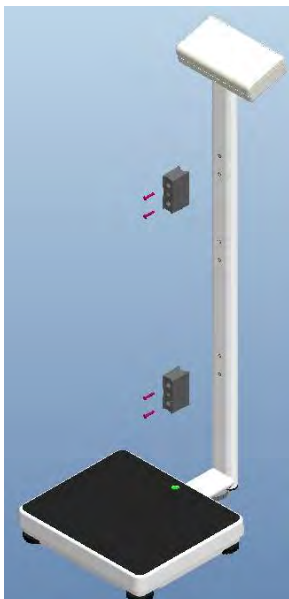

Step 1. Attach two fixing blocks to column using four flat-head screws



Step 2. Attach height rod to blocks using two flat-head screws

Item	Name	Quantity
1	Fixing block screws	4
2	Fixing blocks	2
3	Height Rod to fixing block screws	2

Castor Wheel Column

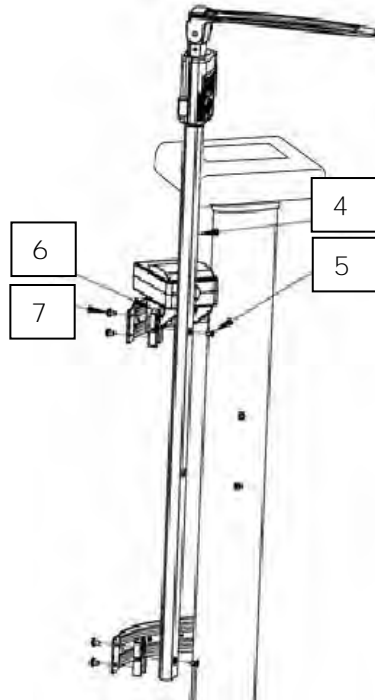
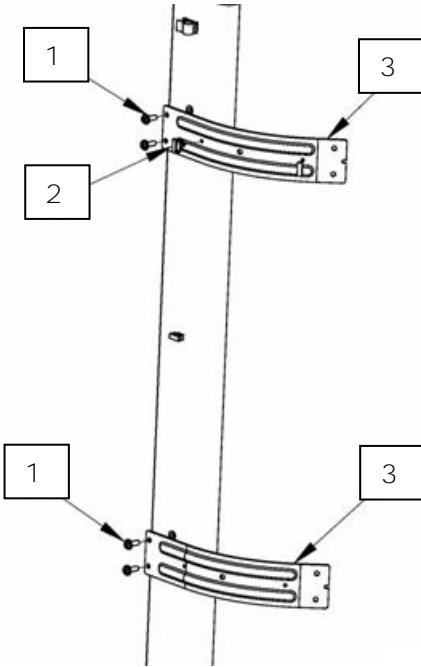

1. Attach brackets to column with round-head screws

2. Attach height rod to brackets using flat-head screws

Item	Name	Quantity
1	M5x0.8x11 round head screw	4
2	Relief Bushing	2
3	Bracket for HM200D/HM201D/HM201M	2
4	Height Rod (Compatible with: HM200D/HM201D/HM201M)	1
5	M5x10L flat head screw	2
6	Fixing block	2
7	M5x0.8x11	4

Connecting height rod to indicator (HM200D/HM201D)

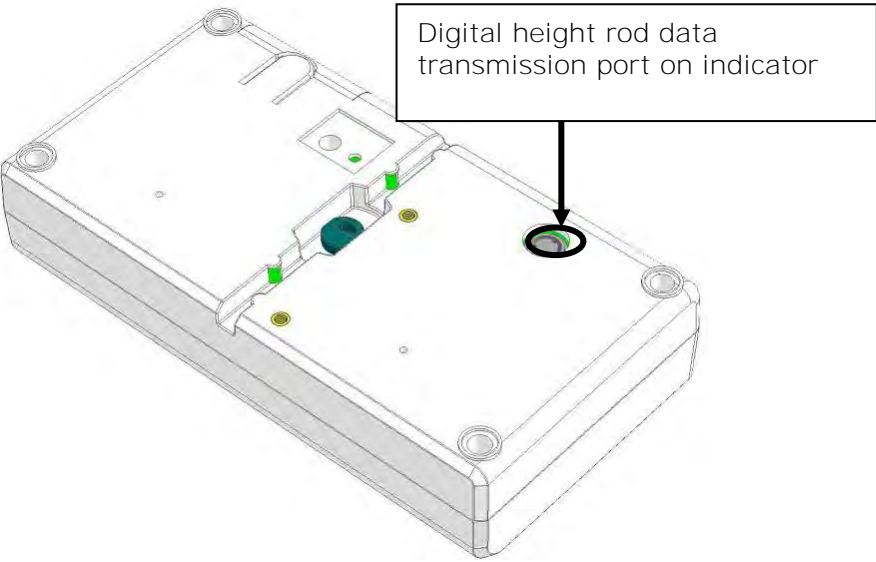
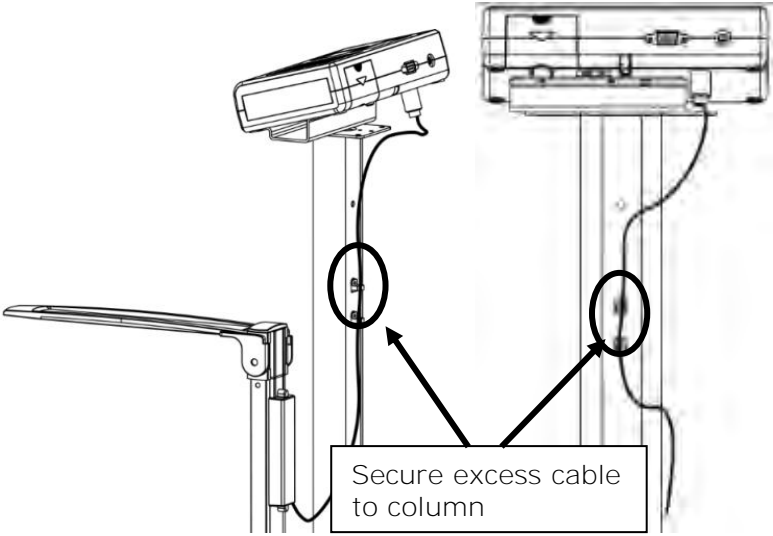

E. Attaching Thermal Printer

Standard (Narrow) Column

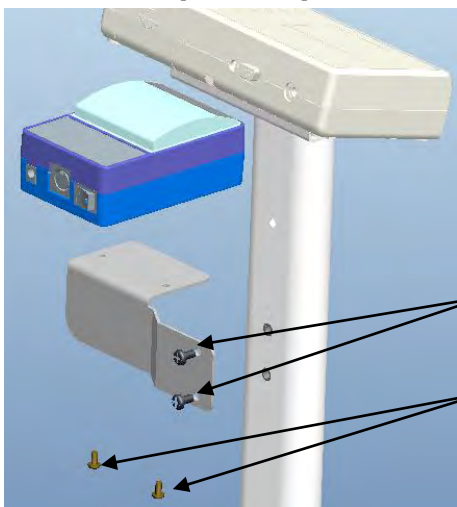

Washer head screw M5*0.8*15mm

Cross head screw M4*0.7*6mm

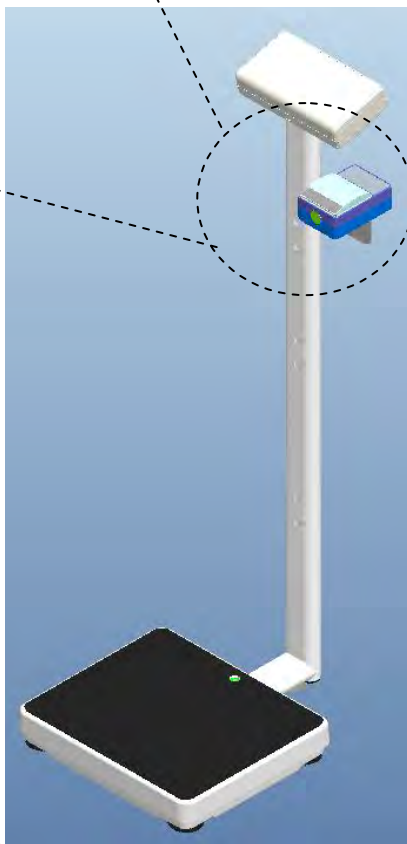

Castor Wheel Column

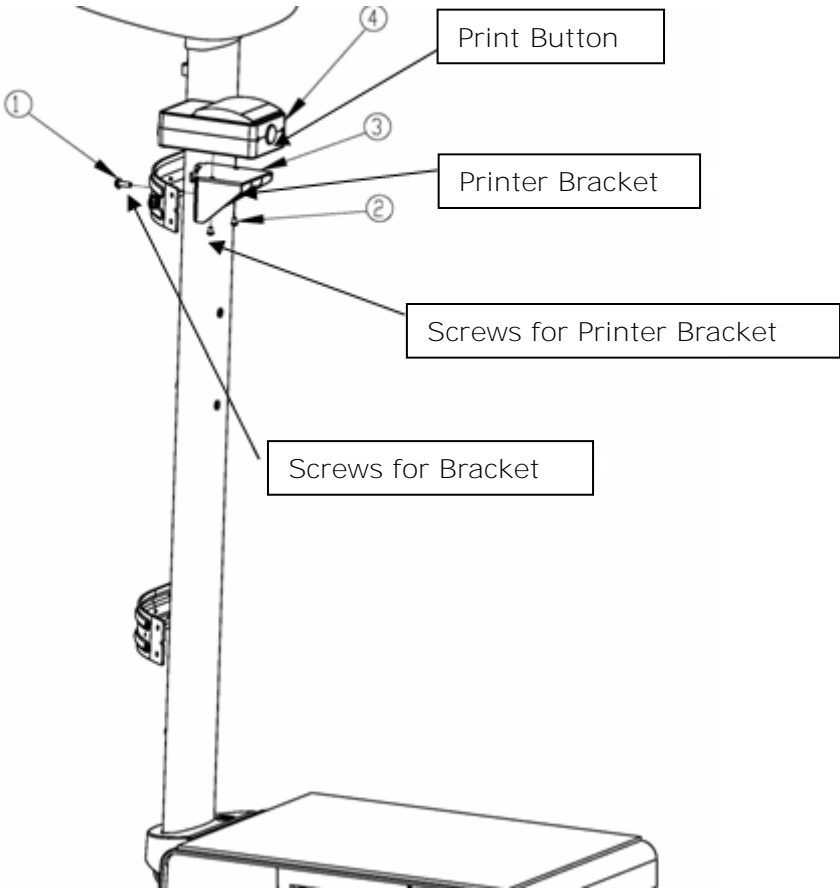

Item	Parts	Qty
1	M5*15L head screw	1
2	Screws for printer bracket	2
3	Printer bracket	1
4	TP2100/TP2110 Thermal Printer	1 (purchased separately)

1. Install the side bracket



2. Install the thermal printer on the bracket

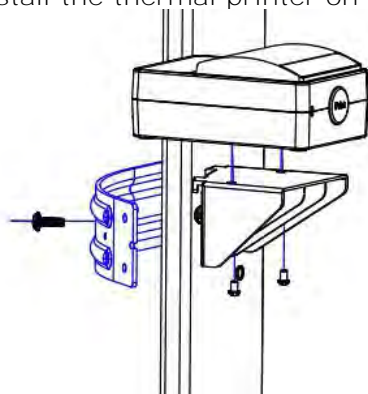



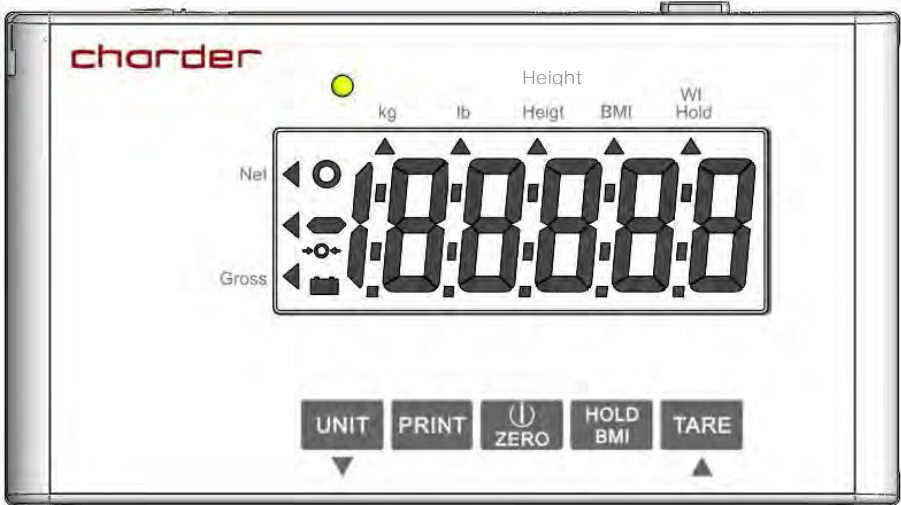

III. Indicator

A. Indicator and Key Functions



(lb not available on OIML-approved model)

Key Function

-  (UNIT): Switch between units. For OIML-approved version, only kg is activated.
-  (PRINT): When printer or PC is connected to the scale, press this key to print results.
-  (ON/OFF/ZERO): Turn device on and off. Press and hold for 3 seconds to turn device off.
-  (HOLD/BMI): Determine stable weighing value - used when weight is unstable. Press and hold for 3 seconds to activate BMI (Body Mass Index) calculation mode.
-  (TARE): Deduct weight from results. Press and hold for 3 seconds to enter settings.

B. Display layout

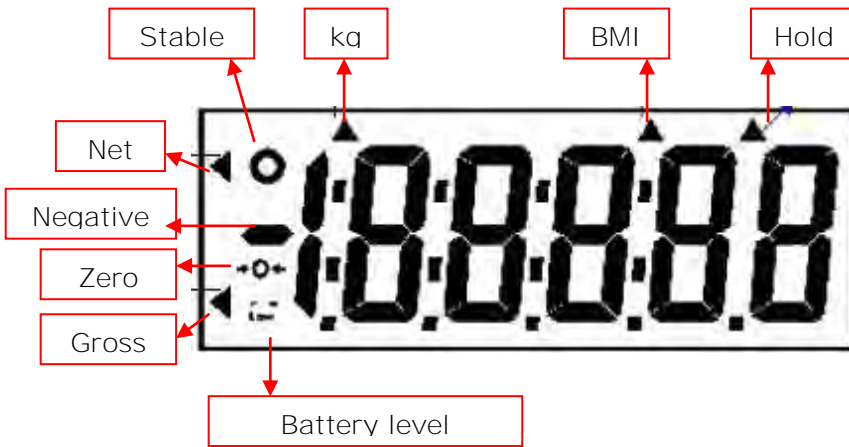

Hold: Hold function is activated

BMI: BMI function is activated

kg: Current unit is kg

Stable: Weight is stable.

Net: Current result is net weight

Negative: Weight is under zero

Zero: Weight is at zero

Gross: Current result is gross weight.

Battery: Battery level. Replace battery when low.

IV. Using Device

A. Basic Operation

Switch on the device using  key. The device will automatically perform self-calibration, displaying software version.

Once "0.00 kg" appears on indicator, device is ready for measurement.

Note: If "0.00 kg" does not display on indicator, press  key to zero the device.



Guide subject to stand upon the measurement platform. After the weight has stabilized, the "stable" symbol will appear on indicator.

Note: If subject's weight exceeds scale capacity (including tare), indicator will display "Err" prompt due to overload.

B. Hold





The hold function determines average weight, designed to be used if subject's weight will not stabilize (ex: an active child).

Note: if fluctuation is too severe, average weight determination will be difficult and hold may not function correctly

1. Switch on the device normally.
2. Press the  key. The triangle next to "HOLD" on the indicator will flash.
3. Guide subject to stand on measurement platform.
4. After a few seconds, the average weight will be displayed on the indicator. This weight will be locked - at this point, subject can step off from device.
5. To release the locked weight, press the  key again to return to the device to normal mode.

Note: Hold function can be activated before or after subject stands on measurement platform. However, if subject finds it difficult to stand still, we recommend activating Hold after subject stands on platform.

C. BMI



1. Weigh subject normally. After "stable" symbol appears on indicator, press the  key to enter BMI mode.
2. Display will show last recorded height. Left-most digit will flash.
3. Enter height using numeral keys (ex: 170 cm). Input will automatically move to next digit. Press  key to decrease, press  key to decrease. (press and hold to speed up)
4. After inputting height, press  to confirm.
5. Indicator will alternate between weight and BMI display.
6. Press  key to return to normal mode.

Category	BMI (kg/m ²)	Risk of obesity-related disease
Under	< 18.5	Low
Normal	18.5-24.9	Average
Over	24.9-29.9	Slightly Increased
Obese I	30.0-34.9	Increased
Obese II	35.0-39.9	High
Obese III	> 40	Very High

(World Health Organization adult BMI standards)

D. Tare

The tare function allows the user to deduct the weight of objects from the device's measurement result.

1. Place object that needs to be tared onto measurement platform.
2. Press  key after stable symbol appears on indicator. Display will indicate "0.00 kg".
3. Guide subject (plus tared object) to be weighed upon measurement platform. Conduct measurement.
4. To clear tare value, remove all objects from measurement platform, and press  key.

E. Print

If thermal printer is connected to indicator via RS232, results can be printed by pressing  key.

V. Device Setup

When the device is switched on, press and hold the  key for about 3 seconds, until the display shows the "SET", followed by "A.OFF" (first option in setting menu).

In device setup menu:



 to toggle menu option

 to confirm selection / enter submenu





Auto Power-Off: Instruct device to shut off automatically after a certain period of time.

Auto off options: 120 sec / 180 sec / 240 sec / 300 sec / off

Press  to toggle between time options, and  to confirm selection.





Adjust count range: This setting is normally used by qualified distributors, and does not need to be changed by users.

Press  to toggle between 2d, 4d, 6d, and 8d. Press  to confirm selection.



Buzzer/Beep:

When function is turned on, beeping noise will be made when: indicator is turned on, keys are pressed, and weight is stable.

Press  to toggle between on/off, and  key to confirm selection.

Note: to confirm settings, press  when **End** appears on display.

VI. Setup RS232 Connection to PC

For successful connection, PC hardware must be connected to device using manufacturer's designated RS232 cable.

1. Hyper Terminal freeware software can be used to connect the device to a PC. The software program can be downloaded from the Charder website:

[LINK URL] <https://www.chardermedical.com/download.htm>

2. Connect RS232 cable to device indicator and PC. Follow installation instructions below:

Program Setup

1. After installation of Hyper Terminal, measurement results can be sent from indicator to PC.

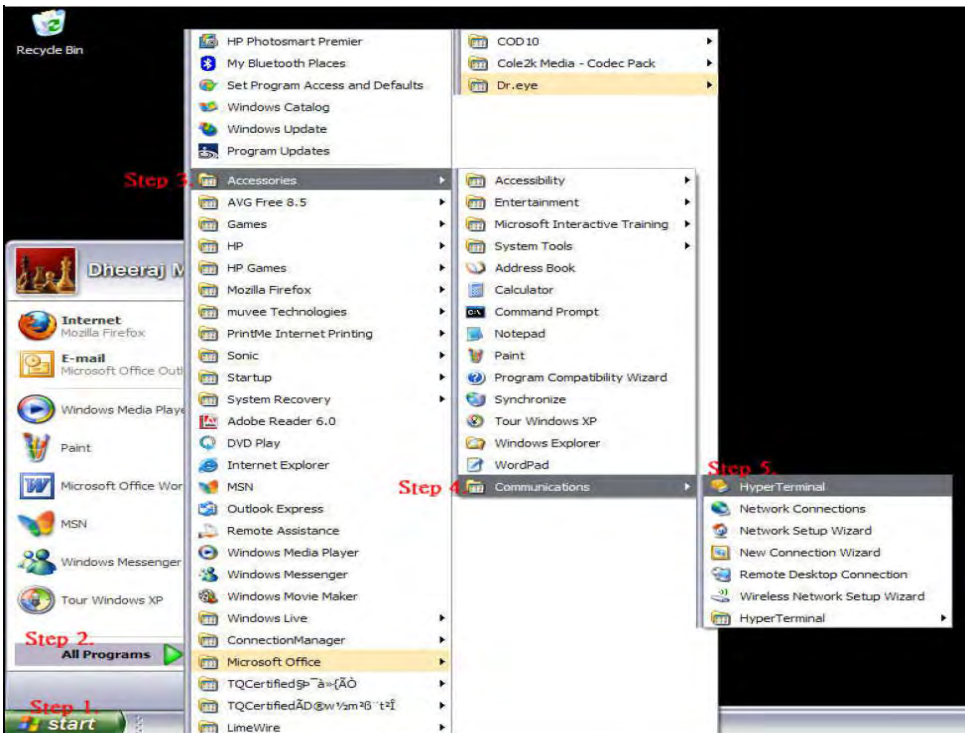

2. Name the connection and click **[OK]**.



3. Select COM (1, 2, 3, 4...) under "Connect using" dropdown menu, and press **[OK]**.

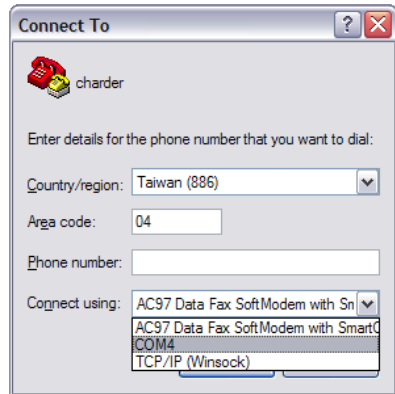

4. Set Port Settings as below:

- Baud rate: 9600 Bits per second
- Data bits: 8
- Parity check: None
- Stop bits: 1
- Handshake: RTS/CTS
- Data code: ASCII

Press **[OK]** to complete setup.

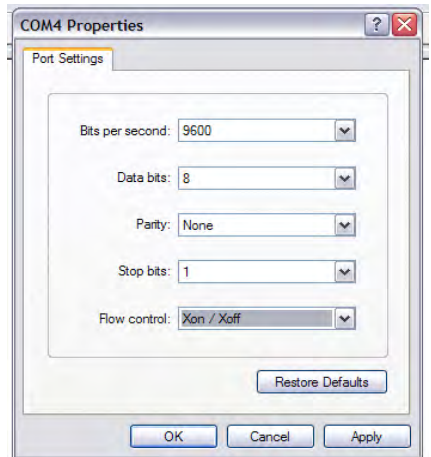

Send results from device to PC

After conducting weight/BMI measurement, press the [PRINT] button the indicator. Results will appear in Hyper Terminal software.

VII. Troubleshooting

Before contacting your local Charder distributor for repair service, we recommend considering the following troubleshooting procedures:

Self-inspection

1. Device will not power on

- If battery power is depleted, replace with new batteries
- If batteries are not used, check if the power adapter is plugged into the device properly. Check if power adapter is plugged into mains properly

2. Indicator showing "0000" ZERO SPAN out of range

- Interference due to factors such as RF disturbance or ground vibration. Relocate device to location without interference and try again
- Unstable platform feet - adjust platform feet according to bubble level indication (clockwise to retract, counter-clockwise to extend) and try again
- External objects interfering with measurement platform. Clear platform of objects and try again
- Device may not function properly on soft surfaces such as carpets or lawns. Relocate device to location with solid, stable floor
- If the steps above cannot resolve the problem, re-calibration may be required to correct weighing accuracy

3. Connection failure for data transmission to PC or printer

- Ensure wires are connected correctly between indicator and PC or printer
- Ensure printer is supplied with power. Ensure PC software is set up properly as indicated in this manual

Distributor support required

If the following errors occur, we recommend contacting your local Charder distributor for repair or replacement services:





1. Device will not power on

- Faulty on/off key
- Broken or damaged wires causing short circuit or faulty connection
- Safety fuse burnout
- Faulty adapter

2. Indicator damage

- Possible hardware defects include: uneven brightness in LCD screen, blurred text, smeared rainbow screen, incorrect decimal display
- Unable to save or read data
- Indicator shows "ERRL" after device is switched on
- Keys not responding
- Buzzer malfunction

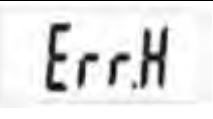
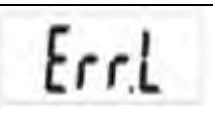
Error Messages

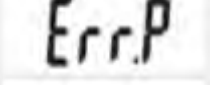
Error Message	Reason	Action
	Low battery warning Voltage of battery is too low to operate device	Replace batteries, or plug in adapter
	Overload Total load exceeds device's maximum capacity	Reduce weight on measurement platform and try again
	Counting Error (too high) Signal from loadcells too high	Error normally caused by faulty loadcell or wiring. Please contact distributor
	Counting Error (too low) Signal from loadcells too low	Error normally caused by faulty loadcell or wiring. Please contact distributor
	Zero count over calibration zero range +10% while power on	Re-calibration required. Please contact distributor
	Zero count under calibration zero range -10% while power on	Re-calibration required. Please contact distributor
	Program Error Fault with device software	Error normally caused by faulty loadcell or wiring. Please contact distributor

VIII. Product Specifications



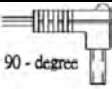

Model		MS4900	
Display		DP3400	
Weight Measurement	Capacity	0-100 kg x 0.1 kg 100-150 kg x 0.2 kg	0-200 kg x 0.2 kg 200-300 kg x 0.5 kg
	Accuracy	± 1.5e	
	OIML	Class III	
	LCD Screen	1.2-inch LCD screen (5 1/2 digits)	
Dimensions (Standard)	Overall	360(W) x 480(D) x 1100(H) mm	
	Platform	360(W) x 310(D) x 70(H) mm	
	Column	1026 mm	
	Device Weight	8.2 kg	
Dimensions (Castor Wheel)	Overall	360(W) x 440(D) x 970(H) mm	
	Platform	360(W) x 310(D) x 70(H) mm	
	Column	850 mm	
	Device Weight	7.8 kg	
Key Functions		On/Off/Zero, Print, Hold/BMI, Tare, Unit (non-OIML approved models)	
Data Transmission		RS232 NOTE: Device should be connected to network by qualified distributors only	
Power Supply		6 AA batteries / Power adapter	
Operation Temperature & Humidity		0°C~40°C 15% / 85% RH	
Standard Accessories		(see accessory list)	
Optional Accessories		Thermal Printer, Height Meter	

 **Warning**

The device is only compatible with the power adapters specified below.

AMP VOLTAGE	DRAWING NO.	CE APPROVED TYPE NO. / MODEL NO.	TYPE	Adapter plug
12V 1A	AD-8095	UE24WCP1-120100SPA	US	 90 - degree
			EU	
			UK	
			AU	

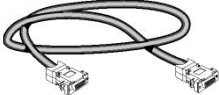
Standard Accessories



No.	Accessories	Item	Spec.	Qty.
1		Standard column: flat head screw	M6 x 20	4
		Castor wheel column: round head screw	M4 x 20	4
2		12V adapter	DC adapter	1
3		RS232 cable	WR-8159	1
4		User manual		1

Notes

Notes

IX. Declaration of Conformity

This product has been manufactured in accordance with the harmonized European standards, following the provisions of the below stated directives:

	93/42/EEC as amended by 2007/47/EC Medical Device Directive
	2014/31/EU Non-automatic Weighing Instruments Directive

Please see separate document showing on sticker of device for above CE marking.

Authorized EU Representative:



Obelis s.a.

Bd Général Wahis, 53
B-1030 Brussels
Belgium



Manufactured by:
Charder Electronic Co., Ltd.
No.103, Guozhong Rd., Dali Dist.,
Taichung City, 41262 Taiwan (R.O.C.)

CD-IN-1089 9077W 04/2021